

**MaxiCOM MK808Z-BT**

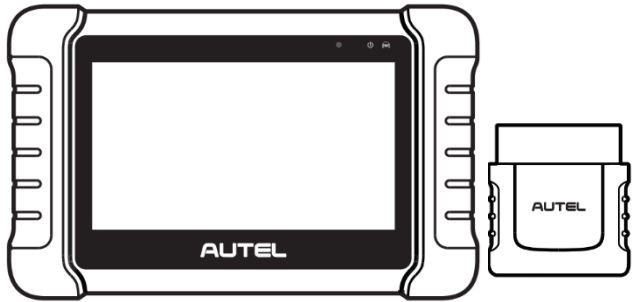

## Trademarks

Autel®, MaxiSys®, MaxiDAS®, MaxiPRO®, MaxiRecorder®, MaxiCOM®, and MaxiCheck® are trademarks of Autel Intelligent Technology Corp., Ltd., registered in China, the United States, and other countries. All other marks are trademarks or registered trademarks of their respective holders.

## Copyright Information

No part of this manual may be reproduced, stored in a retrieval system or transmitted in any form or by any means electronic, mechanical, photocopying, recording, or otherwise without the prior written permission of Autel.

## Disclaimer of Warranties and Limitation of Liabilities

All information, specifications and illustrations in this manual are based on the latest information available at the time of printing.

Autel reserves the right to make changes at any time without notice. While information of this manual has been carefully checked for accuracy, no guarantee is given for the completeness and correctness of the contents, including but not limited to the product specifications, functions, and illustrations.

Autel will not be liable for any direct, special, incidental, or indirect damages, or for any economic consequential damages (including the loss of profits) as a result of using this product.

---

### IMPORTANT

Before operating or maintaining this unit, please read this manual carefully, paying extra attention to the safety warnings and precautions.

---

## For Services and Support



[pro.autel.com](http://pro.autel.com)

[www.autel.com](http://www.autel.com)



1-855-288-3587 (North America)

+86 (0755) 8614-7779 (China)



[support@autel.com](mailto:support@autel.com)

For technical assistance in all other markets, please refer to *Technical Support* in this manual.

## Safety Information

For your own safety and the safety of others, and to prevent damage to the device and vehicles upon which it is used, it is important that the safety instructions presented throughout this manual be read and understood by all persons operating or coming into contact with the device.

There are various procedures, techniques, tools, and parts required for servicing vehicles, as well as the skills of the person doing the work. Because of the vast number of test applications and variations in the products that can be tested with this equipment, we cannot possibly anticipate or provide advice or safety messages to cover every circumstance. It is the automotive technician's responsibility to be knowledgeable of the system being tested. It is crucial to use proper service methods and test procedures. It is essential to perform tests in an appropriate and acceptable manner that does not endanger your safety, the safety of others in the work area, the device being used, or the vehicle being tested.

Before using the device, always refer to and follow the safety messages and applicable test procedures provided by the manufacturer of the vehicle or equipment being tested. Use the device only as described in this manual. Be sure to read, understand, and follow all safety messages and instructions in this manual.

## Safety Messages

Safety messages are provided to help prevent personal injury and equipment damage. All safety messages are introduced by a signal word indicating the hazard level.

---

### **DANGER**

Indicates an imminently hazardous situation which, if not avoided, will result in death or serious injury to the operator or to bystanders.

---

### **WARNING**

Indicates a potentially hazardous situation which, if not avoided, could result in death or serious injury to the operator or to bystanders.

---

## Safety Instructions

The safety messages herein cover situations Autel is aware of at the time of publication. Autel cannot know, evaluate or advise you as to all of the possible hazards. You must be certain that any condition or service procedure encountered does not jeopardize your personal safety.

---

 **DANGER**

When an engine is operating, keep the service area WELL VENTILATED or attach a building exhaust removal system to the engine exhaust system. Engines produce carbon monoxide, an odorless, poisonous gas that causes slower reaction time and can lead to serious personal injury or loss of life.

---

 **SAFETY WARNINGS**

- Always perform automotive testing in a safe environment.
- Wear safety eye protection that meets ANSI standards.
- Keep clothing, hair, hands, tools, test equipment, etc. away from all moving or hot engine parts.
- Operate the vehicle in a well-ventilated work area, for exhaust gases are poisonous.
- Put the transmission in PARK (for automatic transmission) or NEUTRAL (for manual transmission) and make sure the parking brake is engaged.
- Put blocks in front of the drive wheels and never leave the vehicle unattended while testing.
- Be extra cautious when working around the ignition coil, distributor cap, ignition wires and spark plugs. These components create hazardous voltages when the engine is running.
- Keep a fire extinguisher suitable for gasoline, chemical, and electrical fires nearby.
- Do not connect or disconnect any test equipment while the ignition is on or the engine is running.
- Keep the test equipment dry, clean, free from oil, water or grease. Use a mild detergent on a clean cloth to clean the outside of the equipment as necessary.
- Do not drive the vehicle and operate the test equipment at the same time. Any distraction may cause an accident.
- Refer to the service manual for the vehicle being serviced and adhere to all diagnostic procedures and precautions. Failure to do so may result in personal injury or damage to the test equipment.
- To avoid damaging the test equipment or generating false data, make sure the vehicle battery is fully charged and the connection to the vehicle DLC is clean and secure.
- Do not place the test equipment on the distributor of the vehicle. Strong electro-magnetic interference can damage the equipment.

# CONTENTS

<b>1 USING THIS MANUAL .....</b>	<b>1</b>
1.1    CONVENTIONS .....	1
<b>2 GENERAL INTRODUCTION .....</b>	<b>3</b>
2.1    MAXICOM MK808Z-BT TABLET.....	3
2.2    MAXIVCI MINI.....	7
2.3    OTHER ACCESSORIES.....	9
<b>3 GETTING STARTED.....</b>	<b>10</b>
3.1    POWERING UP .....	10
3.2    POWERING DOWN .....	14
<b>4 DIAGNOSTICS.....</b>	<b>15</b>
4.1    ESTABLISHING VEHICLE COMMUNICATION.....	15
4.2    GETTING STARTED .....	17
4.3    VEHICLE IDENTIFICATION.....	19
4.4    NAVIGATION.....	23
4.5    DIAGNOSTIC FUNCTION ENTRANCE .....	26
4.6    DIAGNOSTIC FUNCTIONS .....	28
4.7    GENERIC OBDII OPERATIONS .....	41
4.8    DIAGNOSTICS REPORT.....	44
4.9    EXITING DIAGNOSTICS .....	47
<b>5 SERVICE.....</b>	<b>49</b>
5.1    OIL RESET SERVICE .....	49
5.2    ELECTRIC PARKING BRAKE (EPB) SERVICE.....	49
5.3    TIRE PRESSURE MONITORING SYSTEM (TPMS) SERVICE .....	50
5.4    BATTERY MANAGEMENT SYSTEM (BMS) SERVICE .....	50
5.5    STEERING ANGLE SENSOR (SAS) SERVICE .....	51
5.6    DIESEL PARTICLE FILTER (DPF) SERVICE .....	51
<b>6 DATA MANAGER .....</b>	<b>53</b>
6.1    VEHICLE HISTORY .....	54
6.2    WORKSHOP INFORMATION.....	56
6.3    CUSTOMER.....	57
6.4    IMAGE .....	58

6.5	CLOUD REPORT .....	59
6.6	PDF FILES .....	59
6.7	REVIEW DATA .....	60
6.8	DATA LOGGING .....	60
6.9	UNINSTALL APPS .....	60
<b>7</b>	<b>SETTINGS .....</b>	<b>61</b>
7.1	UNIT .....	61
7.2	LANGUAGE .....	61
7.3	PRINTING SETTINGS .....	62
7.4	REPORT SETTINGS .....	63
7.5	PUSH NOTIFICATIONS .....	63
7.6	AUTO UPDATE .....	64
7.7	VEHICLE LIST .....	64
7.8	SYSTEM SETTINGS .....	65
7.9	ABOUT .....	65
<b>8</b>	<b>UPDATE .....</b>	<b>66</b>
<b>9</b>	<b>VCI MANAGER .....</b>	<b>67</b>
9.1	VCI BLUETOOTH PAIRING .....	68
9.2	BAS BLUETOOTH PAIRING .....	68
9.3	VCI UPDATE .....	69
9.4	BAS UPDATE .....	70
<b>10</b>	<b>BATTERY TEST .....</b>	<b>71</b>
10.1	MAXIBAS BT506 BATTERY TESTER .....	72
10.2	POWER SOURCES .....	73
10.3	TEST PREPARATION .....	74
10.4	IN-VEHICLE TEST .....	76
10.5	OUT-OF-VEHICLE TEST .....	81
<b>11</b>	<b>MAXVIEWER .....</b>	<b>84</b>
<b>12</b>	<b>SUPPORT .....</b>	<b>86</b>
12.1	SUPPORT SCREEN LAYOUT .....	86
12.2	MY ACCOUNT .....	86
12.3	DATA LOGGING .....	87
12.4	TRAINING .....	87

12.5	FAQ.....	87
<b>13</b>	<b>REMOTE DESKTOP.....</b>	<b>88</b>
<b>14</b>	<b>MAXIVIDEO .....</b>	<b>90</b>
<b>15</b>	<b>QUICK LINK .....</b>	<b>91</b>
<b>16</b>	<b>AUTEL USER CENTER .....</b>	<b>92</b>
<b>17</b>	<b>MAINTENANCE AND SERVICE.....</b>	<b>94</b>
17.1	MAINTENANCE INSTRUCTIONS.....	94
17.2	TROUBLESHOOTING CHECKLIST .....	95
17.3	ABOUT BATTERY USAGE .....	95
17.4	SERVICE PROCEDURES.....	96
<b>18</b>	<b>COMPLIANCE INFORMATION .....</b>	<b>99</b>
<b>19</b>	<b>WARRANTY .....</b>	<b>101</b>

# 1 Using This Manual

This manual contains device usage instructions.

Some illustrations shown in this manual may make reference to modules and optional equipment that are not included in your system. Contact your sales representative for availability of other modules and optional tools or accessories.

## 1.1 Conventions

---

The following conventions are used:

### 1.1.1 Bold Text

Bold text is used to highlight selectable items such as buttons and menu options.

Example:

- Tap **OK**.

### 1.1.2 Notes and Important Messages

#### 1.1.2.1 *Notes*

A **NOTE** provides helpful information such as additional explanations, tips, and comments.

#### 1.1.2.2 *Important*

**IMPORTANT** indicates a situation which, if not avoided, may result in damage to the test equipment or vehicle.

### 1.1.3 Hyperlinks

Hyperlinks are available in electronic documents. Blue italic text indicates a selectable hyperlink; blue underlined text indicates a website link or an email address link.



## 1.1.4 Illustrations

Illustrations used in this manual are samples; the actual testing screen may vary for each vehicle being tested. Observe the menu titles and on-screen instructions to make correct option selection.

## 1.1.5 Procedures

An arrow icon indicates a procedure.

Example:

### ➤ **To power down the tablet**

1. Long press the **Power/Lock** button.
2. Tap **Power Off**. The tablet will turn off in a few seconds.

# 2 General Introduction

Featuring the powerful quad-core processor, and a 7.0-inch LCD capacitive touchscreen, based on the Android multitasking operating system, and combined with the ability to quickly read and clear DTCs for all available modules of the majority of the makes and models on the market, the MaxiCOM MK808Z-BT is your ideal auto diagnostics and service tool, providing you with superior functions, including Oil Reset, EPB (Electronic Parking Brake), SAS (Steering Angle Sensor), BMS (Battery Management System), and DPF (Diesel Particulate Filter).

There are two main components of the MK808Z-BT system:

- MK808Z-BT Tablet — the central processor and monitor for the system.
- MaxiVCI Mini — a vehicle communication interface. Used for accessing vehicle data.

This manual describes the construction and operation of both devices and how they work together to deliver diagnostic solutions.

## 2.1 MaxiCOM MK808Z-BT Tablet

---

### 2.1.1 Function Description

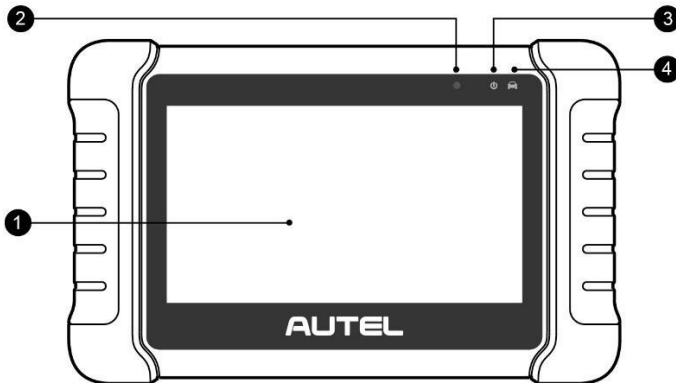

**Figure 2-1 Tablet Front View**

1. 7.0" LCD Touchscreen
2. Ambient Light Sensor — detects ambient brightness.
3. Power LED — indicates battery level & charging or system status.
4. Vehicle Communication LED — flashes green when the tablet is communicating with the vehicle's system.

The power LED displays green, yellow, or red depending on power level and operating state.

A. Green

- Illuminates green when the tablet is charging and the battery level is above 90%.
- Illuminates green when the tablet is powered on and the battery level is above 15%.

B. Yellow

- Illuminates yellow when the tablet is charging and the battery level is below 90%.

C. Red

- Illuminates red when the tablet is powered on and the battery level is below 15%.
- Illuminates red when the tablet shows abnormality after being powered on or during charging.

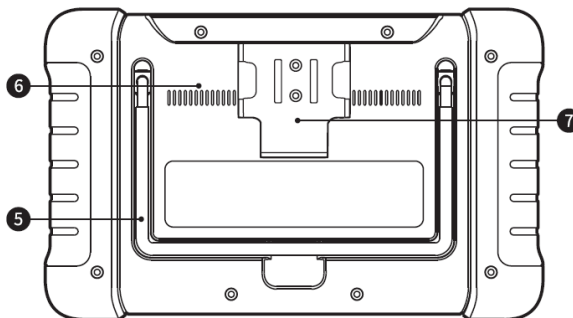

**Figure 2-2 Tablet Back View**

5. Collapsible Stand — extends from the back to allow hands-free viewing of the tablet.
6. Heat Sink
7. MaxiVCI Mini Holder

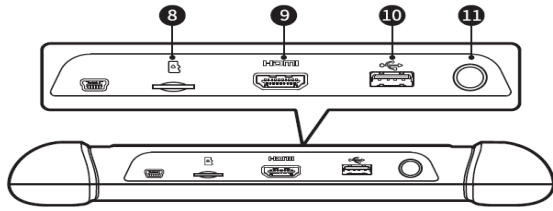

**Figure 2-3 Tablet Top View**

8. Micro SD Card Slot — holds the Micro SD card.
9. HDMI (High-Definition Multimedia Interface) Port
10. USB Port
11. Power/Lock Button — turns the device on/off with long press, or locks the screen with short press.

## 2.1.2 Power Sources

The tablet can receive power from any of the following sources:

- Internal Battery Pack
- External Power Supply

### 2.1.2.1 Internal Battery Pack

The tablet can be powered with the internal rechargeable battery, which if fully charged can provide sufficient power for about 6.5 hours of continuous operation.

### 2.1.2.2 External Power Supply

The tablet can be powered from a wall socket using the included Mini USB cable and the external power adapter. The external power supply also charges the internal battery pack.

## 2.1.3 Technical Specifications

**Table 2-1 Specifications**

Item	Description
<b>Recommended Use</b>	Indoor
<b>Operating System</b>	Android™ 11
<b>Processor</b>	Quad-core processor (1.8 GHz)
<b>Memory</b>	4 GB RAM & 64 GB ROM
<b>Display</b>	7-inch LCD screen with 1024 x 600 resolution
<b>Connectivity</b>	<ul style="list-style-type: none"> <li>● Mini USB 2.0</li> <li>● USB 2.0</li> <li>● Wi-Fi</li> <li>● Bluetooth</li> <li>● HDMI Type A</li> <li>● Mini SD card (supports up to 64 GB)</li> </ul>
<b>Sensor</b>	Ambient light sensor for brightness auto changing
<b>Audio Input/Output</b>	<ul style="list-style-type: none"> <li>● Input: N/A</li> <li>● Output: buzzer</li> </ul>
<b>Power and Battery</b>	<ul style="list-style-type: none"> <li>● 3.7 V/5000 mAh lithium-polymer battery</li> <li>● Charges via 5 V DC power supply</li> </ul>
<b>Tested Battery Life</b>	Around 6.5 hours of continuous use
<b>Battery Charging Input</b>	5 V/2 A
<b>Power Consumption</b>	Approx. 600 mA (LCD on with default brightness, Wi-Fi on) @3.7 V
<b>Operating Temp.</b>	0 to 50 °C (32 to 122 °F)
<b>Storage Temp.</b>	-10 to 60 °C (14 to 140 °F)
<b>Operating Humidity</b>	5% to 95% non-condensing
<b>Dimensions (W x H x D)</b>	270.8 mm (10.0") x 176.0 mm (6.9") x 36.0 mm (1.4")

Item	Description
Net Weight	885 g (2.31 lbs.)
Protocols	ISO9141-2, ISO14230-2, ISO15765, K/L-Line, Flashing Code, SAE-J1850 VPW, SAE-J1850PWM, ISO11898 (High-speed, Middle-speed, Low-speed and Single-wire CAN, fault-tolerant CAN), SAE J2610, GM UART, UART Echo Byte Protocol, Honda Diag-H Protocol, TP2.0, TP1.6

## 2.2 MaxiVCI Mini

MaxiVCI Mini is a vehicle communication interface (VCI) that connects to the tablet and vehicle's data link connector (DLC) for vehicle data transmission.

### 2.2.1 Function Description

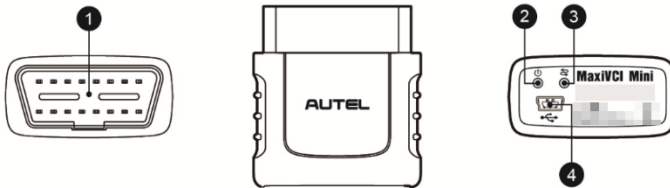

**Figure 2-4 MaxiVCI Mini Views**

1. Vehicle Data Connector (16-Pin) — connects the MaxiVCI Mini to the vehicle's 16-pin DLC directly.
2. Power LED — refers to [Table 2-2 Power LED](#) for details.
3. Connection LED — refers to [Table 2-3 Connection LED](#) for details.
4. Mini USB Port — provides the easiest connection between the device and the tablet via a Mini USB cable.

**Table 2-2 Power LED**

LED	Color	Description
Power	Green	Lights solid green when powered on.
	Red	Flashes red when a system failure occurs. <i>Note: The power LED briefly lights red each time the device powers on and then lights green when the device is ready.</i>

**Table 2-3 Connection LED**

LED	Color	Description
Connection	Green	<ul style="list-style-type: none"><li>• Lights solid green when the device is successfully connected via the Mini USB cable but is not communicating with the vehicle.</li><li>• Flashes green when the device is successfully connected via the Mini USB cable and is communicating with the vehicle.</li></ul>
	Blue	<ul style="list-style-type: none"><li>• Lights solid blue when the device is successfully connected via Bluetooth but is not communicating with the vehicle.</li><li>• Flashes blue when the device is successfully connected via Bluetooth and is communicating with the vehicle.</li></ul>

## 2.2.2 Power Source

The MaxiVCI Mini operates on 12-volt vehicle power, which is received through the vehicle's DLC. The unit powers on whenever it is connected to the vehicle's DLC.



## 2.2.3 Technical Specifications

Table 2-4 Specifications

Item	Description
Communications	<ul style="list-style-type: none"><li>• BT V.2.1 + EDR</li><li>• Mini USB 2.0</li></ul>
Wireless Frequency	2.4 GHz
Input Voltage Range	12 V DC to 24 V DC
Supply Current	150 mA @ 12 V DC
Operating Temp.	0 to 50 °C (32 to 122 °F)
Storage Temp.	-10 to 60 °C (14 to 140 °F)
Dimensions (L x W x H)	47 mm (1.7") x 23 mm (0.9") x 51 mm (2.0")
Weight	33.1 g (0.07 lbs.)

## 2.3 Other Accessories

---

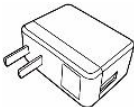
	<b>Mini USB Cable (for testing)</b> 2 m
	<b>Mini USB Cable (for charging)</b> 90 cm
	<b>External Power Adapter</b> Together with the Mini USB cable, connects the tablet to the external DC power port for power supply.



# 3 Getting Started

Ensure the tablet is sufficiently charged or is connected to an external power supply (see [Power Sources](#)).

**NOTE**

The images and illustrations depicted in this manual may differ slightly from those in the most recent product.

## 3.1 Powering Up

Long press the **Power/Lock** button on the top-right side of the tablet to power on the unit. The power LED will illuminate green. The system boots up and displays the lock screen. Slide the screen up to enter the MaxiCOM Job Menu.

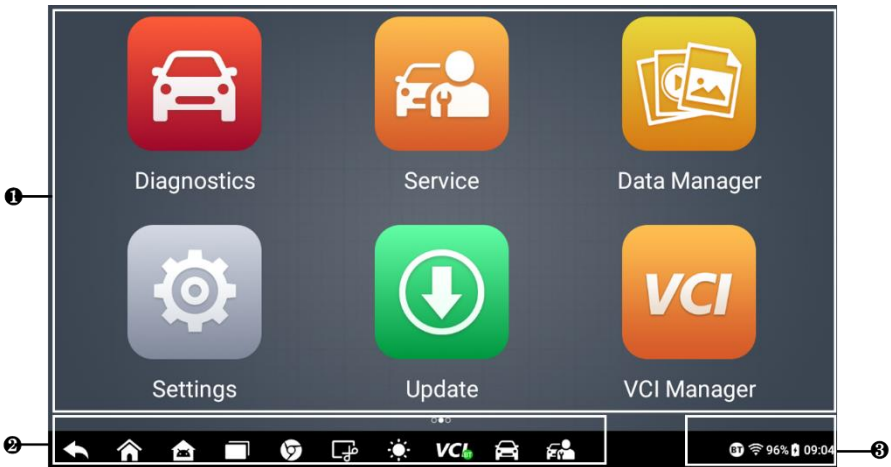

**Figure 3-1 MaxiCOM Job Menu**

1. Application Buttons
2. Locator and Navigation Buttons
3. System Status Icons

 **NOTE**







The tablet screen is locked by default when first powered on. We recommend you lock the screen to protect the information in the system and conserve the power.









The touchscreen navigation is menu-driven, enabling quick access to functions and features by tapping on the buttons on the screen. Detailed descriptions of the menu items are found in the application chapters.

### 3.1.1 Application Buttons

Descriptions of the tool applications are displayed in the table below:

**Table 3-1 Applications**











Button	Name	Description
	<b>Diagnostics</b>	Accesses diagnostic functions menu. See <a href="#">Diagnostics</a> for details.
	<b>Service</b>	Accesses special functions menu. See <a href="#">Service</a> for details.
	<b>Data Manager</b>	Accesses the organization system for saved data files. See <a href="#">Data Manager</a> for details.
	<b>Settings</b>	Accesses the MaxiCOM system settings menu and general tablet menu. See <a href="#">Settings</a> for details.
	<b>Update</b>	Checks for the latest update available for the MaxiCOM system and installs new software. See <a href="#">Update</a> for details.
	<b>VCI Manager</b>	Pairs the tablet and the MaxiVCI Mini. Checks the communication status and updates the VCI firmware. See <a href="#">VCI Manager</a> for details.
	<b>Battery Test</b>	Accesses the Battery Test menu with two functions, including In-vehicle test and Out-of-vehicle Test. See <a href="#">Battery Test</a> for details.

Button	Name	Description
	<b>MaxiViewer</b>	Provides quick search for the supported functions and vehicles of Autel diagnostic tools. See <a href="#">MaxiViewer</a> for details.
	<b>Support</b>	Launches the Support platform which synchronizes Autel's on-line service base station with the MaxiCOM tablet. See <a href="#">Support</a> for details.
	<b>Remote Desktop</b>	Configures the unit to receive remote support using the TeamViewer application. See <a href="#">Remote Desktop</a> for details.
	<b>MaxiVideo</b>	Configures the unit to operate as a video scope device by connecting to an imager head cable for close vehicle inspections. See <a href="#">MaxiVideo</a> for details.
	<b>Quick Link</b>	Provides associated website bookmarks to allow quick access to product update, service, support, and other information. See <a href="#">Quick Link</a> for details.
	<b>Autel User Center</b>	Allows users to register Autel tool for downloading the latest released software. See <a href="#">Autel User Center</a> for details.
	<b>MaxiTools</b>	Includes log collection and factory data reset two parts.
	<b>OEM Authorization</b>	Manages the permissions for unlocking the OE gateway.

### 3.1.2 Locator and Navigation Buttons

Operations of the navigation buttons at the bottom of the screen are described in the table below:

**Table 3-2 Locator and Navigation Buttons**

Button	Name	Description
	<b>Locator</b>	Indicates which screen you are on. Swipe the screen left or right to view the previous or next screen.
	<b>Back</b>	Returns to the previous screen.
	<b>MaxiCOM Home</b>	Returns to the MaxiCOM Job Menu from other operations.
	<b>Android Home</b>	Returns to the Android system's Home screen.
	<b>Recent Apps</b>	Displays a list of applications that are currently in use. Tap an app icon to launch. Close a running application by swiping it to the top, or close all running applications by tapping <b>Clear All</b> .
	<b>Chrome</b>	Launches the Google Chrome browser.
	<b>Screenshot</b>	Takes a screenshot when you want to save the displayed information.
	<b>Display Brightness</b>	Supports the display brightness automatically or manually adjustment.
	<b>VCI Manager Shortcut</b>	Opens the VCI Manager application. The BT or the cable badge at the bottom-right corner indicates the tablet is communicating with the VCI device. An "X" badge will display at the bottom-right corner if the tablet is not connected to the VCI device.
	<b>Diagnostics Shortcut</b>	Returns to the Diagnostics screen.
	<b>Service Shortcut</b>	Returns to the Service screen.

### 3.1.3 System Status Icons

By tapping the bottom-right corner or sliding from the top of the screen, a Shortcut Panel will be displayed, on which you are allowed to adjust various system settings for the tablet. As the tablet is working with Android operating system, you may refer to Android documents for more information.

## 3.2 Powering Down

---

All vehicle communications must be terminated before shutting down the tablet. A warning message appears if you attempt to shut down the tablet while it is communicating with the vehicle. Forcing a shut-down while communicating may lead to ECU problems on some vehicles. Please exit the Diagnostics application before powering down.

➤ **To power down the tablet**

1. Long press the **Power/Lock** button.
2. Tap **Power Off**. The tablet will turn off in a few seconds.

### 3.2.1 Reboot System

In case of a system crash, long press the **Power/Lock** button and tap the **Restart** option to restart the system.

# 4 Diagnostics

The Diagnostics application can retrieve ECU information, read & erase DTCs, and view live data. The Diagnostics application can access the electronic control unit (ECU) for various vehicle control systems, including engine, transmission, antilock brake system (ABS), and airbag system (SRS).

## 4.1 Establishing Vehicle Communication

---

Prior to performing the Diagnostics function, ensure the tablet is connected to the test vehicle through the MaxiVCI Mini. To establish a proper vehicle communication between the tablet and the test vehicle, you can perform the following steps:

1. Connect the MaxiVCI Mini to the vehicle's DLC for both communication and power supply.
2. Connect the MaxiVCI Mini to the tablet via Bluetooth pairing or Mini USB cable connection.
3. A BT badge or an USB cable badge will display at the bottom-right corner of the VCI Manager shortcut, which means the communication of MaxiVCI Mini and MK808Z-BT tablet has been established, and the tablet is ready to start vehicle diagnosis.

### 4.1.1 Vehicle Connection

To connect the MaxiVCI Mini to the test vehicle, insert the vehicle data connector on the MaxiVCI Mini into the vehicle's DLC which is usually located under the vehicle dashboard, and the MaxiVCI Mini will be automatically powered on.

---

#### NOTE

The vehicle's DLC is not always located under the dashboard. Refer to the vehicle's user manual for DLC location.

---

### 4.1.2 VCI Connection

The Power LED on the MaxiVCI Mini will light solid green when properly connected to the vehicle and be ready to establish communication with the tablet.

The wireless diagnostic interface MaxiVCI Mini supports two communication methods with the tablet: Bluetooth or Mini USB Cable Connection.

#### 4.1.2.1 Bluetooth Connection

Bluetooth pairing is recommended as the first choice for the communication between the tablet and the MaxiVCI Mini. This is because the Bluetooth connection does not need to repeat the plugging and unplugging procedure which is unavoidable when using traditional wired connection, saving more time and providing higher efficiency. The working range for Bluetooth communication is about 33 feet (about 10 m), enabling remote vehicle diagnostics.

Refer to [VCI Bluetooth Pairing](#) for details.

#### 4.1.2.2 Mini USB Cable Connection

Use the provided Mini USB cable to connect the tablet to the MaxiVCI Mini. An USB cable badge will display at the bottom-right corner of the VCI Manager shortcut and the Connection LED on MaxiVCI Mini will light solid green when the connection between the devices is successful.

### 4.1.3 No Communication Message

- A. If the tablet is not connected to the MaxiVCI Mini correctly, an “Error” message may display. This indicates that the tablet cannot access the vehicle control module. In this case, please do the following check-ups:
- Check if the MaxiVCI Mini is powered up.
  - Check if the MaxiVCI Mini is properly positioned.
  - Check if the Connection LED on the MaxiVCI Mini is illuminated for Bluetooth or Mini USB cable connection.
  - In the case of Bluetooth connection, check if the network is configured correctly, or if the right MaxiVCI Mini has been paired up with the tablet.
    - ◇ During the diagnosis process, if the communication is suddenly interrupted due to the loss of signal, check if there is any object that causes signal interruption.
    - ◇ Try standing closer to the MaxiVCI Mini to obtain more stable signals and faster communication speed.
  - In the case of Mini USB cable connection, check the cable connection between the tablet and the MaxiVCI Mini.
  - Check if the Power LED on the MaxiVCI Mini is flashing red and if so, it indicates there is a hardware problem with the MaxiVCI Mini. In this case, contact technical support for help.
- B. If the MaxiVCI Mini is unable to establish a communication link, a prompt message

displays with check instructions. The following conditions are the possible causes:

- The MaxiVCI Mini is unable to establish a communication link with the vehicle.
- The system selected for testing is not equipped on the vehicle.
- There is a loose connection.
- There is a blown vehicle fuse.
- There is a wiring fault of the vehicle or the adapter.
- There is a circuit fault in the adapter.
- Incorrect vehicle identification was entered.

## 4.2 Getting Started

Ensure a communication link is established between the test vehicle and the tablet via the MaxiVCI Mini.

### 4.2.1 Vehicle Menu Layout

When the tablet is properly connected to the vehicle, the platform is ready to start vehicle diagnosis. Tap the **Diagnostics** application button on the MaxiCOM Job Menu to access the Vehicle Menu.



Figure 4-1 Vehicle Menu











1. Top Toolbar Buttons
2. Vehicle Manufacturer Buttons



### 4.2.1.1 Top Toolbar Buttons

The operations of the toolbar buttons at the top of the screen are listed and described in the table below:

**Table 4-1 Top Toolbar Buttons**

Button	Name	Description
	<b>Home</b>	Returns to the MaxiCOM Job Menu.
	<b>VID</b>	Provides a fast way to identify the test vehicle. See <a href="#">Vehicle Identification</a> for details.
	<b>All</b>	Displays all the vehicle manufacturers.
	<b>Favorites</b>	Adds your preferred vehicle manufacturers into favorites.
	<b>History</b>	Displays the saved history records. See <a href="#">Vehicle History</a> for details.
	<b>America</b>	Displays vehicles from American manufacturers.
	<b>Europe</b>	Displays vehicles from European manufacturers.
	<b>Asia</b>	Displays vehicles from Asian manufacturers.
	<b>China</b>	Displays vehicles from Chinese manufacturers.
	<b>Search</b>	Tap the search field to show a virtual keyboard and enter a vehicle manufacturer name.
	<b>Cancel</b>	Tap to exit the search screen or cancel an operation.

### 4.2.1.2 Vehicle Manufacturer Buttons

The vehicle manufacturer buttons list the vehicle brands available for testing. Select the manufacturer button after the tablet is properly connected to the test vehicle to start a diagnostics session.

## 4.3 Vehicle Identification

The MaxiCOM diagnostics system supports four methods for vehicle identification:

1. Auto Detect
2. Manual Input
3. Automatic Selection
4. Manual Selection

### 4.3.1 Auto Detect

The MaxiCOM diagnostics system features the latest VIN-based Auto Detect function to identify vehicles and scan all the diagnosable ECUs and run diagnostics on the selected system. This function is compatible with 2006 and newer vehicles.

#### ➤ To perform Auto Detect

1. Tap the **Diagnostics** application button from the MaxiCOM Job Menu. The Vehicle Menu displays.
2. Tap the **VID** button on the top toolbar to open the dropdown list.



Figure 4-2 VID Screen

3. Select **Auto Detect**. Once the test vehicle is identified, the screen will display the vehicle VIN. Tap **OK** at the bottom-right corner to confirm the vehicle VIN. If the VIN does not match with the test vehicle's VIN, enter VIN manually or tap **Read** to acquire VIN again.



**Figure 4-3 Auto Detect Screen**

4. Tap **Yes** to confirm the vehicle profile, or tap **No** if the information is incorrect.



**Figure 4-4 Vehicle Profile Screen**

5. The tool establishes communication with the vehicle and reads the control unit information. Choose **Auto Scan** to scan all the test vehicles' available systems or tap **Control Unit** to access a specific system to diagnose.

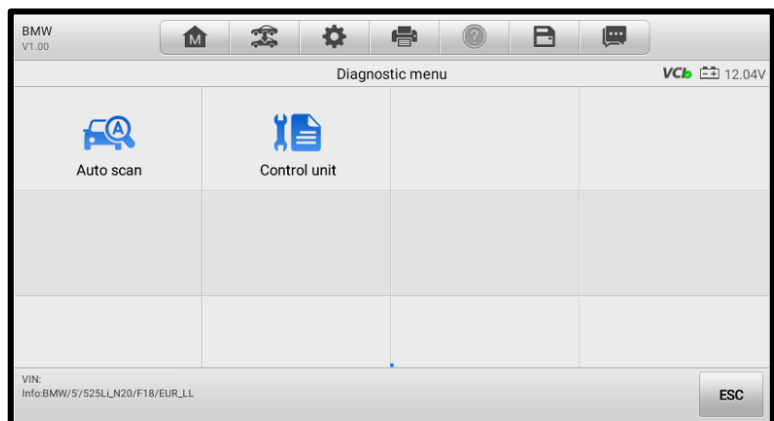

**Figure 4-5 Diagnostic Menu Screen**

## 4.3.2 Manual Input

For vehicles not supporting the Auto Detect function, you may manually enter the VIN.

### ➤ To perform Manual Input

1. Tap the **Diagnostics** application button from the MaxiCOM Job Menu. The Vehicle Menu displays.
2. Tap the **VID** button on the top toolbar to open the dropdown list.
3. Select **Manual Input**.
4. Enter the correct VIN into the input box.

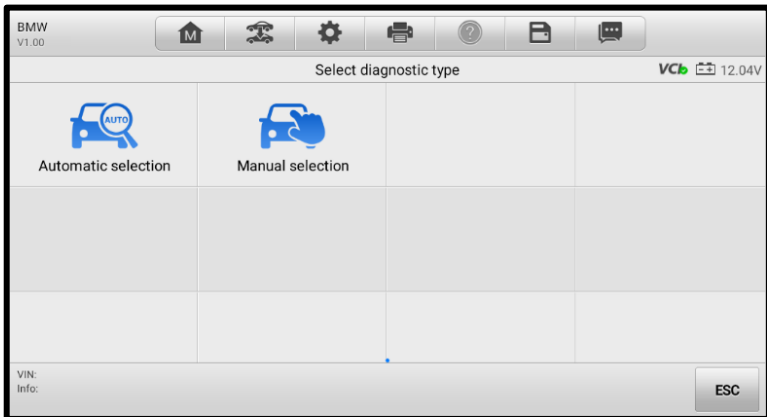

**Figure 4-6 Manual Input Screen**

5. Tap **OK**. Once the vehicle is identified, the Vehicle Diagnostics screen displays.
6. Tap **✕** at the top-right of the dialog box to exit Manual Input.

### 4.3.3 Automatic Selection

The vehicle VIN can also be automatically acquired after a vehicle manufacturer is selected.



**Figure 4-7 Selection Screen**

➤ **To perform Automatic Selection**

1. Tap the **Diagnostics** application button from the MaxiCOM Job Menu. The Vehicle Menu displays.
2. Select a vehicle manufacturer.
3. Tap **Automatic Selection** and the VIN information will be acquired automatically. Follow the on-screen instruction to display the Diagnostic Menu screen.

### 4.3.4 Manual Selection

When the VIN is not automatically retrievable through the vehicle's ECU, or when the VIN is unknown, you can select the vehicle manually.

This mode of vehicle selection is menu-driven. Repeat the first two steps from the automatic selection operation and tap **Manual Selection**. Through a series of on-screen prompts and selections, the test vehicle is chosen. If needed, tap the **ESC** button at the bottom-right corner of the screen to return to the previous screen.

## 4.4 Navigation

---

After the test vehicle is identified, the Diagnostic Menu screen will appear. This section consists of various commonly used functions, including Auto Scan and Control Unit. The available functions displayed vary depending on the test vehicle.

### 4.4.1 Diagnostic Screen Layout

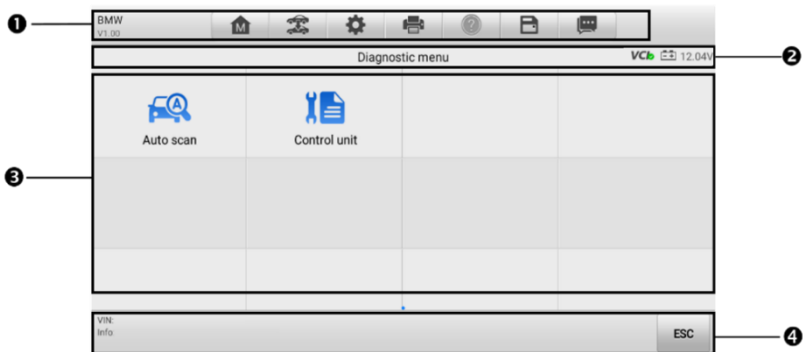

Figure 4-8 *Diagnostic Menu Screen*







The Diagnostic Menu screen typically includes four sections:

1. Diagnostics Toolbar
2. Status Information Bar
3. Main Section
4. Function Buttons

#### 4.4.1.1 Diagnostics Toolbar

The Diagnostics Toolbar contains several buttons such as print and save. The table below provides a brief description for the operations of these buttons:

**Table 4-2 Diagnostics Toolbar Buttons**

Button	Name	Description
	<b>Home</b>	Returns to the MaxiCOM Job Menu.
	<b>Vehicle Swap</b>	Exits the service session of the currently identified test vehicle and returns to the Vehicle Menu screen.
	<b>Settings</b>	Opens the settings screen. See <a href="#">Settings</a> for details.
	<b>Print</b>	Prints a copy of the displayed data. See <a href="#">Printing Settings</a> for details.
	<b>Help</b>	Displays instructions for operations.
	<b>Save</b>	Opens a submenu which provides options for data storage.
	<b>Data Logging</b>	Records the communication data and ECU information of the test vehicle. When encountering an error during testing and diagnosing, use this function to contact Autel's technical staff for solutions. See <a href="#">Data Logging</a> for details.

#### ➤ To print data in Diagnostics

1. Tap the **Diagnostics** application button from the MaxiCOM Job Menu. The **Print** button on the Diagnostic Toolbar is available throughout the whole Diagnostics operations.

2. Tap **Print**. A drop-down menu will be displayed:
  - Print This Page — prints a screenshot of the current screen.
  - Print All Data — prints a PDF file of all displayed data.
3. A temporary file will be created and sent to the connected PC for printing.
4. When the file is transferred successfully, a confirmation message will appear.

➤ **To submit Data Logging reports in Diagnostics**

1. Tap the **Diagnostics** application button from the MaxiCOM Job Menu. The **Data Logging** button on the Diagnostic Toolbar is available throughout the whole Diagnostics operations.
2. Tap the **Data Logging** button to display the error options. Select a specific error, and a submission form will appear to let you fill in the report information.
3. Tap the **Send** button in the upper-right corner of the screen to submit the report form via the Internet. A confirmation message will appear when sent successfully.

#### 4.4.1.2 *Status Information Bar*

The Status Information Bar at the top of the Main Section may display the following items:

1. Menu Title — displays the menu heading of the Main Section.
2. VCI Icon — displays the VCI connection status.
3. Voltage Icon — displays the vehicle's voltage status.

#### 4.4.1.3 *Main Section*

The Main Section of the screen varies according to the stage of operations, which may display vehicle identification selections, the main menu, test data, messages, instructions, and other diagnostic information.

#### 4.4.1.4 *Function Buttons*

The displayed Function Buttons vary depending on the stage of operations. These buttons can be used to navigate menus, to save or clear diagnostic data, to exit scanning, and to perform a number of other control functions. The use of these buttons will be discussed in detail in the following sections of the corresponding test operations.

## 4.4.2 **Screen Messages**

Screen messages will appear when additional input is needed before proceeding. There are three main types of on-screen messages: Confirmation, Warning, and Error.



#### 4.4.2.1 *Confirmation Messages*

Confirmation messages inform you when you about to perform an action that cannot be reversed or when an action has been initiated and confirmation is needed to continue.

When a user-response is not required to continue, the message displays briefly.

#### 4.4.2.2 *Warning Messages*

This type of messages displays a warning that a selected action may result in an irreversible change or loss of data. An example of this type of message is the “Erase Codes” message.

#### 4.4.2.3 *Error Messages*

Error messages display when a system or procedural error has occurred. Examples of possible errors include cable disconnection or communication interruption.

### 4.4.3 **Making Selections**

The Diagnostics application is a menu-driven program that presents a series of choices. As a selection is made, the next menu in the series displays. Each selection narrows the focus and leads to the desired test. Tap the screen to make menu selections.

## 4.5 **Diagnostic Function Entrance**

---

The Diagnostics application enables a data link to the electronic control system of the test vehicle for vehicle diagnosis. The application performs function tests, retrieves vehicle diagnostic information such as trouble and event codes, and live data from various vehicle control systems such as engine, transmission, and ABS.

There are two options available when accessing the Diagnosis section:

1. Auto Scan — starts auto scanning for all the available systems on the vehicle.
2. Control Unit — displays a selection menu for all available control units of the test vehicle.

After a selection is made and the tablet establishes communication with the vehicle, the corresponding function menu or selection menu will display.

### 4.5.1 **Auto Scan**

The Auto Scan function performs a comprehensive scanning over all the ECUs in the vehicle to locate systems faults and retrieve DTCs. An example of Auto Scan interface is pictured as below:

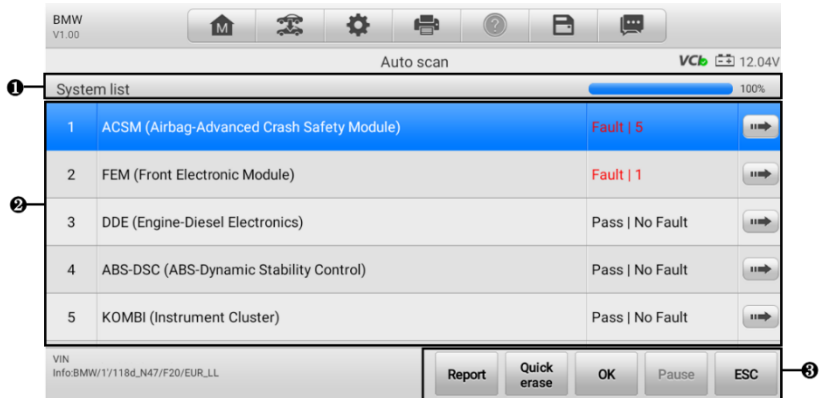

**Figure 4-9 Auto Scan Screen**

1. Navigation Bar
2. Main Section
3. Function Buttons

#### 4.5.1.1 Navigation Bar

List Tab — displays the scanned data in list format.

Progress Bar — indicates the test progress.

#### 4.5.1.2 Main Section

Column 1 — displays the sequence numbers.

Column 2 — displays the scanned systems.

Column 3 — displays the diagnostic indicators describing test results:

These indicators are defined as follows:

- ❖ **Fault(s) | #:** Fault(s) indicate(s) there is/are detected fault code(s) present; “#” indicates the number of the detected faults.
- ❖ **Pass | No Fault:** Indicates the system has passed the scanning process and no fault has been detected.

Column 4 — tap to enter the related system to view the detailed information and perform further diagnosis or testing.

#### 4.5.1.3 Function Buttons

The table below provides a brief description of the Function Buttons:

**Table 4-3 Function Buttons in Auto Scan**

Name	Description
<b>Report</b>	Displays the diagnostic data in a report form.
<b>Quick erase</b>	Deletes codes. A warning message screen will display to inform you of possible data loss when this function is selected.
<b>OK</b>	Confirms the test result. Continues the system diagnosis after a required system is selected by tapping the item in the Main Section.
<b>Pause</b>	Suspends scanning and it will change to the <b>Continue</b> button after tapping.
<b>ESC</b>	Returns to the previous screen or exits Auto Scan.

## 4.5.2 Control Unit

The Control Unit function allows you to manually locate a required control system for testing through a series of choices. Follow the menu-driven procedures and make proper selections; the program will guide you to the proper diagnostic function menu based on selections.

## 4.6 Diagnostic Functions

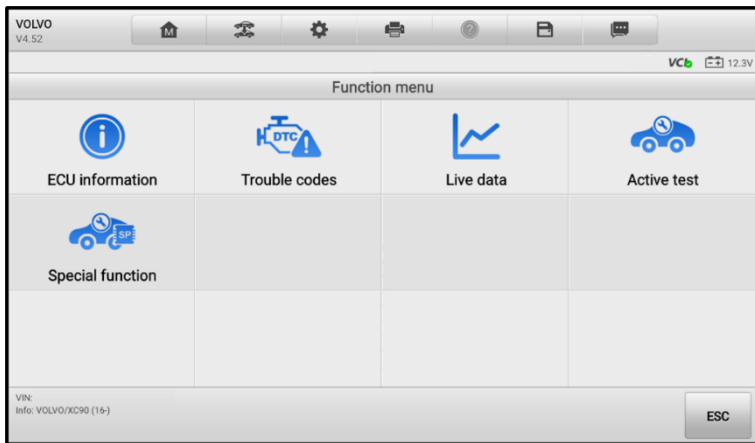

**Figure 4-10 Function Menu Screen**

The Diagnostic Functions are listed on the Function Menu screen. The Function Menu options vary slightly for different vehicles, which may include:

- ECU Information — provides the retrieved ECU information in detail. An information screen opens upon selection.
- Trouble Codes — contains Read Codes and Erase Codes. The former displays detailed DTC information retrieved from the vehicle control module, the latter allows you to erase DTCs and other data from the ECU.
- Live Data — retrieves and displays live data and parameters from the vehicle's ECU.
- Active Test — accesses vehicle-specific subsystem and components tests.
- Special Function — performs various component adaptations.

### NOTE

The Diagnostics Toolbar functions such as saving and printing of test results can be performed throughout the whole diagnostic testing. Data logging and help information are also available.

#### ➤ To perform a diagnostic function

1. Establish communication with the test vehicle.
2. Identify the test vehicle by selecting from the menu options.
3. Locate the required system for testing by **Auto Scan** or through menu-driven selections in **Control Unit**.
4. Select the desired diagnostic function from the Function Menu.

## 4.6.1 ECU Information

This function retrieves and displays the specific information for the tested control unit, including unit type, version numbers, and other specifications.

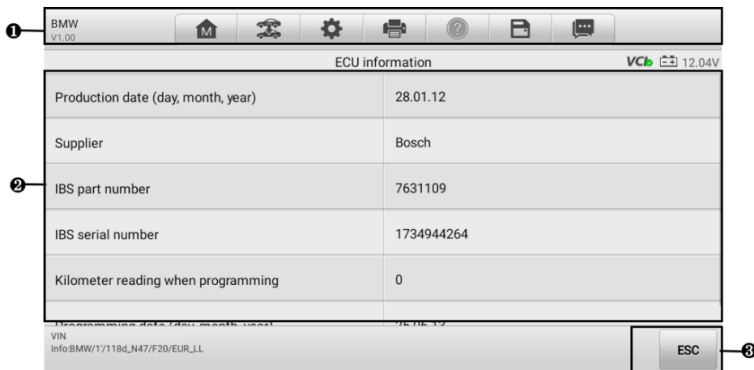

Figure 4-11 ECU Information Screen

1. Diagnostics Toolbar Buttons — see [Table 4-2 Diagnostics Toolbar Buttons](#) for detailed descriptions of the operations for each button.
2. Main Section — the left column displays the item names; the right column shows the specifications or descriptions.
3. Function Button — in this case, only the **ESC** button is available. Tap it to exit after viewing.

## 4.6.2 Trouble Codes

### a) Read Codes

This function retrieves and displays the DTCs from the vehicle's control system. The Read Codes screen varies for each vehicle being tested. On some vehicles, freeze frame data can also be retrieved for viewing.

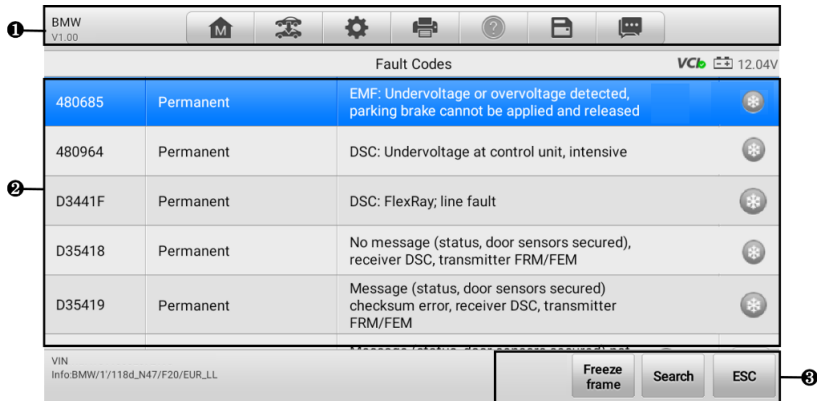

**Figure 4-12 Read Codes Screen**

1. Diagnostics Toolbar Buttons — see [Table 4-2 Diagnostics Toolbar Buttons](#) for detailed descriptions of the operations for each button.
2. Main Section
  - Column 1 — displays the retrieved codes from the vehicle.
  - Column 2 — indicates the status of the retrieved codes.
  - Column 3 — detailed descriptions for the retrieved codes.
  - Snowflake Icon — only displays when freeze frame data is available for viewing; selecting this icon will display a data screen, which looks and behaves similar to the Read Codes screen.
3. Function Button
  - Freeze Frame — tap to view the freeze frame.

- Search — tap to search for related fault code information on the Internet.
- ESC — tap to return to the previous screen or exit the function.

#### b) Erase Codes

After reading the retrieved codes and making appropriate vehicle repairs, use this function to erase vehicle codes.

#### ➤ To erase codes

1. Tap **Erase Codes** from the Trouble Codes screen.
2. A warning message displays to inform you of data clearing when this function is applied.
  - ◇ Tap **Yes** to continue. A Confirmation screen displays when the operation is successfully done.
  - ◇ Tap **No** to exit.
3. Tap **ESC** on the Confirmation screen to exit Erase Codes.
4. Perform the Read Codes function again to check if the codes have been erased successfully.

### 4.6.3 Live Data

When this function is selected, the screen displays the data list for the selected module. The items available for any control module vary by vehicle. The parameters display in the order that they are transmitted by the ECU, so expect variation among vehicles.

Gesture scrolling allows you to quickly move through the data list. Touch the screen and drag your finger up or down to reposition the parameters being displayed if the data occupies more than one screen. The figure below displays a typical Live Data screen:

Name	Value	Range	Unit
<input type="checkbox"/> \$7E8 Long term secondary O2 sensor fuel trim - bank2 (use if only 1 fuel trim value)	0	-100...99.2 2	%
<input type="checkbox"/> \$7E8 Fuel rail pressure(absolute)	680	0...655350	kPa
<input type="checkbox"/> \$7E8 Relative accelerator pedal position	50.2	0...40	%
<input type="checkbox"/> \$7E8 Hybrid battery pack remaining charge	50.2	0...100	%
<input type="checkbox"/> \$7E8 Engine oil temperature	88	-20...150	°C
<input type="checkbox"/> \$7E8 Fuel injection timing	46	-210.00...3	°

Toolbar buttons: Cancel All, Show selected, Graph merge, To top, Setting, Clear data, Freeze, Record, Review, Back

**Figure 4-13 Live Data Screen**

1. Diagnostics Toolbar Buttons — tap the drop-down button at the top center of the screen and the toolbar buttons will display. See [Table 4-2 Diagnostics Toolbar Buttons](#) for detailed descriptions of the operations for each button.
2. Main Section
  - Name Column — displays the parameter names.
    - a) Check Box — tap the check box on the left side of the parameter name to make item selection. Tap the check box again to deselect the item.
    - b) Drop-down Button — tap the drop-down button on the right side of the parameter name to open a sub menu, providing data display mode options.
  - Value Column — displays the values of the parameters.
  - Range Column — displays the ranges of the parameters.
  - Unit Column — displays the unit for the parameters (Tap the **Settings** button on the top toolbar and select a required mode. See [Unit](#) for more information).
3. Function Buttons — There are many function buttons on the Live Data screen. Detailed descriptions of these buttons are described in the following subsections.

#### A. Display Mode

There are four types of display modes available for data viewing, allowing you to view various types of parameters in the mode best suited to represent the data.

Tap the drop-down button on the right side of a parameter name to open a submenu. A total of 7 buttons will be displayed: The 4 buttons to the left represent different data display modes, plus one Information button (active when additional information is available), one Unit Change button (for switching the unit of displayed data), and one Trigger button (tap to open the Trigger Settings screen).

Name	Value	Range	Unit
<input type="checkbox"/> Absolute throttle position	16.1	0...100	%
<div style="display: flex; justify-content: space-around; border: 1px solid gray; padding: 2px;"> <span></span> <span><b>A</b></span> <span></span> <span></span> <span></span> <span></span> <span></span> </div>			
<input type="checkbox"/> Location of oxygen sensors	B1S12-B2S--	--	
<input type="checkbox"/> Oxygen sensor output voltage bank 1-sensor 1	0.455	0...1.275	V
<input type="checkbox"/> Short term fuel trim bank 1-sensor 1	0	-100...99.2 2	%
<input type="checkbox"/> Oxygen sensor output voltage bank 1-sensor 2	0.455	0...1.275	V

**Figure 4-14 Display Mode Screen**

Each parameter item displays the selected mode independently.

- ◆ Analog Gauge Mode — displays the parameters in gauge charts.
- ◆ Text Mode — the default mode that displays the parameters as a text list.

---

**NOTE**

Status parameters, such as a switch reading like ON, OFF, ACTIVE, and ABORT, can only be displayed in Text Mode. Value parameters, such as a sensor reading, can be displayed in both text and graph modes.

---

- ◆ Waveform Graph Mode — displays the parameters in waveform graphs. In this mode, five control buttons will display on the right side of the parameter item, allowing you to manipulate the display status.



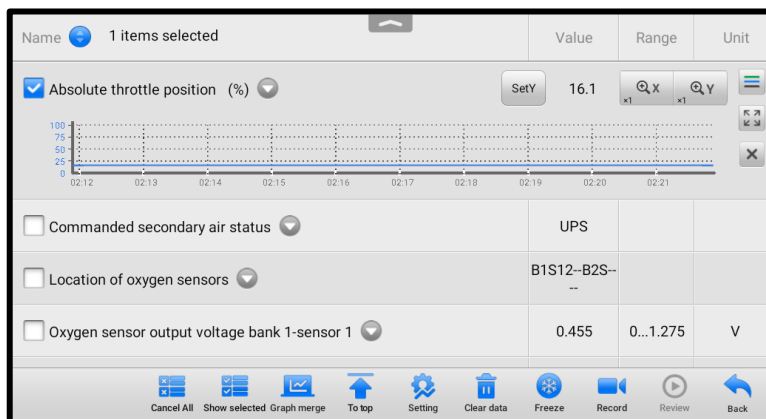

**Figure 4-15 Waveform Graph Mode Screen**

- Settings Button (SetY)** — sets the minimum and maximum value of the Y axis.
- Scale Button** — changes the scale values.

There are two scale buttons displayed above the waveform graph, which can be used to change the scale values of the X axis and Y axis of the graph. There are four scales available for the X axis: x1, x2, x4 and x8. And there are three scales available for the Y axis: x1, x2, and x4.

- Edit Button** — edits the waveform color and line thickness.
- Zoom-in Button** — tap once to display the selected data graph in full screen.
- Exit Button** — tap to exit the waveform graph mode.

**Full Screen Display** — this option is only available in the waveform graph mode, and mostly used in Graph Merge status for data comparison. There are four control buttons available on the top right side of the screen under this mode.

- **Scale Button** — tap to change the scale values below the waveform graph. There are four scales available for the X axis: x1, x2, x4 and x8. And there are three scales available for the Y axis: x1, x2, and x4.
- **Edit Button** — tap to open an edit window, in which you can set the waveform color and line thickness displayed for the selected parameter.
- **Zoom-out Button** — tap to exit full screen display.
- **Exit Button** — tap to exit the waveform graph mode.

➤ **To edit the waveform color and line thickness in a data graph**

1. Select a parameter to display in Waveform Graph mode.

2. Tap the **Edit** button, and an edit window displays.

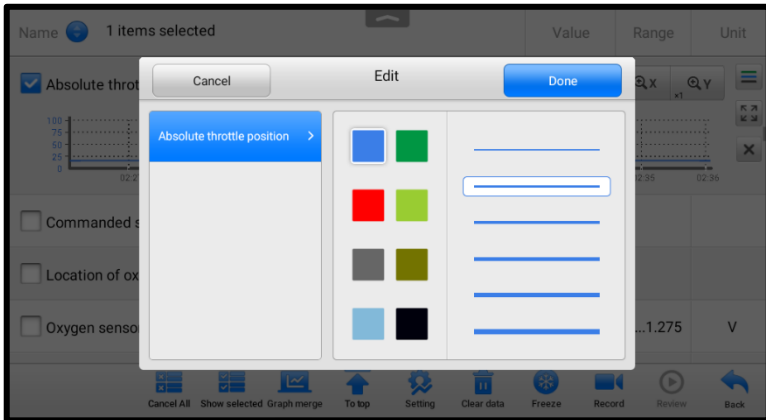

**Figure 4-16 Waveform Edit Screen**

3. The parameter is selected automatically in the left column.
  4. Select a color from the middle column.
  5. Select a line thickness from the right column.
  6. Tap **Done** to save the setting and exit, or tap **Cancel** to exit without saving.
- ◆ Digital Gauge Mode — displays the parameters in the form of a digital gauge graph.

## **B. Trigger Settings**

On the Trigger Settings screen, you can set a standard range by filling in a minimum value and a maximum value. When exceeding this range, the trigger function will be executed and the device will automatically record and save the generated data. You can review the saved live data by tapping the **Review** button at the bottom of the screen.

Tap the drop-down button on the right side of a parameter name to open a submenu. The Trigger button is the last one in the submenu. Tap to display the Trigger Settings screen.

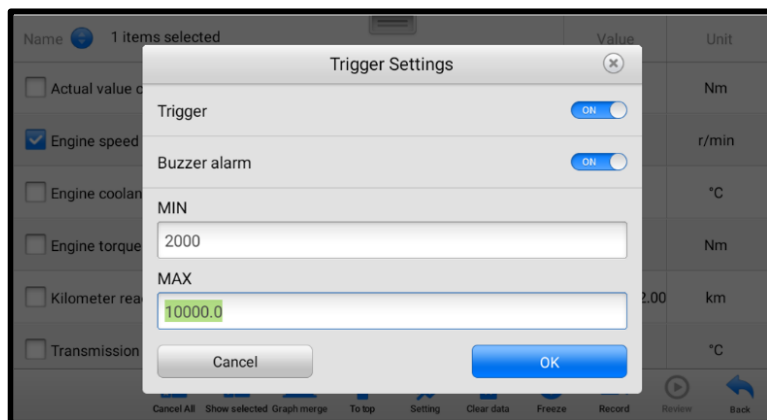

**Figure 4-17 Trigger Settings Screen**

Two buttons and two input boxes are available in the Trigger Settings screen.

- a) **Trigger** — switches the trigger on or off. The trigger is ON by default.
- b) **Buzzer Alarm** — switches the alarm on or off. The alarm function makes a beeping sound as an alert when the data reading reaches the preset minimum or maximum point. The buzzer alarm will only sound at the first trigger.
- c) **MIN** — tap this input box to enter the required lower limit value.
- d) **MAX** — tap this input box to enter the required upper limit value.

➤ **To set a trigger**

1. Tap the drop-down button on the right side of a parameter name to open a submenu.
2. Tap the **Trigger** button on the right side of the submenu to open the Trigger Settings screen.
3. Tap the MIN value input box to enter the required minimum value.
4. Tap the MAX value input box to enter the required maximum value.
5. Tap **OK** to save the settings and return to the Live Data screen, or tap **Cancel** to exit without saving.

When the trigger is successfully set, a trigger mark displays in front of the parameter name. The mark is gray when it is not triggered, and displays orange when triggered. Moreover, two horizontal lines display on each of the data graphs (when Waveform Graph Mode is applied) to indicate the alarm point. The limit lines are shown in different colors to differentiate them from the parameter waveforms.

### C. Function Buttons

The operations of the available Function Buttons on the Live Data screen are described below:

**Cancel All** — tap this button to cancel all selected parameters. Up to 50 parameters can be selected at one time.

**Show Selected/Show All** — tap this button to switch between the two options: one displays the selected parameters, the other displays all the available items.

**Graph Merge** — tap this button to merge selected data graphs (for Waveform Graph Mode only). This function is very useful when comparing different parameters.

---

#### NOTE

This mode supports graph merge of 2 to 5 parameters that can be represented digitally. Non-digital parameters are not supported.

---

#### ➤ **To merge selected data graphs**

1. Select parameters that need to be merged.
2. Tap the **Graph Merge** button at the bottom of the Live Data screen.
  - a) This mode only supports parameters that can be represented digitally. If non-digital parameters are selected, a message will display advising the user that the selected parameters are not supported in this mode and to select 2 to 5 digital parameters. Tap **Got It** to return to the previous screen and select supported parameters.
  - b) When unsupported parameters are selected, a message will appear advising the user to select only supported parameters. A message will also display if more than 5 parameters have been selected. Please select 2 to 5 of the supported parameters and tap the **OK** button to merge.
3. Tap the **Cancel Merging** button at the bottom of the Live Data screen to cancel merging.

**To top** — moves a selected item to the top of the list.

**Setting** — tap this button to set recording duration.

#### ➤ **To set live data record duration**

1. Tap the **Setting** button at the bottom of the Live Data screen.
2. Tap the “>” button to the right of **Recording Time After Trigger** bar and select a time length.
3. Tap **OK** to save the setting and return to the Live Data Setting screen; or tap the “X” button at the upper-right corner to exit without saving.
4. Tap **Done** at the upper-right corner of the Live Data Setting screen to confirm

and save the setting, and return to the Live Data screen, or tap **Cancel** to exit without saving.

**Clear Data** — tap this button to clear all cached live data.

**Freeze** — displays the retrieved data in freeze mode.

- Previous Frame — moves to the previous frame of frozen data.
- Next Frame — moves to the next frame of frozen data.
- Play/Pause — tap to play/pause the frozen data.
- Resume — tap to exit the freeze data mode and return to normal data display.

**Record** — starts recording the live data of the selected data items. Tap the **Record** button at the bottom of the Live Data screen. A message will display prompting the user to select parameters to record. Tap the **Got It** button to confirm. Scroll down and select data to record. Tap the **Record** button to start recording. Tap the **Resume** button to stop recording. The recorded live data can be viewed in the **Review** section at the bottom of the Live Data screen. The recorded data can also be reviewed in the Data Manager application.

- Resume — tap this button to stop data recording and return to normal data display.
- Flag — this button displays when the Record function is applied. Tap this button to set flags when recording data. Notes can be added during playback in Review or Data Manager. Select the preset flag to open a pop-up window and display a virtual keyboard to enter notes.

**Review** — review the recorded data. Tap the **Review** button to display a recording list, and select one item to review.

---

 **NOTE**

Only the data recorded during the current operation can be reviewed on the Live Data screen. All the historical recorded data can be reviewed in Review Data in the Data Manager application.

---

- Previous Frame — switches to the previous frame of recorded data.
- Next Frame — switches to the next frame of recorded data.
- Play/Pause — tap to play/pause the recorded data.
- Show Selected — displays the selected parameters.
- Graph Merge — merges selected data graphs.
- Back — exits the review and returns to the Live Data screen.

**Back** — returns to the previous screen or exits the function.

## 4.6.4 Active Test

The Active Test function is used to access vehicle-specific subsystem and component tests. Available tests vary by vehicle.

During an active test, the tablet sends commands to the ECU to activate the actuators. This test determines the integrity of the system or part by reading ECU data, or by monitoring the operation of the actuators. Such tests may include switching a solenoid, relay or switch, between two operating states.

Selecting Active Test displays a menu of test options. Available tests vary by vehicle. Select a test from the menu options, and follow the instructions displayed on the screen to complete the test. Procedures and instructions vary by vehicle.

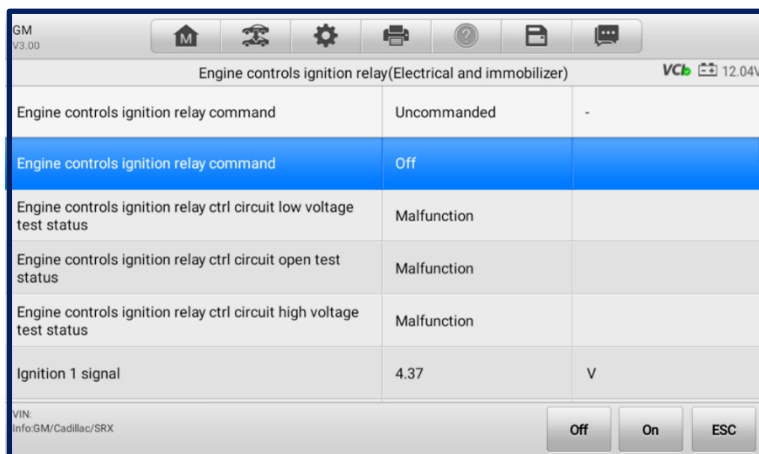
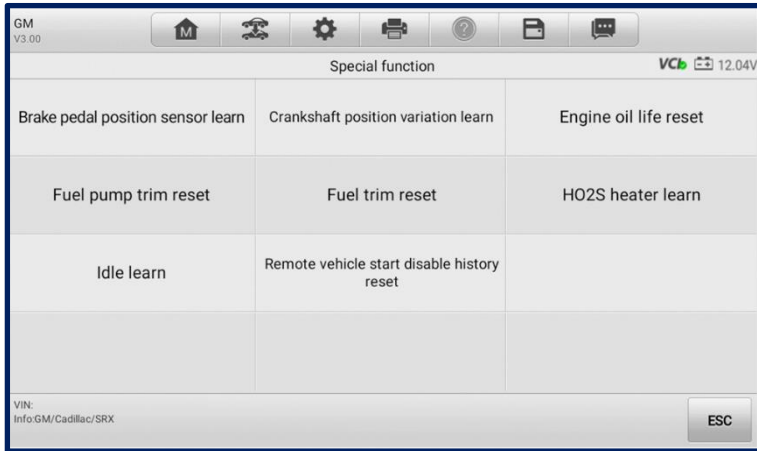

**Figure 4-18 Active Test Screen**

The function buttons in the lower-right corner of the Active Test screen manipulate the test signals. Operational instructions are displayed in the main section of the test screen. Follow the on-screen instructions and make appropriate selections to complete the tests. Tap the **ESC** button to exit the test when finished.

## 4.6.5 Special Functions

These functions perform various component adaptations, including the recalibration or configuration of certain components after repairs or replacements have been completed.



**Figure 4-19 Special Function Screen 1**

Select a function to display detailed information and the execution screen.



**Figure 4-20 Special Function Screen 2**

List Tab Page:

- Column 1 — displays the description of the function being performed or the live data corresponding to the special function.
- Column 2 — displays the execution status such as Completed or Activated or the corresponding live data values.
- Column 3 — displays the measurement units of the live data.

Tap a function button to perform the selected function or exit the function.

## 4.7 Generic OBDII Operations

---

This option presents a quick way to check for DTCs, isolate the cause of an illuminated malfunction indicator lamp (MIL), check monitor status prior to emissions certification testing, and perform a number of other services that are emissions-related. The OBD direct access option is also used for testing OBDII/EOBD compliant vehicles that are not included in the database.

The diagnostics toolbar buttons at the top of the screen function the same as those available for specific vehicle diagnostics. See [Table 4-2 Diagnostics Toolbar Buttons](#) for details.

### 4.7.1 General Procedure

➤ **To access the OBDII/EOBD diagnostics functions**

1. Tap the **Diagnostics** application button from the MaxiCOM Job Menu. The Vehicle Menu displays.
2. Tap the **EOBD** button. There are two options to establish communication with the vehicle:
  - Auto Scan — when this option is selected, the diagnostic tool attempts to establish communication using each protocol in order to determine which one the vehicle is using.
  - Protocol — when this option is selected, the screen opens a submenu listing various protocols. A communications protocol is a standardized way of data communication between an ECU and a diagnostic tool. Global OBD may use several different communication protocols.
3. Select a specific protocol under the **Protocol** option. Wait for the OBDII Diagnostic Menu to display.



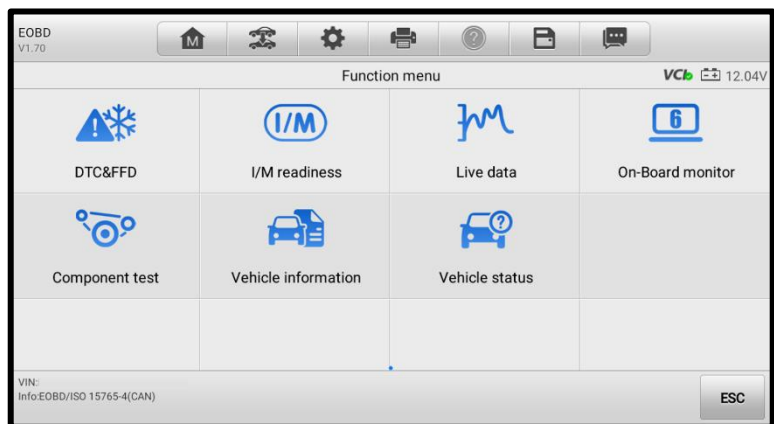

**Figure 4-21 OBDII Diagnostic Menu**

4. Select a function to continue.
  - **DTC & FFD**
  - **I/M Readiness**
  - **Live Data**
  - **On-Board Monitor**
  - **Component Test**
  - **Vehicle Information**
  - **Vehicle Status**

**NOTE**

The supported functions may vary by vehicles.

## 4.7.2 Function Descriptions

This section describes the various functions of each diagnostic option:

### 4.7.2.1 DTC & FFD

When this function is selected, the screen displays a list of stored and pending codes. A snowflake icon will display on the right side of the DTC item when the freeze frame data is available for viewing.

- **Current Codes**

Current codes are the current emissions-related DTCs from the ECU of the vehicle. OBDII/EOBD codes have a priority according to their emission severity, with higher

priority codes overwriting lower priority codes. The priority of the code determines the illumination of the MIL and the codes erase procedure. Manufacturers rank codes differently, so DTCs may vary by vehicle.

- **Pending Codes**

These are codes that were generated during the last drive cycle, but before the DTC actually sets, two or more consecutive drive cycles are needed. The intended use of this service is to assist the service technician after a vehicle repair and after clearing diagnostic information, by reporting test results after a single driving cycle.

- a) If a test failed during the drive cycle, the DTC associated with that test is reported. If the pending fault does not occur again within 40 to 80 warm-up cycles, the fault is automatically cleared from memory.
- b) Test results reported do not necessarily indicate a faulty component or system. If test results indicate another failure after additional driving, a DTC is stored to indicate a faulty component or system.

- **Freeze Frame**

Typically, the stored freeze frame is the last DTC reported. Certain DTCs that have a greater impact on vehicle emission, have a higher priority. In these cases, the top prioritized DTC is the one for which the freeze frame records are retained. Freeze frame data includes a “snapshot” of critical parameter values at the time the DTC is set.

- **Erase Codes**

This option is used to clear all emissions-related diagnostics data including DTCs, freeze frame data, and specific manufacturer-enhanced data from the vehicle ECU. This option resets the I/M Readiness Monitor Status for all vehicle monitors to “Not Ready” or “Not Complete”.

A Confirmation screen will appear when the Clear Codes option is selected to prevent accidental loss of data. Select **Yes** on the confirmation screen to continue, or select **No** to exit.

#### 4.7.2.2 *I/M Readiness*

This function is used to check the readiness of the monitoring system. It is an excellent function to use prior to having a vehicle inspected for state emissions compliance. Select I/M readiness to display a sub menu with two choices:

- **Since DTCs Cleared** — displays the status of monitors since the last time the DTCs are erased.
- **This Driving Cycle** — displays the status of monitors since the beginning of the current drive cycle.

### 4.7.2.3 *Live Data*

This function displays the real time PID data from ECU. Displayed data includes analog inputs and outputs, digital inputs and outputs, and system status information broadcast on the vehicle data stream.

Live data can be displayed in various modes. See [Live Data](#) for detailed information.

### 4.7.2.4 *On-Board Monitor*

Use this option to view the results of on-board monitor tests. The tests are useful after servicing or after erasing a vehicle's control module memory.

### 4.7.2.5 *Component Test*

This function enables dual-directional control of the ECU so that the diagnostic tool is able to transmit control commands to operate the vehicle systems. This function is useful in determining how well the ECU responds to a command.

### 4.7.2.6 *Vehicle Information*

The option displays the vehicle identification number (VIN), the calibration identification, and the calibration verification number (CVN), and other information of the test vehicle.

### 4.7.2.7 *Vehicle Status*

This function checks the current condition of the vehicle, such as the communications protocols of OBDII modules, quantity of fault codes, and the status of the malfunction indicator light (MIL).

## 4.8 **Diagnostics Report**

---

### 4.8.1 **Diagnostics Report Saving, Viewing, and Sharing**

The diagnostic report can be reviewed, saved, and shared with others through many ways.

#### 4.8.1.1 *Diagnostics Report Saving*

- Via the **History** function
  - 1) Enter the main screen of the Diagnostics application, and tap **History** on the top toolbar.

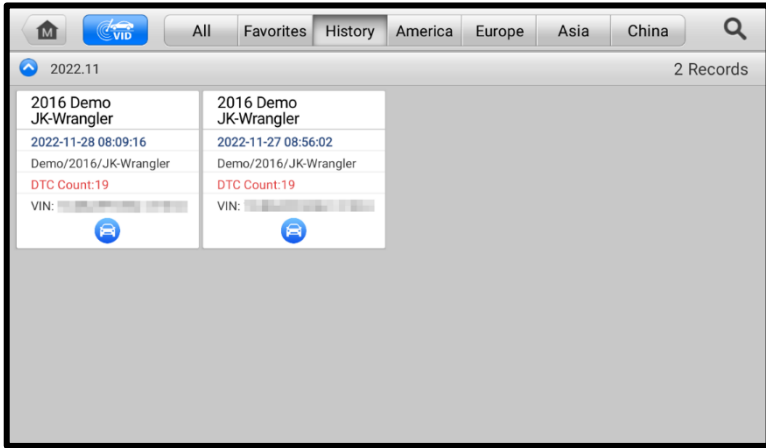

**Figure 4-22 History Screen**

- 2) Select a history record, and tap the **⋮** button on the upper-right corner.

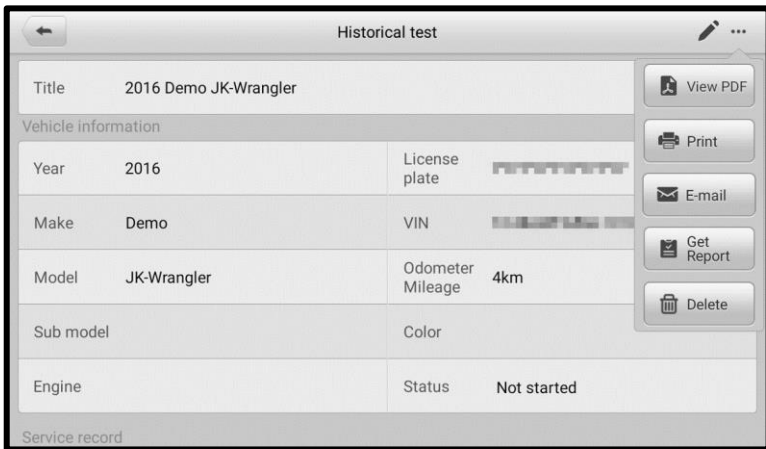

**Figure 4-23 Historical Test Screen**

- 3) Tap **Get Report**. Enter the license plate and current mileage. Tap **Save**.

- Via the functions on the Diagnostics Toolbar

The diagnostic report can also be viewed from such diagnostics functions screen including Auto scan and Trouble codes. There are two ways to view the saved reports:

- ✧ Tap the **📄** button in the diagnostics toolbar and select **Save as PDF**. Enter the license number and tap **Save**. Tap the **📄** button on the upper-right of the screen to view the report.

- ✧ Tap the  button in the diagnostics toolbar and select **Report to Cloud**. Enter the license plate and current mileage. Tap **Save > View Report** and then select a saved report to view.



**Figure 4-24 Trouble Codes Screen**

#### 4.8.1.2 Diagnostics Report Viewing

All the saved reports can be viewed in the Data Manager application.

- ✧ Tap **Data Manager > Vehicle History**. Select a specific vehicle history record and then tap **View PDF** in the upper-right corner to view the report.
- ✧ Once you saved the reports by tapping the **Save as PDF** button, tap **Data Manager > PDF** to view these reports.
- ✧ Once you saved the reports by tapping the **Get Report** or **Report to Cloud** button, tap **Data Manager > Cloud Report** to view these reports.

#### 4.8.1.3 Diagnostics Report Cloud Sharing

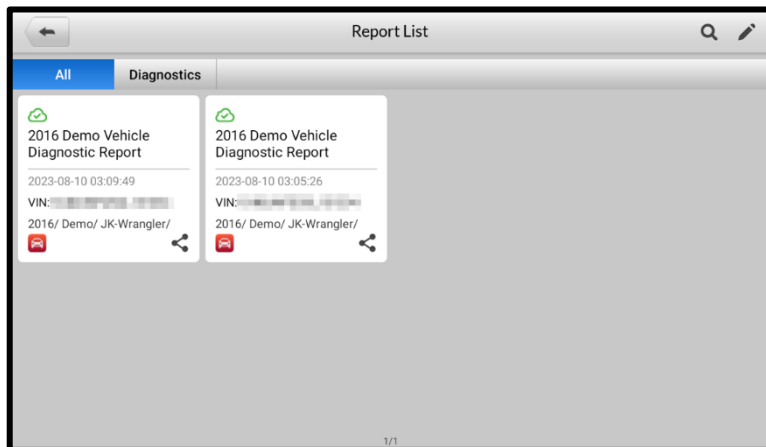

1. Tap **Data Manager > Cloud Report** to enter the Report List screen.



**Figure 4-25 Report List**

2. Tap the  on the lower-right corner of the report.

 **NOTE**

Note that if the report displays , it means the report has been uploaded to the cloud successfully, and you can share the report with others; if the report displays , it means the report has failed to upload to the cloud, but will try to automatically upload to the cloud when entering the Report again.

3. There are three ways for report cloud sharing: scan the QR code, send by email, or send by SMS (via phone number).

## 4.9 Exiting Diagnostics

The Diagnostics application remains open as long as there is an active communication with the vehicle. You must exit the diagnostics operation to stop all communications with the vehicle before closing the Diagnostics application.

 **NOTE**

Damage to the vehicle electronic control module (ECM) may occur if the communication is disrupted. Ensure all forms of communication link such as data cable, USB cable, and wireless or wired network, are properly connected throughout the test. Exit all interfaces before disconnecting the test cable and power supply.

 **To exit the Diagnostics application**

On an active diagnostic screen:

1. Tap the **Back** or **ESC** button to exit a diagnostic session step by step.
2. Or tap the **Vehicle Swap** button on the Diagnostics Toolbar to return to the

Vehicle Menu screen.

On the Vehicle Menu screen:

1. Tap the **Home** button on the top toolbar.
2. Or tap the **Back** button on the Navigation Bar at the bottom of the screen.
3. Or tap the **Home** button on the Diagnostics Toolbar to exit the application directly and return to the MaxiCOM Home Menu.

Now, the Diagnostics application is no longer communicating with the vehicle and it is safe to open other MaxiCOM applications.

# 5 Service

The Service application is specially designed to provide quick access to the vehicle systems for various scheduled service and maintenance tasks. The typical service operation screen is a series of menu-driven executive commands. Follow on-screen instructions to select appropriate execution options, enter correct values or data, and perform necessary actions. The application will display detailed instructions to complete selected service operations.

After entering a special function, the screen will display two options: Diagnosis and Hot Functions. The Diagnosis option enables the reading and clearing of codes which are sometimes necessary after completing certain special functions. The Hot Functions consists of sub functions of the selected special function.

The most commonly used services are described in this chapter.

## 5.1 Oil Reset Service

---

This function performs reset of the Engine Oil Life system, which calculates the optimal oil life change interval depending on the vehicle driving conditions and climate. The Oil Life Reminder must be reset each time the oil is changed, so the system can calculate when the next oil change is required.

### NOTE

1. Always reset the engine oil life to 100% after every oil change.
  2. All required work must be carried out before the service indicators are reset. Failure to do so may result in incorrect service values and cause DTCs to be stored by the relevant control module.
  3. For some vehicles, the tool can reset additional service lights such as the maintenance cycle and service interval. On BMW vehicles for example, service resets include engine oil, spark plugs, front/rear brakes, coolant, particle filter, brake fluid, micro filter, vehicle inspection, exhaust emissions inspection and vehicle checks.
- 

## 5.2 Electric Parking Brake (EPB) Service

---

This function has a multitude of usages to maintain the electronic braking system safely and effectively. The applications include deactivating and activating the brake control system, assisting with brake fluid control, opening and closing brake pads, and setting brakes after disc or pad replacement.



## 5.2.1 EPB Safety

It can be dangerous to perform Electric Parking Brake (EPB) system maintenance, so before you begin the service work, please keep these rules in mind:

- ✓ Ensure that you are fully familiar with the braking system and its operation before commencing any work.
- ✓ The EPB control system may be required to be deactivated before carrying out any maintenance/diagnostic work on the brake system. This can be done from the tool menu.
- ✓ Only perform maintenance work when the vehicle is stationary and on level ground.
- ✓ Ensure that the EPB control system is reactivated after the maintenance work has been completed.

---

### NOTE

Autel accepts no responsibility for any accident or injury arising from the maintenance of the Electric Parking Brake system.

---

## 5.3 Tire Pressure Monitoring System (TPMS) Service

---

This function allows you to quickly look up the tire sensor IDs from the vehicle's ECU, as well as to perform TPMS replacement and reset procedures after tire sensors are replaced.

## 5.4 Battery Management System (BMS) Service

---

The Battery Management System (BMS) allows the tool to evaluate the battery charge state, monitor the close-circuit current, register the battery replacement, activate the rest state of the vehicle, and charge the battery via the diagnostic socket.

---

### NOTE

1. This function is not supported by all vehicles.
  2. The sub functions and actual test screens of the BMS may vary by vehicle, please follow the on-screen instructions to make correct selections.
- 

The vehicle may use either a sealed lead-acid battery or an AGM (Absorbed Glass Mat) battery. Lead acid battery contains liquid sulphuric acid and can spill when overturned. AGM battery (known as VRLA battery, valve regulated lead acid) also contains sulphuric acid, but the acid is contained in glass mats between terminal plates.

It is recommended that the replacement aftermarket battery has the same specifications, such as capacity and type, as the exiting battery. If the original battery is replaced with a different type of battery (e.g. a lead-acid battery is replaced with an AGM battery) or a battery with a different capacity (mAh), the vehicle may require reprogramming of the

new battery type, in addition to, performing the battery reset. Consult the vehicle manual for additional vehicle-specific information.

## 5.5 Steering Angle Sensor (SAS) Service

---

Steering Angle Sensor Calibration permanently stores the current steering wheel position as the straight-ahead position in the steering angle sensor EEPROM. Therefore, the front wheels and the steering wheel must be set exactly to the straight-ahead position before calibration. In addition, the vehicle identification number (VIN) is also read from the instrument cluster and stored permanently in the steering angle sensor EEPROM. On successful completion of calibration, the steering angle sensor fault memory is automatically cleared.

Calibration must always be carried out after the following operations:

- Steering wheel replacement.
- Steering angle sensor replacement.
- Any maintenance that involves opening the connector hub from the steering angle sensor to the column.
- Any maintenance or repair work on the steering linkage, steering gear or other related mechanism.
- Wheel alignment or wheel track adjustment.
- Accident repairs where damage to the steering angle sensor, SAS assembly, or any part of the steering system may have occurred.



### NOTE

1. Autel accepts no responsibility for any accident or injury arising from servicing the SAS system. When interpreting DTCs retrieved from the vehicle, always follow the manufacturer's recommendation for repair.
  2. All software screens shown in this manual are examples, actual test screens may vary by test vehicle. Pay attention to the menu titles and onscreen instructions to make correct selections.
  3. Before starting any procedure, make sure vehicle has an ESC button. Look for button on dash.
- 

## 5.6 Diesel Particle Filter (DPF) Service

---

The Diesel Particle Filter (DPF) function manages DPF regeneration, DPF component replacement teach-in and DPF teach-in after replacing the engine control unit.

The ECM monitors driving style and selects a suitable time to employ regeneration. Cars driven a lot at idling speed and low load will attempt to regenerate earlier than cars

driven more with higher load and speed. In order for regeneration to take place, a prolonged high exhaust temperature must be obtained.

In the event of the car being driven in such a way that regeneration is not possible, i.e., frequent short journeys, a diagnostic trouble code will eventually be registered in addition to the DPF light and “Check Engine” indicators displaying. A service regeneration can be requested in the workshop using the diagnostic tool.

Before performing a forced DPF regeneration using the tool, check the following items:

- The fuel light is not on.
- No DPF-relevant faults are stored in system.
- The vehicle has the specified engine oil.
- The oil for diesel is not contaminated.

---

**!** **IMPORTANT**

Before diagnosing a problematic vehicle and attempting to perform an emergency regeneration, it is important to obtain a full diagnostic log and read out relevant measured value blocks.

---

**✎** **NOTE**

1. The DPF will not regenerate if the engine management light is on, or there is a faulty EGR valve.
  2. The ECU must be re-adapted when replacing the DPF and when topping up the fuel additive Eolys.
  3. If the vehicle needs to be driven in order to perform a DPF service, a second person is needed for the function. One person should drive the vehicle while the other person observes the screen on the Tool. Do not attempt to drive and observe the scan tool at the same time. This is dangerous and puts your life and the lives of other motorists and pedestrians at risk.
-

# 6 Data Manager



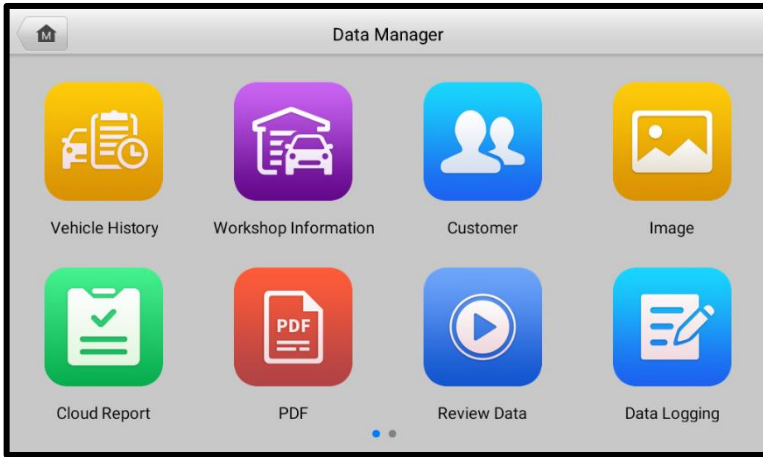

The Data Manager application allows you to store, print, and review the saved files, manage the workshop information, and customer information records, and keep test vehicle records.





Selecting the Data Manager application opens the file system menu. There are nine main functions available.



**Figure 6-1 Data Manager Main Screen**

**Table 6-1 Buttons in Data Manager**

Button	Name	Description
	<b>Vehicle History</b>	Tap to review the diagnostic history record.
	<b>Workshop Information</b>	Tap to edit the information of workshops.
	<b>Customer</b>	Tap to create a new customer account file.
	<b>Image</b>	Tap to review the screenshots.

Button	Name	Description
	<b>Cloud Report</b>	Tap to view the local reports on your tablet. If the report is successfully uploaded to cloud, you can also share the report with others.
	<b>PDF</b>	Tap to review the reports stored as PDF format.
	<b>Review Data</b>	Tap to review the recorded data.
	<b>Data Logging</b>	Tap to review the communication data and ECU information of the test vehicle. The saved data can be reported and sent to the technical center via the Internet.
	<b>Uninstalled Apps</b>	Tap to uninstall applications.

## 6.1 Vehicle History

---

This function stores records of test vehicle records, including vehicle information and the retrieved DTCs from previous diagnostic sessions. Test information is summarized and displayed in an easy-to-read table listing. The Vehicle History also provides direct access to the previously tested vehicle and allows you to directly restart a diagnostic session without needing to perform auto or manual vehicle selection.

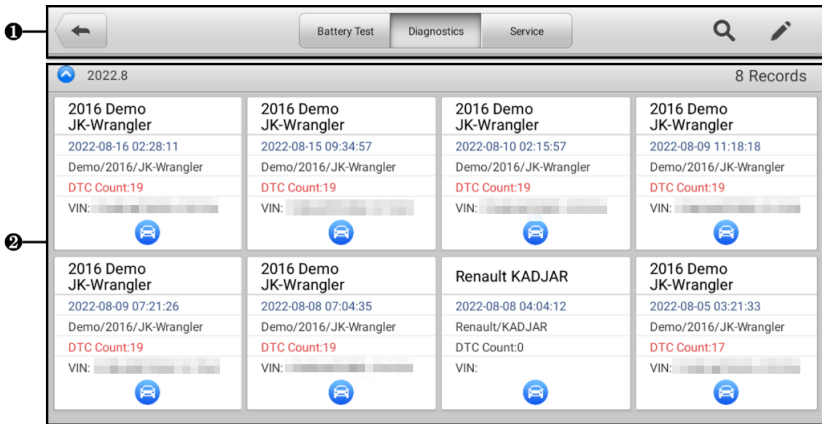

**Figure 6-2 Vehicle History Screen**

1. Top Toolbar Buttons — displays navigation and application controls.
  2. Main Section — displays all the vehicle history records.
- **To activate a test session for the recorded vehicle**
1. Tap the **Data Manager** application on the MaxiCOM Job Menu.
  2. Select **Vehicle History** to open the screen. Tap the relevant application tab to select the test record. Take selecting the **Diagnostics** tab as an example.
  3. Tap **Diagnostics** icon at the bottom of the thumbnail of a vehicle record item. The Diagnostics screen of the vehicle displays and a new diagnostic session is activated. See [Diagnostics](#) for detailed instructions on vehicle diagnostic operations.
  4. A Historical Test record sheet displays. Check the recorded information of the recorded test vehicle and tap the **Diagnostics** button on the upper-right corner.
  5. Select a vehicle thumbnail to choose a record. A Historical Test record sheet displays. Review the recorded information of the test vehicle, and tap the **Diagnostics** button on the upper-right corner to continue the diagnostics.

### 6.1.1 Historical Test Record

The Historical Test Record is a detailed data form of the vehicle, which includes general vehicle information, service record, customer information, and the diagnostic trouble codes retrieved from the previous test sessions. Technician Notes will also appear if present.

 **NOTE**

The MaxiCOM tablet must establish connection to the MaxiVCI Mini device to restart test sessions on the previously test vehicles.

Title		2016 Demo JK-Wrangler	
Vehicle information			
Year	2016	License plate	
Make	Demo	VIN	
Model	JK-Wrangler	Odometer Mileage	
Sub model		Color	
Engine		Status	Not started
Service record			
Technician			

**Figure 6-3 Historical Test Record Sheet**

➤ **To edit the Historical Test record**

1. Tap **Data Manager** on the MaxiCOM Job Menu.
2. Select **Vehicle History**.
3. Select the specific vehicle history record thumbnail from the main section. The Historical Test record will appear.
4. Tap **Edit** (the pen icon) to start editing.
5. Tap each item to input information or attach files or images.

**NOTE**

The vehicle VIN, license number, and customer account information are correlated by default. Vehicle records will automatically be correlated using this vehicle and customer identification.

6. Tap **Add to Customer** to supplement the Historical Test record sheet to an existing customer account, or add a new associated account with the test vehicle record. See [Customer](#) for more information.
7. Tap **Done** to save the updated record sheet, or tap **Cancel** to exit without saving.

## 6.2 Workshop Information

The Workshop Information form allows you to edit, input, and save the detailed workshop information, such as shop name, address, phone number, and other remarks, which, when printing vehicle diagnostic reports and other associated test file, will display as the header of the printed documents.

**Figure 6-4 Workshop Information Sheet**

➤ **To edit the Workshop Information sheet**

1. Tap the **Data Manager** application on the MaxiCOM Job Menu.
2. Select **Workshop Information**.
3. Tap the **Edit** button on the Top Toolbar.
4. Tap on each field to input the appropriate information.
5. Tap **Done** to save the updated workshop information sheet, or tap **Cancel** to exit without saving.

## 6.3 Customer

---

The Customer function allows you to create and edit customer accounts. It helps you to save and organize all customer information accounts that are correlated with the associated test vehicle history records.

➤ **To create a customer account**

1. Tap the **Data Manager** application on the MaxiCOM Job Menu.
2. Select **Customer**.
3. Tap the **Add a customer** button. An empty information form displays, tap each field to input the appropriate information.



**NOTE**

The items that must be filled are indicated as required fields.

---

4. Some customers may have more than one vehicle for service. You can always add new vehicle information to the account. Tap **Add New Vehicle Information**, and then fill in the vehicle information. Tap the ✕ button to cancel.



5. Tap **Complete** to save the account, or tap **Cancel** to exit without saving.

➤ **To edit a customer account**

1. Tap **Data Manager** on the MaxiCOM Job Menu.
2. Select **Customer**.
3. Select a customer account by tapping the corresponding name card. A Customer Information record displays.
4. Tap **Edit** on the Top Toolbar to start editing.
5. Tap on the input field to edit information, and enter the updated information.
6. Tap **Complete** to save the updated information, or tap **Cancel** to exit without saving.

➤ **To delete a customer account**

1. Tap **Data Manager** on the MaxiCOM Job Menu.
2. Select **Customer**.
3. Tap the **Delete** icon on the right of a customer account. A message displays.
4. Tap **OK** to confirm the command, and the account is deleted, or tap **Cancel** to cancel the request.

## 6.4 Image







The Image section is a PNG database containing all captured screenshots.



**Figure 6-5 Image Screen**

1. Top Toolbar Buttons — used to edit, print, and delete the stored image files. See the following table for detailed information.
2. Main Section — displays the stored images.

**Table 6-2 Toolbar Buttons in Image Screen**

Button	Name	Description
	<b>Back</b>	Returns to the previous screen.
	<b>Search</b>	Tap to search the image by entering its stored time.
	<b>Edit</b>	Tap to display the editing toolbar to select, delete, print, or email the image(s).
	<b>Cancel</b>	Tap to close the editing toolbar or cancel file search.
	<b>Print</b>	Tap to print the selected image.
	<b>Delete</b>	Tap to delete the selected image.
	<b>Email</b>	Tap to send the selected image to an email.

➤ **To edit/delete image(s)**

1. Select **Data Manager** from the MaxiCOM Job Menu.
2. Select **Image** to access the PNG database.
3. Tap **Edit** on the top-right corner of the screen. The editing screen displays.
4. Select the image(s) you want to edit by tapping the check box at the bottom-right corner of the image.
5. Tap the **Delete** icon to delete the selected images or delete all images. Tap **Print** to print the selected image(s). Tap **Email** to send the selected image(s) to an email.

## 6.5 Cloud Report

---

This section displays the saved reports, which can be transferred to the Autel cloud platform once a stable network connection is established. These reports can then be viewed or shared with others.

## 6.6 PDF Files

---

The PDF files designated for local viewing are displayed in this section. After entering the PDF database, select a PDF file to view the stored information.

This section uses the standard Adobe Reader application for file viewing and editing. Please refer to the associated Adobe Reader manual for more detailed instructions.

## 6.7 Review Data

---

The Review Data section allows you to play back the recorded data frames of live data streams.

On the Review Data main screen, select a record file to play back.

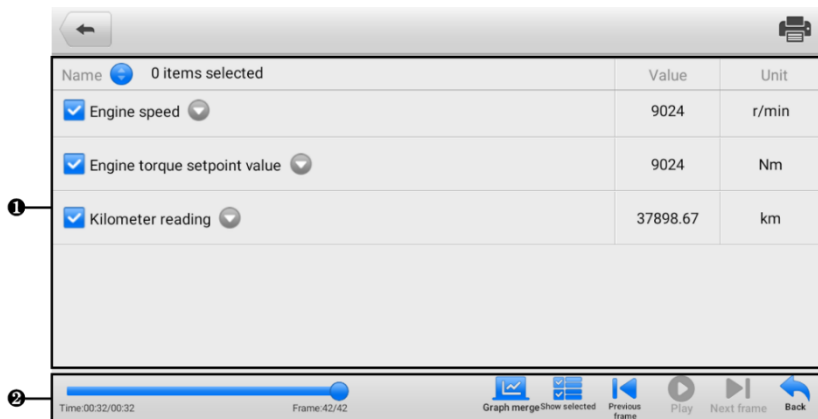

**Figure 6-6 Data Playback Screen**

1. Main Section — displays the recorded data frames.
2. Navigation Toolbar — allows you to manipulate data playback.

Use the Navigation Toolbar buttons to play back the recorded data from frame to frame.

Tap **Back** to exit data playback.

## 6.8 Data Logging

---

The Data Logging section allows you to launch Support platform directly to view all records of all feedback or no feedback data loggings on the diagnostic system. For more details, see [Data Logging](#).

## 6.9 Uninstall Apps

---

This section allows you to manage the software applications installed on the MaxiCOM diagnostics system. Selecting this section opens a managing screen, on which you can check all available vehicle diagnostic applications.

Select the vehicle software you want to delete by tapping on the vehicle manufacturer icon, the selected item will display a blue mark at the upper-right corner. Tap the **Delete** button on the Top Toolbar to delete the software from the system database.

# 7 Settings

Access the Settings menu to adjust default settings and view information about the MaxiCOM system. The following options are available for the MaxiCOM system settings:

- **Unit**
- **Language**
- **Printing Settings**
- **Report Settings**
- **Push Notifications**
- **Auto Update**
- **Vehicle List**
- **System Settings**
- **About**

This section describes the procedures to adjust the device's system settings.

## 7.1 Unit

---

This option allows you to adjust the measurement unit for the diagnostic system.

- **To adjust the unit setting**
  1. Tap the **Settings** application on the MaxiCOM Job Menu.
  2. Tap the **Unit** option on the left column.
  3. Select the appropriate measurement unit. A check icon will display to the right of the selected unit.
  4. Tap the **Home** button on the top-left corner to return to the MaxiCOM Job Menu, or select another setting option for system setup.

## 7.2 Language

---

This option allows you to adjust the display language for the MaxiCOM system.

- **To adjust the language setting**
  1. Tap the **Settings** application on the MaxiCOM Job Menu.
  2. Tap the **Language** option on the left column.
  3. Select an appropriate language. A check will display to the right of the selected language.

4. Tap the **Home** button on the top-left corner to return to the MaxiCOM Job Menu, or tap another setting to adjust.

## 7.3 Printing Settings

---

Configure this option to enable the tablet to print via network.

➤ **To setup the printer connection**

1. Tap the **Settings** application on the MaxiCOM Job Menu.
2. Tap the **Printing Settings** option on the left column.
3. Tap the **Print via PC-Link** or **Print via Wi-Fi** to activate the printing function, which enables the device to send files to the printer through the PC via Wi-Fi or Ethernet connection.
4. Tap the **Home** button on the top-left corner to return to the MaxiCOM Job Menu, or tap another setting to adjust.

### 7.3.1 Printing Operations

If the Wi-Fi printer is not available, you can use your PC to print the data on the tablet. Follow the instructions below to operate.

➤ **To install the PC Link driver program**

1. Download the **Maxi PC Suite** software from [www.autel.com](http://www.autel.com) > **Support** > **Downloads** > **Autel Update Tools**, and install it to your windows-based computer.
2. Double click on **Setup.exe**.
3. Select the installation language and the wizard will load momentarily.
4. Follow the instructions on the screen and click **Next** to continue.
5. Click on **Install** and the printer driver program will be installed onto the PC.
6. Click on **Finish** to complete the installation.

---

 **NOTE**

The MaxiSys Printer tab is selected by default after the installation. The PC, printer and the tablet must be connected to the same network.

---

This section describes how to receive files from the tablet and perform printing through the computer.

---

## NOTE

- Make sure the tablet is connected to the same network with your computer, either via Wi-Fi or LAN, before printing.
- Make sure the computer installed with the Printing Services program is connected to a printer.

---

### ➤ To perform printing through the PC

1. Run the **PC Link** program on the PC.
2. Select the **MaxiSys Printer** tab.
3. Tap the **Print** button on the Top Toolbar of the tablet. A test document will be sent to the PC.
  - ✧ If the **Auto Print** option in the MaxiSys Printer is selected, the MaxiSys Printer will print the received document automatically.
  - ✧ If the **Auto Print** option is not selected, click **Open PDF File** to view all the temporary files. Select the file(s) needed for printing, then tap **Print**.

---

## NOTE

To confirm that the printer is functioning normally, you can click **Test Print** in the PC Link program to test.

---

## 7.4 Report Settings

---

This option automatically synchronizes the diagnostics information of the vehicle to the vehicle history and forms a diagnostic report for the user to upload. Tap the **ON/OFF** button to enable/disable the Report Upload to Cloud function. The button appears blue if the function is enabled and displays gray if the function is disabled.

---

## NOTE

Make sure the tablet is connected to the Internet while uploading reports.

---

## 7.5 Push Notifications

---

This option allows you to manage notifications. The Notification Preferences option is turned on by default and cannot be turned off by users so that certain system notifications such as system security warnings won't be blocked.

### ➤ To manage other notifications

1. Tap the **Settings** application on the MaxiCOM Job Menu.
2. Tap the **Push Notifications** option on the left column.
3. Tap the ▼ button on the right of the Other Notifications option to open a drop-down list.
4. There are four options: Enable All Notifications, Limit to 3 Notifications or Less Per Week, Limit to 1 Notification Per Week, and Disable All Notifications.

Select whichever you prefer.

---

## NOTE

- Notifications will display on the screen. Slide the screen from top to check the received messages. If the message list covers more than one screen, slide the list up or down to view them.
  - Tapping a specific message launches the corresponding application. For example, if you tap on an Update notification, the Update application will be launched.
- 

## 7.6 Auto Update

---

The Auto Update allows the tool to automatically update the OS, the MaxiCOM system, and the vehicle coverage software. Each can be configured to update automatically at a specified time. Tap the **ON/OFF** button to enable/disable the desired automatic update time.

### ➤ To set auto system or vehicle update

1. Tap the **Settings** application on the MaxiCOM Job Menu.
2. Tap the **Auto Update** option on the left column. The three auto update items will display on the right of the screen.
3. Select the update type to schedule. Toggle the button to **ON**.
4. Tap on the time to set the time of the day for updating. If the update time is set and the device is connected to the Internet, the selected software will be automatically updated at the configured time.

## 7.7 Vehicle List

---

This option allows you to sort the vehicles either by alphabetical order or by frequency of use.

### ➤ To adjust the vehicle list setting

1. Tap **Settings** on the MaxiCOM Job Menu.
2. Tap **Vehicle List** on the left column.
3. Select the desired sort type. A check mark will display to the right of the selected item.
4. Tap the **Home** button on the top-left corner to return to the MaxiCOM Job Menu, or select another setting option for the system setup.

## 7.8 System Settings

---

This function provides you with direct access to the Android system settings interface, where you can adjust various system settings for the Android operating system, regarding wireless and network settings, various device settings such as sound and display, as well as system security settings, and check related information about the Android system. Refer to your Android documentation for additional information.

## 7.9 About

---

The About option provides information of the MaxiCOM diagnostics device including the product name, version, hardware, and serial number.

- **To check the MaxiCOM product information in About**
  1. Tap the **Settings** application on the MaxiCOM Job Menu.
  2. Tap the **About** option on the left column. The product information displays on the right of the screen.
  3. Tap the **Home** button on the top-left corner to return to the MaxiCOM Job Menu or select another setting to adjust.



# 8 Update

The Update application on the tablet downloads the latest version of the software. The updates improve the MaxiCOM applications' capabilities, typically by adding new tests, new model coverage or by adding new or enhanced applications.

The tablet automatically searches for available updates for all of the MaxiCOM software when it is connected to a network. Any updates that are found can be downloaded and installed on the device.



---

## NOTE

Ensure the tablet is registered before utilizing the Update application. See [Autel User Center](#) for details.

---

### ➤ To update the software

1. Ensure the tablet is connected to a power source and has a stable Internet connection.
  2. Tap the **Update** application button from the MaxiCOM Job Menu. The Update application screen displays.
  3. On the Update screen, tap the **Get** button to update the specific item(s) or tap the **Update All** button to update all available items.
  4. Tap **More** to view the details of all the available updates. You can also tap the **Get** or **Update All** button for update.
  5. During the update, tap the  icon to suspend the updating process. Tap the  icon to resume the update and the process will continue from the pause point.
  6. When the updating process is completed, the software will be installed automatically. The previous version will be replaced.
- 

## NOTE

For the account management, proceed to the Member Center tab.

---

# 9 VCI Manager

This application pairs the tablet with the MaxiVCI Mini, checks the communication status and update the VCI firmware.

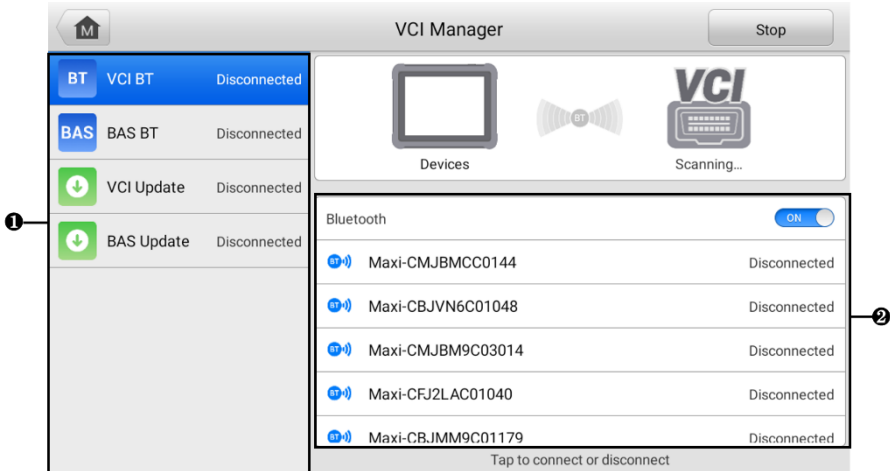

**Figure 9-1 VCI Manager Screen**

1. Connection Mode — there are four connection modes available for selection. The connection status is displayed alongside.
  - VCI BT — when the VCI is paired to a device via Bluetooth, the connection status displays as “Connected.” Otherwise, it displays as “Disconnected.”
  - BAS BT — when paired to a battery tester via Bluetooth, the connection status displays as “Connected.” Otherwise, it displays as “Disconnected.”
  - VCI Update — connects the VCI to the diagnostic tablet via Bluetooth first, then updates the VCI firmware through the tablet.
  - BAS Update — updates the BT506 battery tester’s firmware via Internet through the tablet.

2. Settings Section

This section allows you to manage wireless pairing or set up network connection. Toggle the **ON/OFF** button to **ON**. The available devices for pairing will display. Tap the needed one to start pairing.

## 9.1 VCI Bluetooth Pairing

---

The MaxiVCI Mini needs to be connected to a vehicle, so that it is powered during the synchronization procedure. Ensure the tablet has sufficient battery power or is connected to an external power supply.

➤ **To pair the MaxiVCI Mini with the tablet**

1. Power on the tablet.
2. Insert the 16-pin vehicle data connector of the MaxiVCI Mini to the vehicle data link connector (DLC).
3. Tap the **VCI Manager** application on the MaxiCOM Job Menu of the tablet.
4. Select **VCI BT** from the Connection Mode list on the left column.
5. Toggle the **ON/OFF** button to ON. Tap the **Scan** button at the top-right corner. Now the device starts searching for available pairing units.
6. The device name may display as “Maxi-” suffixed with a serial number. Select the appropriate device for pairing.
7. When pairing is successfully done, the connection status displayed to the right of the device name is shown as “Connected.”
8. Once connected, the BT badge displays at the bottom-right corner of the VCI Manager shortcut, and the Connection LED on the MaxiVCI Mini illuminates solid blue, which signifies that the tablet is connected to the MaxiVCI Mini, and is ready to perform vehicle diagnosis. If you need to disconnect the connected device, tap it again.
9. Tap the **Home** button on the top-left to return to the MaxiCOM Job Menu.

---

🔗 **NOTE**

A MaxiVCI Mini can only be connected to one tablet at a time, and once it's connected, the device will not be discoverable to other devices.

---

## 9.2 BAS Bluetooth Pairing

---

The BT506 battery tester device can be connected with the tablet via Bluetooth. Ensure that the BT506 battery tester is sufficiently charged or is connected to an external power supply before use.

➤ **To pair the Battery Tester with the tablet**

1. Power on the diagnostic tablet and the battery tester.
2. Connect the red clamp to the positive (+) battery terminal and the black clamp to the negative (-) battery terminal.
3. Tap **VCI Manager** on the MaxiCOM Job Menu of the tablet.
4. Select **BAS BT** from the Connection Mode list on the left column.

5. Toggle the Bluetooth **ON**. Tap **Scan** at the top-right corner of the screen. The device will start to search for available units to pair with.
6. Depending on the type of battery tester, the device name may appear as “Maxi-” suffixed with the battery tester’s serial number. Select the appropriate device for pairing.
7. When paired successfully, the connection status reads “Connected.”

## 9.3 VCI Update

---

### 9.3.1 Update via Tablet

Before updating the VCI firmware, make sure the tablet has a stable network connection.

➤ **To update the MaxiVCI Mini firmware via tablet**

1. Power on the tablet.
2. Using a Mini USB cable to connect the MaxiVCI Mini to the tablet.
3. Tap the **VCI Manager** application on the MaxiCOM Job Menu of the tablet.
4. Select **VCI Update** from the Connection Mode list on the left column.
5. If the installed version is the latest one, the screen will prompt that the software is up to date, otherwise, the current version and the latest version will display on the screen. Tap **Update Now** to update the VCI firmware if available.

### 9.3.2 Update via PC

➤ **To update the MaxiVCI Mini firmware via PC**

1. Download the **Maxi PC Suite** software from [www.autel.com](http://www.autel.com) > **Support** > **Downloads** > **Autel Update Tools**, and install it onto your PC.
2. Using a Mini USB cable to connect the MaxiVCI Mini to the PC.
3. Launch the **PC Suite** on the PC which is installed after the installation of **Maxi PC Suite** and click the **MaxiVCI Mini** icon in the Device Selection window.
4. The PC will automatically recognize the MaxiVCI Mini.
5. Click **Update** to complete the update if an update is available.

---

 **NOTE**

Do not leave the VCI Update page during upgrade.

---

## 9.4 BAS Update

---

Before updating the battery tester firmware, please make sure the network connection is stable.

➤ **To update the battery tester's firmware**

1. Power on the diagnostic tablet and the battery tester.
2. Connect the battery tester to the tablet via Bluetooth.
3. Tap the **VCI Manager** application on the MaxiCOM Job Menu of the tablet.
4. Select **BAS Update** from the Connection Mode list on the left column.
5. If the installed version is the latest one, the screen will prompt that the software is up to date, otherwise, the current version and the latest version will display on the screen. Tap **Update Now** to update the BAS firmware if available.

---

 **NOTE**

Do not leave the BAS Update page during upgrade.

---

# 10 Battery Test

The Battery Test application allows the user to perform in-vehicle battery test and out-vehicle battery test functions when the BT506 battery tester is connected to the MaxiCOM MK808Z-BT tablet and a battery. The BT506 battery tester enables technicians to view the health status of the vehicle's battery and electrical system.

---

**NOTE**

The BT506 battery tester needs to be purchased separately.

---

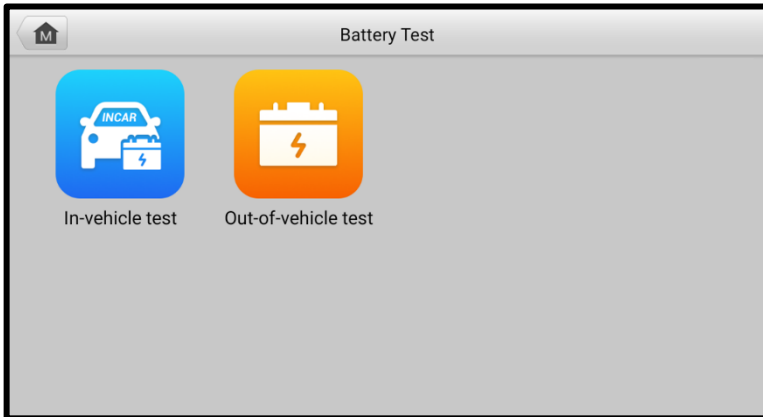

**Figure 10-1 Battery Test Screen**

# 10.1 MaxiBAS BT506 Battery Tester

## 10.1.1 Function Description

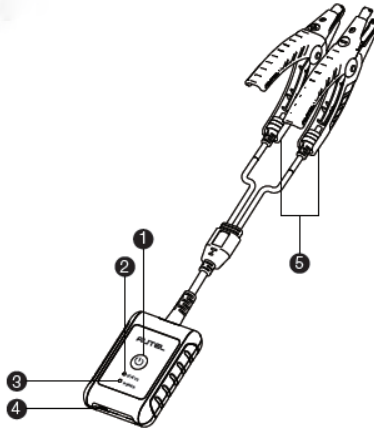

**Figure 10-2 MaxiBAS BT506 Tester**

1. Power Button
2. Status LED
3. Power LED
4. USB Port
5. Battery Clamp Cable

**Table 10-1 LED Description**

LED	Color	Description
<b>Status LED</b>	Flashing Green	The tester is communicating via USB cable.
	Flashing Blue	The tester is communicating via Bluetooth.
	Flashing Red	Battery clamps are connected to the wrong battery terminals.

LED	Color	Description
Power LED	Solid Green	The tester is powered on and the battery is sufficiently charged.
	Flashing Green	The tester is charging. (Turns solid green when battery is fully charged.)
	Solid Red	The device is in boot mode.
	Flashing Red	The battery level is low. Please charge.

## 10.2 Power Sources

---

The MaxiBAS BT506 tester can receive power from the following sources:

- Internal Battery Pack
- AC/DC Power Supply

---

### **!** IMPORTANT

Do not charge the tester when the temperature is below 0 °C (32 °F) or above 45 °C (113 °F).

---

### 10.2.1 Internal Battery Pack

The MaxiBAS BT506 battery tester can be powered with the internal rechargeable battery.

### 10.2.2 AC/DC Power Supply — Using Power Adapter

The MaxiBAS BT506 battery tester can be powered from an electrical outlet using the AC/DC power adapter. The AC/DC power supply also charges the internal battery pack.



## 10.2.3 Technical Specifications

Table 10-2 *Technical specifications*

Item	Description
Connectivity	<ul style="list-style-type: none"><li>● USB 2.0, Type C</li><li>● Bluetooth 4.2</li></ul>
Input Voltage	5 V DC
Working Current	< 150 mA at 12 V DC
Internal Battery	3.7 V/800 mAh Lithium-ion Polymer battery
CCA Range	100 to 2000 A
Voltage Range	1.5 to 16 V
Working Temp.	- 10 °C to 50 °C (14 °F to 122 °F)
Storage Temp.	- 20 °C to 60 °C (- 4 °F to 140 °F)
Dimension (L x W x H)	107 mm (4.21") x 75 mm (2.95") x 26 mm (1.02") (clamp cable not included)
Weight	320 g (0.7 lbs.)

## 10.3 Test Preparation

---

### 10.3.1 Inspect the Battery

Before starting a test, inspect the battery for:

- Cracking, buckling or leaking. If you see any of these defects, replace the battery.
- Corroded, loosen or damaged cables and connections. Repair or replace as needed.
- Corrosion on the battery terminals, and dirt or acid on the case top. Clean the case and terminals using a wire brush and a mixture of water and baking soda.

## 10.3.2 Connect the Battery Tester

### ➤ To pair with the MaxiCOM tablet

1. Turn on both the MaxiCOM MK808Z-BT tablet and the BT506 battery tester. Ensure that the units are sufficiently charged before you begin.
2. Enable Bluetooth on the tablet by tapping **VCI Manager > BAS BT**. Toggle the Bluetooth **ON**. Tap **Scan** at the top-right corner. The device will start to search for available pairing units.
3. Depending on the type of battery tester, the device name may display as "Maxi-" suffixed with a serial number. Select the appropriate device for pairing.
4. When paired successfully, the connection status will read "Connected."

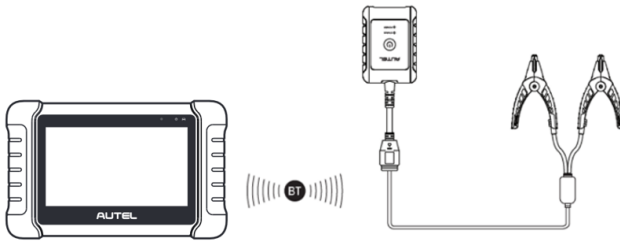

**Figure 10-3 Battery Tester Connection Example 1**

### ➤ To connect to a battery

1. Connect the red clamp to the positive (+) terminal of the battery.
2. Connect the black clamp to the negative (-) terminal of the battery.

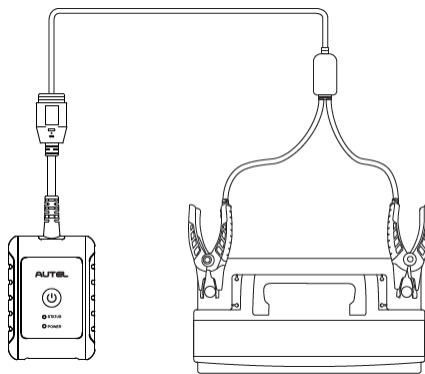

**Figure 10-4 Battery Tester Connection Example 2**

## 10.4 In-vehicle Test

The In-vehicle Test is used for testing batteries that are installed in a vehicle. An in-vehicle test includes the Battery Test, Starter Test, and Generator Test. These tests help determine the health of the battery, the starter, and the generator.

### ! IMPORTANT

A disclaimer will appear when first accessing any function on the **Home** screen. Please read the end-user agreement and tap **Accept** to continue. If you tap **Decline**, you will not be able to use the features properly.

Prior to testing any battery, ensure that the battery tester is paired with the tablet via Bluetooth and connected properly to a battery.

#### ➤ To start the in-vehicle test





1. Tap **Battery Test** on the MaxiCOM Job Menu. Select **In-vehicle Test**.
2. Confirm the vehicle information on the left side of the screen. Make sure the VIN is entered.
3. Confirm your battery information, including voltage, type, standard, and capacity. Tap **Next** to continue the in-vehicle test functions.

Type	Standard	Capacity
FLOODED	CCA	100
AGM	SAE	105
AGM SPIRAL	CA	110

Figure 10-5 *Battery information Screen*

Please refer to the table below for a list of buttons that may appear when accessing the functions:

**Table 10-3 Top Toolbar Buttons**

Button	Name	Description
	<b>Battery Connection</b>	The value on the icon indicates the real-time voltage of the tested battery. In the battery test, the button will turn green if the battery is good. Otherwise, it will turn red.
	<b>Next</b>	Tap to proceed.
	<b>Home</b>	Returns to the battery test main screen.
	<b>Back</b>	Returns to the previous screen.
	<b>Exit</b>	Returns to the Job Menu.

### 10.4.1 Battery Test

1. Follow the on-screen instructions. Check the boxes once all required tasks are completed, and tap **Start Testing**.

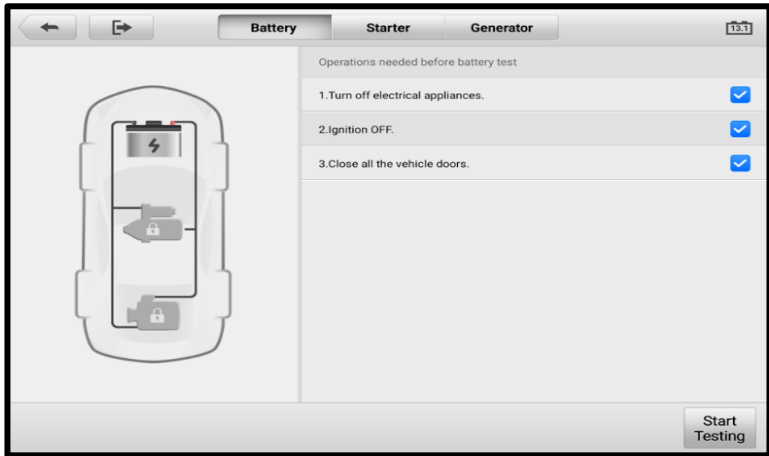

**Figure 10-6 Battery Screen**

2. Wait until the test is completed. The test results will be displayed on the tool.



**Figure 10-7 Battery Test Results Screen**

The battery test results include a color-coded results summary and a list of test data. Possible in-vehicle test results are as follows:

**Table 10-4 Test Results**

Result	Description
<b>Good Battery</b>	Battery is good.
<b>Good &amp; Recharge</b>	Battery is good but insufficiently charged. Recharge the battery.
<b>Charge &amp; Retest</b>	Battery requires charge to determine its condition.
<b>Bad Cell</b>	Replace the battery.
<b>Replace Battery</b>	Replace the battery.

**NOTE**

Please always complete the battery test before you proceed to the starter and generator tests.

### 10.4.2 Starter Test

Follow the on-screen instructions to complete the test. Start the engine and let it idle. The test results will appear as follows:

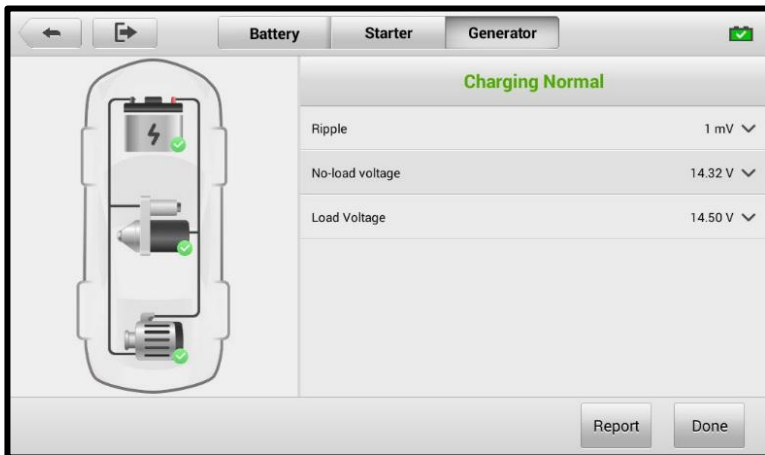

**Figure 10-8 Starter Test Result Screen**

**Table 10-5 Starter Test Results**

Result	Description
<b>Cranking Normal</b>	The starter is good.
<b>Current Too Low</b>	Low momentary discharge capacity.
<b>Voltage Too Low</b>	Low battery storage capacity.
<b>Not Started</b>	The starter is not detected for starting.

### 10.4.3 Generator Test

Follow the on-screen instructions to complete the test. The test results will appear as follows:

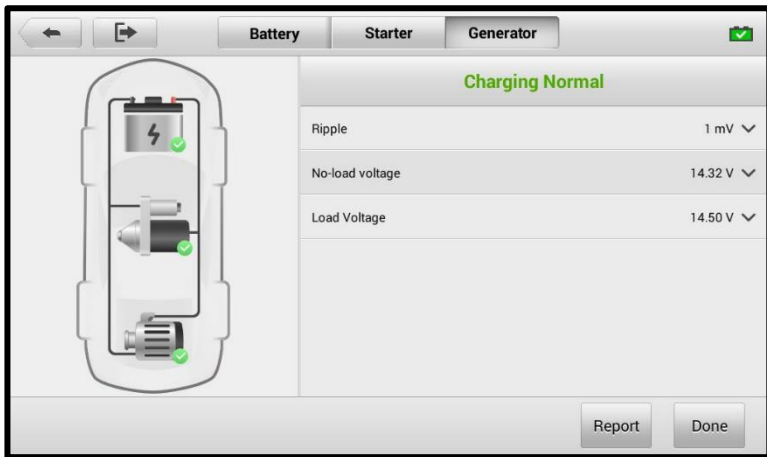

**Figure 10-9 Generator Test Results Screen**

**Table 10-6 Generator Test Results**

<b>Result</b>	<b>Description</b>
<b>Charging Normal</b>	The generator is functioning normally.
<b>Output Too Low</b>	<ul style="list-style-type: none"> <li>● The belt linking the starter and the generator is loose;</li> <li>● The cable linking the starter and battery is loose or corroded.</li> </ul>
<b>Output Too High</b>	<ul style="list-style-type: none"> <li>● The generator is not properly connected to the ground;</li> <li>● The voltage adjuster is broken and needs replacement.</li> </ul>
<b>Ripple Too Large</b>	The commutation diode is broken.
<b>No Output</b>	<ul style="list-style-type: none"> <li>● The cable is loose;</li> <li>● Some vehicles with power management systems do not provide path for charging due to the sufficient load capacity of the battery;</li> <li>● The generator or the voltage adjuster is broken and needs replacement.</li> </ul>

## 10.5 Out-of-vehicle Test

---

Out-of-vehicle Test is used to test the condition of batteries that are not connected to a vehicle. This function aims to check the health status of the battery only.

### 10.5.1 Test Procedure

➤ **To start the Out-of-vehicle Test**

1. Connect the tester clamps to the battery terminals.
2. Tap **Battery Test** on the MaxiCOM Job Menu. Select **Out-of-vehicle Test**. Select the appropriate battery type, rating standard, and CCA value. Tap **Start Testing** to start the test.



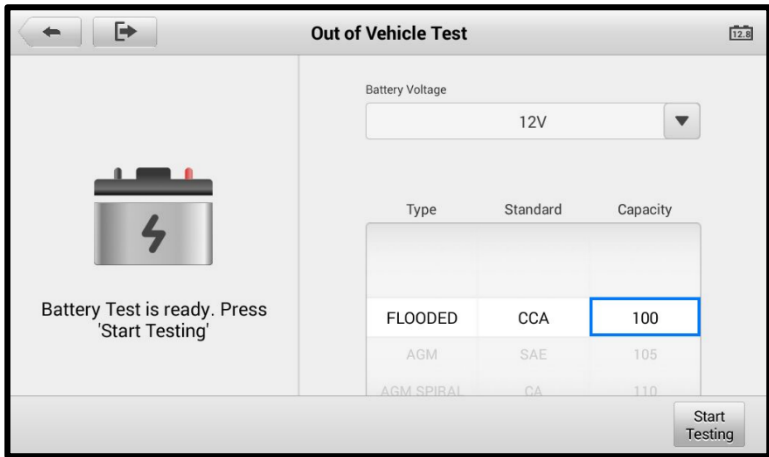

**Figure 10-10 Out-of-vehicle Test Screen**

3. The test results will display in a few seconds.

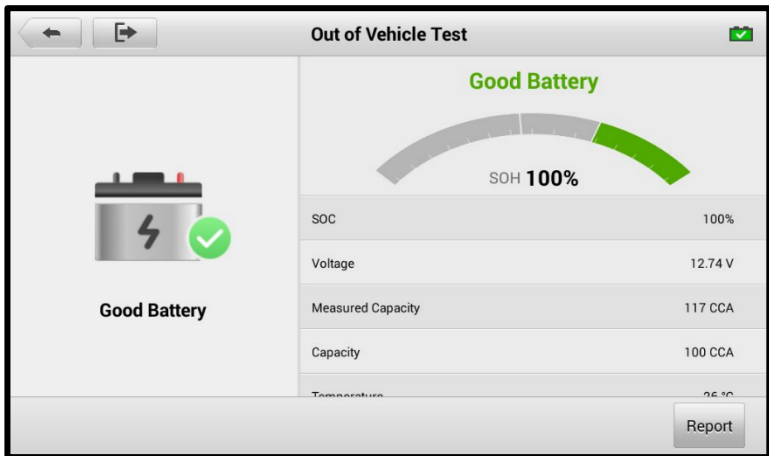

**Figure 10-11 Out-of-vehicle Test Results Screen**

## 10.5.2 Test Results

**Table 10-7 Out-of-vehicle Test Results**

<b>Result</b>	<b>Description</b>
<b>Good Battery</b>	Battery meets required standards.
<b>Good &amp; Recharge</b>	Battery is good, but low on charge. Fully charge the battery. Check for causes of low charge.
<b>Charge &amp; Retest</b>	Battery requires charge to determine its condition.
<b>Replace Battery</b>	Battery fails to meet industry-accepted standards.
<b>Bad Cell</b>	Battery fails to meet industry-accepted standards.

# 11 MaxiViewer

The MaxiViewer allows you to search the functions supported by our tools and the software version information. There are two ways of searching, either by searching the tool and the vehicle or searching the functions.

## ➤ To Search by the vehicle

1. Tap the **MaxiViewer** application on the MaxiCOM Job Menu. The Function Viewer screen displays.
2. Tap the tool name on the top-left corner to drop down the tool list. Tap the one you want to search.
3. Tap the vehicle brand, model, and year you want to search.

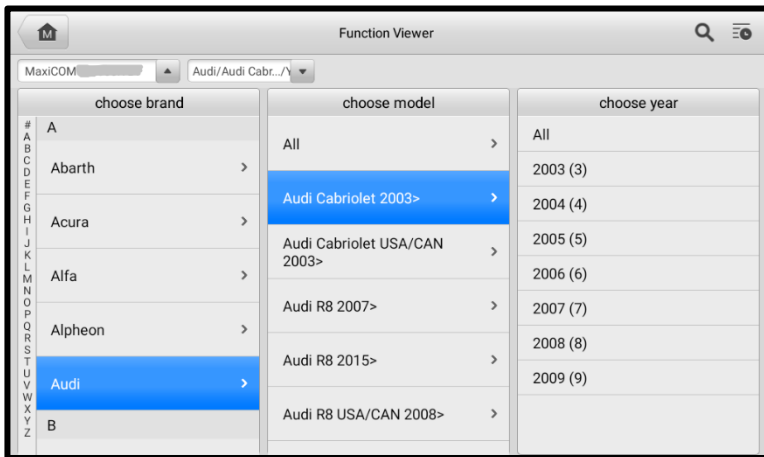

**Figure 11-1 Function Viewer Screen 1**

4. All the functions support by the selected tool for the selected vehicle will display as several columns.

The screenshot shows the 'Function Viewer' interface. At the top, there are dropdown menus for 'MaxiCOM', 'Audi/Audi Cabr../2008', 'System', 'Engine', and 'Type'. Below these is a table with the following columns: System, Engine, Type, Function, Sub function, and Version.

System	Engine	Type	Function	Sub function	Version
01 - Engine Control Module 1	ASB 3.0L TDI / 171kW	Convertible	Aftertreatment	Particulate filter malfunction	Above Audi_V3.50
01 - Engine Control Module 1	BKN 3.0L TDI / 150kW	Convertible	Aftertreatment	Particulate filter malfunction	Above Audi_V3.50
01 - Engine Control Module 1	BPP 2.7L TDI / 132kW	Convertible	Aftertreatment	Particulate filter malfunction	Above Audi_V3.50
01 - Engine Control Module 1	BPW 2.0L TDI / 103kW	Convertible	Aftertreatment	Particulate filter malfunction	Above Audi_V3.50
01 - Engine Control Module 1	BRC 2.0L TDI / 100kW	Convertible	Aftertreatment	Particulate filter malfunction	Above Audi_V3.50
01 - Engine Control Module 1	BSG 2.7L TDI / 120kW	Convertible	Aftertreatment	Particulate filter malfunction	Above Audi_V3.50

**Figure 11-2 Function Viewer Screen 2**

➤ **To search by the functions**

1. Tap the **MaxiViewer** application on the MaxiCOM Job Menu. The Function Viewer screen displays.
2. Tap the tool name on the top-left to drop down the tool list. Tap the one you want to search.
3. Type the function you want to search in the top-right search column. All the vehicles with this function will be listed with several columns, including feature, function, and version.

The screenshot shows the 'Function Viewer' interface with a search filter applied. The search bar at the top right contains 'ECU Information'. The table below shows search results with columns: Brand, Model, Year, System, Sub system, Function, Sub function, and Version.

Brand	Model	Year	System	Sub system	Function	Sub function	Version
Jaguar	F-Type	2014-2015	Passenger's door module	/	ECU information	/	Above Jaguar_V1.20
Jaguar	F-Type	2014-2015	Passenger's door module	/	ECU information	/	Above Jaguar_V1.20
Jaguar	F-Type	2014-2015	Transmission control module	/	ECU information	/	Above Jaguar_V1.20
Jaguar	F-Type	2014-2015	Transmission control module	/	ECU information	/	Above Jaguar_V1.20
Jaguar	F-Type	2014-2015	Body control module	/	ECU information	/	Above Jaguar_V1.20
Jaguar	F-Type	2014-2015	Body control module	/	ECU information	/	Above Jaguar_V1.20

**Figure 11-3 Function Viewer Screen 3**

# 12 Support

This application launches the Support platform which synchronizes Autel's online service base station with the tablet. Connected to Autel's service channel and online communities, the Support application provides the quickest way for problem solutions, allowing you to send help requests to obtain direct service and support.

## 12.1 Support Screen Layout

---

The Support application interface is navigated by the Home button on the Top Toolbar. And the main section of the Support screen is divided into two sections. The narrow column on the left is the main menu; select one subject from the main menu to display the corresponding function screen on the right.

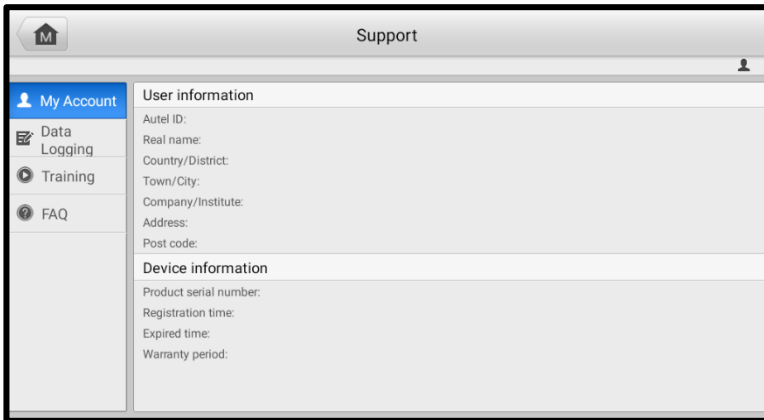

**Figure 12-1 Support Application Screen**

## 12.2 My Account

---

The My Account screen displays the comprehensive information of the user and the product, which is synchronized with the on-line registered account, including user information and device information.

- User Information — displays detailed information of your registered online Autel account, such as your Autel ID, name, address, and other contact information.

- Device Information — displays the registered product information, including the product serial number, registration time, expired time, and warranty period.

## 12.3 Data Logging

---

The Data Logging screen keeps records of all **Feedback** (submitted), **No Feedback** (not submitted but saved) or **History** (up to the latest 20 test records) data loggings on the diagnostic system. You can edit and send test records by using the Data Logging function. Autel support personnel will receive and process submitted reports through the Support platform.

➤ **To make a reply in a Data Logging session**

1. Tap on the **Feedback** tag to view the list of submitted data loggings.
2. Select a specific item to view the latest update of the processing progress.
3. Tap on the input field at the bottom of the screen and enter your reply, or tap the **Audio** button to record a voice message or the **Camera** button to take a screenshot.
4. Tap **Send** to deliver your message to Autel support.

## 12.4 Training

---

The Training section provides quick links to Autel's online video library. Select a video channel by language to see all available online tutorial videos on topics such as product usage techniques and vehicle diagnostics practice.

## 12.5 FAQ

---

The FAQ section provides comprehensive references for all questions frequently asked and answered about the use of Autel's online member account, shopping, and payment procedures.

- Account — displays questions and answers about the use of Autel's online user account.
- Shopping — displays questions and answers about online product purchase methods or procedures.
- Payment — displays questions and answers about online product payment methods or procedures.

# 13 Remote Desktop

The Remote Desktop application launches the TeamViewer QuickSupport program, which is a simple, fast, and secure remote-control interface. You can use the application to receive remote support from Autel's support center, colleagues or friends, by allowing them to control your MaxiCOM tablet on their PC via the TeamViewer software.

If you think of a TeamViewer connection as a phone call, the TeamViewer ID would be the phone number under which all TeamViewer Clients can be reached separately. Computers and mobile devices that run TeamViewer are identified by a unique global ID. The first time the Remote Desktop application is launched, this ID is generated automatically based on the hardware characteristics and will not change later on.

Make sure the tablet is connected to the Internet before launching the Remote Desktop application, so that the tablet is able to receive remote support from a third party.

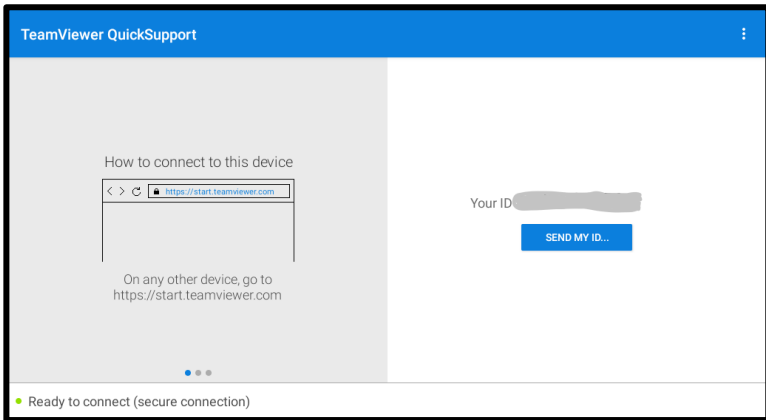

**Figure 13-1 Remote Desktop Screen**

- **To receive remote support from a partner**
  1. Power on the tablet.
  2. Tap the **Remote Desktop** application on the MaxiCOM Job Menu. The TeamViewer QuickSupport screen appears and the device ID is generated and shown.
  3. Your partner must install the Remote Control software to his/her PC by downloading the TeamViewer program (full version) online (see

<http://www.teamviewer.com>), and then launch the software.

4. Provide your ID to your partner and wait for him/her to send you a remote-control request.
5. A prompt will appear asking you to allow remote control on your device.
6. Tap **Allow** to accept, or tap **Deny** to reject.

Refer to the associated TeamViewer documents for additional information.



# 14 MaxiVideo

The MaxiVideo application configures the MaxiCOM diagnostics tablet to operate as a digital video scope by simply connecting the tablet to a MaxiVideo Camera. This function allows you to examine difficult-to-reach areas normally hidden from sight, with the ability to record digital still images and videos, which offers you an economical solution to inspect machinery, facilities, and infrastructure in a safe and quick way.

---

 **NOTE**

1. The MaxiVideo Camera and its fittings are additional accessories, and need to be purchased separately. Both sizes (8.5 mm and 5.5 mm) of the imager head are optional and available for purchase.
  2. This function is compatible with the MaxiVideo Camera in models MV105S, MV108S, MV105, and MV108.
  3. Connect the tablet with MaxiVideo Camera using the USB cable. For detailed operation instructions, please refer to the Quick Reference Guide for the MaxiVideo Camera.
-

# 15 Quick Link

The Quick Link application provides you with convenient access to Autel's official website and many other well-known sites in automotive service industry to provide technical help, knowledge bases, forums, and training and expertise consultations.

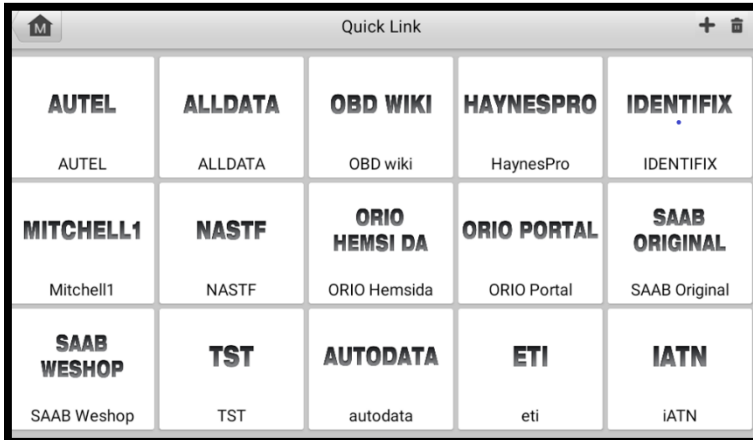

**Figure 15-1 Quick Link Screen**

➤ **To open a quick link**

1. Tap the **Quick Link** application on the MaxiCOM Job Menu. The Quick Link application screen appears.
2. Select a website thumbnail from the main section. The Chrome browser is launched and the selected website is opened.

➤ **To manage the quick links**

1. Tap the **Quick Link** application on the MaxiCOM Job Menu. The Quick Link application screen appears.
2. Tap the **+** icon on the upper-right corner to add websites. Tap the **🗑️** icon to delete websites.

# 16 Autel User Center

Software updates are available for free for the first year from the date of purchase. The Autel User Center application allows you to register your tool to download the latest released software, thereby enhancing the functionality of the MaxiCOM application by adding new vehicle models or enhanced applications to the database.

There are two ways for product registration:

## A. Register the product using the MaxiCOM tablet

### ➤ To log in with your account and register your tool

1. Tap **Autel User Center** from the MaxiCOM Job Menu. The following screen displays.

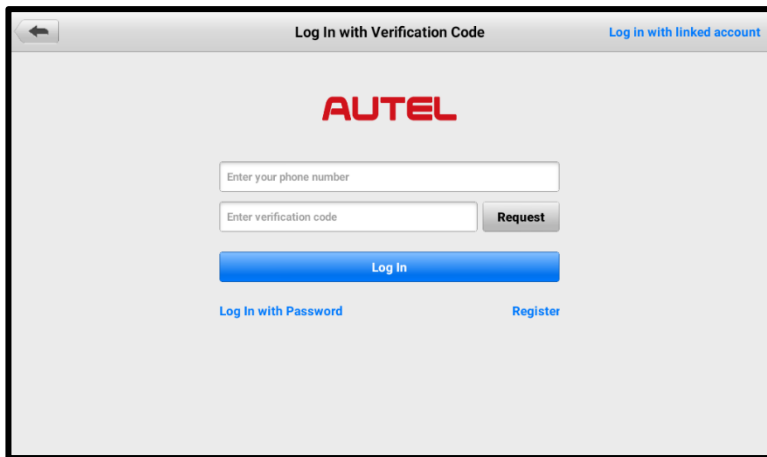

**Figure 16-1 Autel User Center Screen**

2. If you already have an Autel ID, you can log in with your phone number and verification code, or tap **Log In with Password** to log in with your Autel ID and password. If you don't have an Autle ID yet, tap **Register** to create an Autel ID.
3. Once your account is successfully registered, you will enter the main menu of the Autel User Center.
4. Select **Device Management** on the main menu.

5. Tap the **Link Device** button on the upper-right corner of the Device Management screen. The serial number and password of the device will automatically appear on the Link Device screen.
6. Tap the **Link** button to complete the product registration.

## **B. Register the product on the Autel website**

### ➤ **To register the diagnostic device**

1. Visit the website: [pro.autel.com](http://pro.autel.com).
2. If you have an Autel account, sign in with your account ID and password and skip to step 7.
3. If you are a new member to Autel, click the **Register** button to create your Autel ID.
4. Enter the required personal information in the input fields.
5. Enter your email address, then click **Request**. You will receive an email from Autel with your verification code. Open the email and copy the code into the proper input box.
6. Set a password for your account, and enter the password again to confirm. Read the **Autel User Service Agreement** and **Autel Privacy Policy**, then check the box to accept the terms. After all the information is entered, click **Register**. A Product Registration screen will appear.
7. Your product serial number and password are required to complete your registration. To find your serial number and password on the tool: go to **Settings > About**.
8. Enter your tool's serial number and password on the Product Registration screen. Enter the CAPTCHA code and click **Submit** to complete your registration procedure.

# 17 Maintenance and Service

To ensure that the MaxiCOM diagnostic tablet performs at its optimum level, we advise that the product maintenance instructions covered in this section is read and followed.

## 17.1 Maintenance Instructions

---

The following shows how to maintain your devices, together with precautions to take.

- Use a soft cloth and alcohol or a mild window cleaner to clean the touch screen of the tablet.
- Do not use any abrasive cleansers, detergent, or automotive chemicals to the tablet.
- Maintain the devices in dry conditions and keep them within normal operating temperatures.
- Dry your hands before using the tablet. The touch screen of the tablet may not work if the touch screen is moist, or if you tap the touch screen with wet hands.
- Do not store the device in humid, dusty or dirty areas.
- Check the housing, wiring, and connectors for dirt and damage before and after each use.
- After using the device, wipe the device housing, wiring, and connectors clean with a damp cloth.
- Do not attempt to disassemble your tablet.
- Do not drop or cause severe impact to the devices.
- Only use authorized battery chargers and accessories. Any malfunction or damage caused by the use of unauthorized battery charger and accessories will void the limited product warranty.
- Ensure that the battery charger does not come in contact with conductive objects.
- Do not use the tablet beside microwave ovens, cordless phones and some medical or scientific instruments to prevent signal interference.

## 17.2 Troubleshooting Checklist

---

### A. When the tablet does not work properly:

- Ensure the tablet has been registered online.
- Ensure the system software and diagnostic application software are properly updated.
- Ensure the tablet is connected to the Internet.
- Check all cables, connections, and indicators to see if the signal is being received.

### B. When battery life is shorter than usual:

- This may happen when you are in an area with low Wi-Fi signal strength. Turn off your device when not in use.

### C. When the tablet cannot be turned on:

- Ensure the tablet is connected to a power source or the battery is charged.

### D. When you are unable to charge the tablet:

- Your charger may be out of order. Contact your nearest dealer.
- You may be attempting to use the device in an overly hot/cold temperature. Try changing the charging environment.
- Your device may have not been connected to the charger properly. Check the connector.

---

#### NOTE

If your problems persist, please contact Autel's technical support personnel or your local selling agent.

---

## 17.3 About Battery Usage

---

Your tablet is powered by a built-in Lithium-ion Polymer battery. This means that, unlike other forms of battery technology, you can recharge your battery while some charge remains without reducing your tablet's autonomy due to the "battery memory effect" inherent in those technologies.

---

#### DANGER

1. The built-in Lithium-ion Polymer battery is factory replaceable only; incorrect replacement or tampering with the battery pack may cause an explosion.
  2. Do not use a damaged battery charger.
- 
- Do not disassemble or open crush, bend or deform, puncture or shred.
  - Do not modify or remanufacture, attempt to insert foreign objects into the battery,

expose to fire, explosion or other hazards.

- Make sure to use the charger and USB cables only that come together in the package. If you use the other charger and USB cables, you might incur malfunction or failure of the device.
- Only use the charging device that has been qualified with device as per the standard. Use of an unqualified battery or charger may present a risk of fire, explosion, leakage, or other hazards.
- Avoid dropping the tablet. If the tablet is dropped, especially on a hard surface, and the user suspects damage, take it to a service center for inspection.
- Move the tablet closer to your network's base station to improve battery life.
- The battery recharging time varies depending on the remaining battery capacity.
- Battery life inevitably shortens over time.
- Since over charging may shorten battery life, remove the tablet from its charger once it is fully charged. Unplug the charger, once charging is complete.
- Leaving the tablet in hot or cold places, especially inside a vehicle in summer or winter, may reduce the capacity and life of the battery. Always keep the battery within normal temperatures.

## 17.4 Service Procedures

---

This section introduces information for technical support, repair service, and application for replacement or optional parts.

### 17.4.1 Technical Support

If you have any question or problem on product operations, please contact us.

#### **Autel China Headquarters**

- **Phone:** +86 (0755) 8614-7779 (Monday-Friday, 9AM-6PM Beijing Time)
- **Email:** [support@autel.com](mailto:support@autel.com)
- **Address:** Floor 2, Caihong Keji Building, 36 Hi-tech North Six Road, Songpingshan Community, Xili Sub-district, Nanshan District, Shenzhen City, China
- **Web:** [www.autel.com](http://www.autel.com)

#### **Autel North America**

- **Phone:** 1-855-288-3587 (Monday-Friday, 9AM-6PM Eastern Time)
- **Email:** [ussupport@autel.com](mailto:ussupport@autel.com)
- **Address:** 36 Harbor Park Drive, Port Washington, New York, USA 11050

- **Web:** [www.autel.com/us](http://www.autel.com/us)

## **Autel Europe**

- **Phone:** +49(0)89 540299608 (Monday-Friday, 9AM-6PM Berlin Time)
- **Email:** [support.eu@autel.com](mailto:support.eu@autel.com)
- **Address:** Landsberger Str. 408, 81241 München, Germany
- **Web:** [www.autel.eu](http://www.autel.eu)

## **Autel APAC**

### **Japan:**

- **Phone:** +81-045-548-6282
- **Email:** [support.jp@autel.com](mailto:support.jp@autel.com)
- **Address:** 6th Floor, Ari-nadoribiru 3-7-7, Shinyokohama, Kohoku-ku, Yokohama-shi, Kanagawa-ken, 222-0033 Japan
- **Web:** [www.autel.com/jp](http://www.autel.com/jp)

### **Australia:**

- **Email:** [ausupport@autel.com](mailto:ausupport@autel.com)
- **Address:** Unit 5, 25 Veronica Street, Capalaba

## **Autel IMEA**

- **Phone:** +971 585 002709 (in UAE)
- **Email:** [imea-support@autel.com](mailto:imea-support@autel.com)
- **Address:** 906-17, Preatoni Tower (Cluster L), Jumeirah Lakes Tower, DMCC, Dubai, UAE
- **Web:** [www.autel.com](http://www.autel.com)

## **Autel Latin America**

### **Mexico:**

- **Phone:** +52 33 1001 7880 (Spanish in Mexico)
- **Email:** [latsupport@autel.com](mailto:latsupport@autel.com)
- **Address:** Avenida Americas 1905, 6B, Colonia Aldrete, Guadalajara, Jalisco, Mexico

### **Brazil:**

- **Email:** [brsupport@autel.com](mailto:brsupport@autel.com)



- **Address:** Avenida José de Souza Campos n° 900, sala 32 Nova Campinas Campinas – SP, Brazil
- **Web:** [www.autel.com/br](http://www.autel.com/br)

## 17.4.2 Repair Service

If it becomes necessary to return your device for repair, please contact us first and then download the repair service form from [www.autel.com](http://www.autel.com), and fill it in. The following information must be included:

- Contact name
- Return address
- Telephone number
- Product name
- Complete description of the problem
- Proof-of-purchase for warranty repairs
- Preferred method of payment for non-warranty repairs

---

### NOTE

For non-warranty repairs, payment can be made with Visa, Master Card, or with approved credit terms.

---

#### **Send the device to your local agent, or to the below address:**

Floor 2, Caihong Keji Building, 36 Hi-tech North Six Road, Songpingshan Community, Xili Sub-district, Nanshan District, Shenzhen City, China

## 17.4.3 Other Services

You can purchase the optional accessories directly from Autel's authorized tool suppliers, and/or your local distributor or agent.

Your purchase order should include the following information:

- Contact information
- Product or part name
- Item description
- Purchase quantity

# 18 Compliance Information

## FCC Compliance

**FCC ID: WQ8-MX808S-TS2152**

This device complies with Part 15 of the FCC rules and Industry Canada's license-exempt RSSs. Operation is subject to the following two conditions:

1. This device may not cause harmful interference.
2. This device must accept any interference received, including interference that may cause undesired operation.

Cet appareil est conforme aux CNR exempts de licence d'Industrie Canada. Son fonctionnement est soumis aux deux conditions suivantes:

1. Ce dispositif ne peut causer des interférences; et
2. Ce dispositif doit accepter toute interférence, y compris les interférences qui peuvent causer un mauvais fonctionnement de l'appareil.

---

### **WARNING**

Changes or modifications not expressly approved by the party responsible for compliance could void the user's authority to operate the equipment.

---

### **NOTE**

This equipment has been tested and found to comply with the limits for a Class B digital device, pursuant to Part 15 of the FCC Rules. These limits are designed to provide reasonable protection against harmful interference in a residential installation.

---

This equipment generates uses and can radiate radio frequency energy and, if not installed and used in accordance with the instructions, may cause harmful interference to radio communications. However, there is no guarantee that interference will not occur in a particular installation. If this equipment does cause harmful interference to radio or television reception, which can be determined by turning the equipment off and on, the user is encouraged to try to correct the interference by one or more of the following measures:

- Reorient or relocate the receiving antenna.
- Increase the separation between the equipment and receiver.
- Connect the equipment into an outlet on a circuit different from that to which the receiver is connected.

-- Consult the dealer or an experienced radio/TV technician for help.

Changes or modifications not expressly approved by the party responsible for compliance could void the user's authority to operate the equipment.

## **SAR**

The radiated output power of this device is below the FCC radio frequency exposure limits. Nevertheless, the device should be used in such a manner that the potential for human contact is minimized during normal operation.

The exposure standard for wireless devices employs a unit of measurement known as the Specific Absorption Rate, or SAR. The SAR limit set by the FCC is 1.6 W/Kg. Tests for SAR are conducted using standard operating positions accepted by the FCC with the device transmitting at its highest certified power level in all tested frequency bands.

Although the SAR is determined at the highest certified power level, the actual SAR level of the device while operating can be well below the maximum value. This is because the device is designed to operate at multiple power levels so as to use only the power required to reach the network. To avoid the possibility of exceeding the FCC radio frequency exposure limits, human proximity to antenna should be minimized.

## **RF WARNING STATEMENT**

The device has been evaluated to meet general RF exposure requirement. The device can be used in portable exposure condition without restriction.

## **RoHS COMPLIANCE**

This device is declared to be in compliance with the European RoHS Directive 2011/65/EU.

## **CE COMPLIANCE**

This product is declared to conform to the essential requirements of the following directives and carries the CE mark accordingly:

Radio Equipment Directive 2014/53/EU

# 19 Warranty

## Limited One Year Warranty

Autel Intelligent Technology Corp., Ltd. (the Company) warrants to the original retail purchaser of this MaxiCOM diagnostics device that should this product or any part thereof during normal usage and conditions, be proven defective in material or workmanship and results in product failure within 1 year period from the date of purchase, such defect(s) will be repaired, or replaced (with new or rebuilt parts) with Proof of Purchase, at the Company's option, without charge for parts or labor directly related to the defect(s).

---

### NOTE

If the warranty period is inconsistent with local laws and regulations, please comply with the relevant local laws and regulations.

---

The Company shall not be liable for any incidental or consequential damages arising from the use, misuse, or mounting of the device. Some states do not allow limitation on how long an implied warranty lasts, so the above limitations may not apply to you.

### **This warranty does not apply to:**

- 1) Products subjected to abnormal use or conditions, accident, mishandling, neglect, unauthorized alteration, misuse, improper installation or repair or improper storage;
- 2) Products whose mechanical serial number or electronic serial number has been removed, altered or defaced;
- 3) Damage from exposure to excessive temperatures or extreme environmental conditions;
- 4) Damage resulting from connection to, or use of any accessory or other product not approved or authorized by the Company;
- 5) Defects in appearance, cosmetic, decorative or structural items such as framing and non-operative parts;
- 6) Products damaged from external causes such as fire, dirt, sand, battery leakage, blown fuse, theft or improper usage of any electrical source.

---

**!** **IMPORTANT**

All contents of the product may be deleted during the process of repair. You should create a back-up copy of any contents of your product before delivering the product for warranty service.

---

**AUTEL<sup>®</sup>**