

**MaxiSys Elite II Pro**

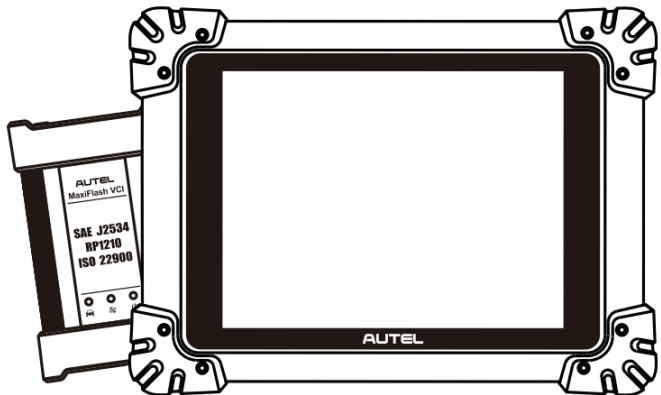

## Trademarks

Autel®, MaxiSys®, MaxiDAS®, MaxiScan®, MaxiTPMS®, MaxiRecorder®, and MaxiCheck® are trademarks of Autel Intelligent Technology Corp., Ltd., registered in China, the United States, and other countries. All other marks are trademarks or registered trademarks of their respective holders.

## Copyright Information

No part of this manual may be reproduced, stored in a retrieval system or transmitted in any form or by any means electronic, mechanical, photocopying, recording, or otherwise without the prior written permission of Autel.

## Disclaimer of Warranties and Limitation of Liabilities

All information, specifications and illustrations in this manual are based on the latest information available at the time of printing.

Autel reserves the right to make changes at any time without notice. While information of this manual has been carefully checked for accuracy, no guarantee is given for the completeness and correctness of the contents, including but not limited to the product specifications, functions, and illustrations.

Autel will not be liable for any direct, special, incidental, or indirect damages, or for any economic consequential damages (including lost profits) as a result of using this product.

---

### IMPORTANT

Before operating or maintaining this unit, please read this manual carefully, paying extra attention to the safety warnings and precautions.

---

## For Services and Support:



[pro.autel.com](http://pro.autel.com)

[www.autel.com](http://www.autel.com)



1-855-288-3587 (North America)

+86 (0755) 8614-7779 (China)



[support@autel.com](mailto:support@autel.com)

For technical assistance in all other markets, please refer to *Technical Support* in this manual.

# Safety Information

---

For your own safety and the safety of others, and to prevent damage to the device and vehicles upon which it is used, it is important that the safety instructions presented throughout this manual be read and understood by all persons operating or coming into contact with the device.

There are numerous procedures, techniques, tools, and parts required for servicing vehicles, as well as the skills of the person doing the work. Because of the vast number of test applications and variations in the products that can be tested with this equipment, we cannot possibly anticipate or provide advice or safety messages to cover every circumstance. It is the automotive technician's responsibility to be knowledgeable of the system being tested. It is crucial to use proper service methods and test procedures. It is essential to perform tests in an appropriate and acceptable manner that does not endanger your safety, the safety of others in the work area, the device being used, or the vehicle being tested.

Before using the device, always refer to and follow the safety messages and applicable test procedures provided by the manufacturer of the vehicle or equipment being tested. Use the device only as described in this manual. Be sure to read, understand, and follow all safety messages and instructions in this manual.

## Safety Messages

Safety messages are provided to help prevent personal injury and equipment damage. All safety messages are introduced by a signal word indicating the hazard level.

---

### **DANGER**

Indicates an imminently hazardous situation which, if not avoided, will result in death or serious injury to the operator or to bystanders.

---

### **WARNING**

Indicates a potentially hazardous situation which, if not avoided, could result in death or serious injury to the operator or to bystanders.

---

## Safety Instructions

---

The safety messages herein cover situations Autel is aware of at the time of publication. Autel cannot know, evaluate or advise you in regards of all possible hazards. You must be certain that any condition or service procedure encountered does not jeopardize your personal safety.

---

 **DANGER**

When an engine is operating, keep the service area WELL VENTILATED or attach a building exhaust removal system to the engine exhaust system. Engines produce carbon monoxide, an odorless, poisonous gas that causes slower reaction time and can lead to serious personal injury or loss of life.

---

 **It is not advised to use headphones at a high volume**

Listening at high volumes for long periods of time may result in loss of hearing.

 **Safety Warnings**

- Always perform automotive testing in a safe environment.
- Wear safety eye protection that meets ANSI standards.
- Keep clothing, hair, hands, tools, test equipment, etc., away from all moving or hot engine parts.
- Operate the vehicle in a well-ventilated work area.
- Put the transmission in PARK (for automatic transmission) or NEUTRAL (for manual transmission) and make sure the parking brake is engaged.
- Put blocks in front of the drive wheels and never leave the vehicle unattended while testing.
- Be extra cautious when working around the ignition coil, distributor cap, ignition wires, and spark plugs. These components create hazardous voltages when the engine is running.
- Keep a fire extinguisher suitable for gasoline, chemical, and electrical fires nearby.
- Do not connect or disconnect any test equipment while the ignition is on or the engine is running.
- Keep the test equipment dry, clean, and free from oil, water, and grease. Use a mild detergent on a clean cloth to clean the outside of the equipment as necessary.
- Do not drive the vehicle and operate the test equipment at the same time. Any distraction may cause an accident.
- Refer to the service manual for the vehicle being serviced and adhere to all diagnostics procedures and precautions. Failure to do so may result in personal injury or damage to the test equipment.
- To avoid damaging the test equipment or generating false data, make sure the vehicle battery is fully charged and the connection to the vehicle DLC is clean and secure.
- Do not place the test equipment on the distributor of the vehicle. Strong electro-magnetic interference can damage the equipment.

# CONTENTS

<b>SAFETY INFORMATION</b> .....	ii
<b>SAFETY INSTRUCTIONS</b> .....	ii
<b>1 USING THIS MANUAL</b> .....	<b>1</b>
1.1 CONVENTIONS .....	1
<b>2 GENERAL INTRODUCTION</b> .....	<b>3</b>
2.1 MAXISYS TABLET.....	3
2.2 MAXIFLASH VCI .....	7
2.3 ACCESSORIES KIT.....	9
<b>3 GETTING STARTED</b> .....	<b>12</b>
3.1 POWER UP.....	12
3.2 POWER DOWN.....	15
<b>4 DIAGNOSTICS</b> .....	<b>17</b>
4.1 ESTABLISH VEHICLE COMMUNICATION AND SELECTION.....	17
4.2 DIAGNOSTICS SCREEN LAYOUT .....	26
4.3 AUTO SCAN.....	29
4.4 CONTROL UNIT .....	31
4.5 ECU INFORMATION .....	33
4.6 TROUBLE CODES .....	33
4.7 LIVE DATA.....	35
4.8 ACTIVE TEST .....	42
4.9 SPECIAL FUNCTIONS .....	43
4.10 PROGRAMMING AND CODING .....	44
4.11 GENERIC OBDII OPERATIONS .....	46
4.12 DIAGNOSTICS REPORT.....	50
4.13 EXIT DIAGNOSTICS .....	54

<b>5</b>	<b>SERVICE</b>	<b>56</b>
5.1	OIL RESET SERVICE	56
5.2	ELECTRIC PARKING BRAKE (EPB) SERVICE	57
5.3	TIRE PRESSURE MONITORING SYSTEM (TPMS) SERVICE	57
5.4	BATTERY MANAGEMENT SYSTEM (BMS) SERVICE	57
5.5	DIESEL PARTICLE FILTER (DPF) SERVICE	58
5.6	STEERING ANGLE SENSOR (SAS) SERVICE	59
<b>6</b>	<b>BATTERY TEST</b>	<b>61</b>
6.1	TEST PREPARATION	61
6.2	IN-VEHICLE TEST	63
6.3	OUT-VEHICLE TEST	68
<b>7</b>	<b>SETTINGS</b>	<b>70</b>
7.1	UNIT	70
7.2	LANGUAGE	70
7.3	PRINTING SETTINGS	71
7.4	REPORT SETTINGS	72
7.5	PUSH NOTIFICATIONS	72
7.6	AUTO UPDATE	73
7.7	VEHICLE LIST	73
7.8	AUTOVID SETUP	73
7.9	SYSTEM SETTINGS	74
7.10	ABOUT	74
<b>8</b>	<b>DATA MANAGER</b>	<b>75</b>
8.1	VEHICLE HISTORY	76
8.2	WORKSHOP INFORMATION	78
8.3	CUSTOMER	79

8.4	IMAGE.....	80
8.5	CLOUD REPORT.....	81
8.6	PDF FILES.....	81
8.7	REVIEW DATA.....	81
8.8	DATA LOGGING.....	82
8.9	UNINSTALL APPS.....	82
<b>9</b>	<b>VCI MANAGER.....</b>	<b>83</b>
9.1	VCI CONNECTION VIA BLUETOOTH.....	83
9.2	BAS CONNECTION VIA BLUETOOTH.....	84
9.3	VCI UPDATE.....	84
9.4	BAS UPDATE.....	85
<b>10</b>	<b>UPDATE.....</b>	<b>86</b>
<b>11</b>	<b>SUPPORT.....</b>	<b>87</b>
11.1	SUPPORT SCREEN LAYOUT.....	87
11.2	MY ACCOUNT.....	87
11.3	TRAINING.....	88
11.4	DATA LOGGING.....	88
11.5	FAQ DATABASE.....	89
<b>12</b>	<b>MAXVIEWER.....</b>	<b>90</b>
<b>13</b>	<b>MAXISCOPE.....</b>	<b>91</b>
<b>14</b>	<b>MAXIVIDEO.....</b>	<b>92</b>
<b>15</b>	<b>QUICK LINK.....</b>	<b>93</b>
<b>16</b>	<b>REMOTE DESKTOP.....</b>	<b>94</b>
16.1	OPERATIONS.....	94
<b>17</b>	<b>USER FEEDBACK.....</b>	<b>96</b>
<b>18</b>	<b>AUTEL USER CENTER.....</b>	<b>97</b>
<b>19</b>	<b>MAINTENANCE AND SERVICE.....</b>	<b>99</b>
19.1	MAINTENANCE INSTRUCTIONS.....	99

19.2	TROUBLESHOOTING CHECKLIST .....	99
19.3	ABOUT BATTERY USAGE .....	100
19.4	SERVICE PROCEDURES .....	101
<b>20</b>	<b>COMPLIANCE INFORMATION .....</b>	<b>104</b>
<b>21</b>	<b>WARRANTY .....</b>	<b>106</b>
21.1	12-MONTH LIMITED WARRANTY .....	106



# 1 Using This Manual

This manual contains device usage instructions.

Some illustrations shown in this manual may make reference to modules and optional equipment that are not included in your system.

## 1.1 Conventions

---

The following conventions are used:

### 1.1.1 Bold Text

Bold text is used to highlight selectable items such as buttons and menu options.

Example:

- Tap **OK**.

### 1.1.2 Notes and Important Messages

#### 1.1.2.1 Notes

A **NOTE** provides helpful information such as additional explanations, tips, and comments.

#### 1.1.2.2 Important

**IMPORTANT** indicates a situation that if not avoided may result in damage to the tablet or vehicle.

### 1.1.3 Hyperlinks

Hyperlinks are available in electronic documents. Blue text indicates a selectable hyperlink, a website link or an email address link.

### 1.1.4 Illustrations

Illustrations used in this manual are samples, and the actual testing screen may vary for each vehicle being tested. Observe the menu titles and on-screen instructions to make correct option selection.

### 1.1.5 Procedures

An arrow icon indicates a procedure.

Example:

- **To power down the MaxiSys tablet**
  1. Press and hold the **Power/Lock** button.
  2. Tap **Power Off**.
  3. Tap **OK**.

# 2 General Introduction

There are two main components to the MaxiSys Elite II Pro system:

- MaxiSys Tablet — the central processor and monitor for the system.
- MaxiFlash VCI — Vehicle Communication Interface.

This manual describes the construction and operation of these devices and how they work together to deliver diagnostic solutions.

## 2.1 MaxiSys Tablet

---

### 2.1.1 Functional Description

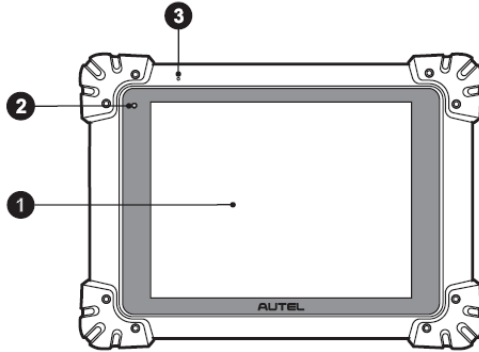

**Figure 2-1** *MaxiSys Tablet, Front View*

1. 9.7" LED Capacitive Touchscreen
2. Ambient Light Sensor — detects ambient light brightness
3. Microphone

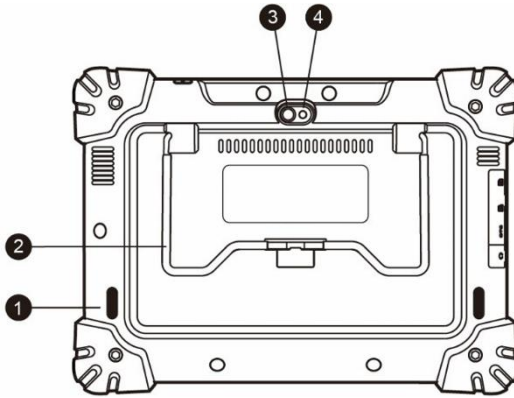

**Figure 2-2 MaxiSys Tablet, Back View**

1. Speaker
2. Collapsible Stand — extends from the back to allow hands-free viewing of the tablet
3. Rear Camera
4. Camera Flash

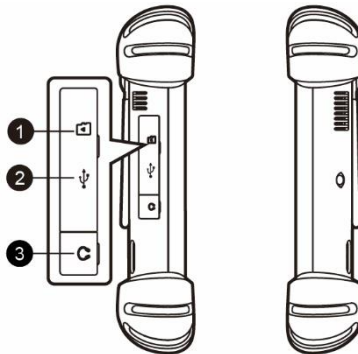

**Figure 2-3 MaxiSys Tablet, Side Views**

1. Mini SD (Secure Digital) Card Slot
2. Mini USB (Universal Serial Bus) Port
3. Headphone Jack

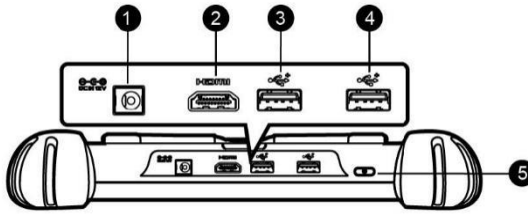

**Figure 2-4 MaxiSys Tablet, Top View**

1. DC Power Supply Input Port
2. HDMI (High-definition Multimedia Interface) Port
3. USB Port
4. USB Port
5. Power/Lock Button — long press to turn the tablet on and off, or short press to lock the screen

## 2.1.2 Power Sources

The tablet can receive power from any of the following sources:

- Internal battery pack
- AC/DC power supply
- Vehicle power

---

### ! IMPORTANT

Do not charge the battery when the temperature is below 0°C (32°F) or above 45°C (113°F).

---

#### 2.1.2.1 Internal Battery Pack

The tablet can be powered with its internal rechargeable battery, which if fully charged can provide sufficient power for about 7.5 hours of continuous operation.

#### 2.1.2.2 AC/DC Power Supply

The tablet can be powered from an electrical outlet using the AC/DC power adapter. The AC/DC power supply also charges the internal battery pack.

#### 2.1.2.3 Vehicle Power

The tablet can be powered from the auxiliary power outlet adapter or other DC power port on the test vehicle through a direct cable connection. The vehicle power cable connects to the DC power supply port on the top side of the tablet.

## 2.1.3 Technical Specifications

**Table 2-1 Tablet Specifications**

Item	Description
<b>Operating System</b>	Android 10.0
<b>Processor</b>	Octa-core processor (2.2 GHz quad-core + 1.8 GHz quad-core)
<b>Memory</b>	4 GB RAM & 128 GB on-board memory
<b>Display</b>	9.7" HD display with 2048 × 1536 resolution & capacitive touchscreen
<b>Connectivity</b>	<ul style="list-style-type: none"> <li>● Wi-Fi 802.11 a/b/g/n/ac</li> <li>● Bluetooth V5.0 + EDR</li> <li>● USB 2.0</li> <li>● HDMI</li> <li>● SD Card (Support up to 64 GB)</li> </ul>
<b>Camera</b>	<ul style="list-style-type: none"> <li>● Rear: 16.0 megapixel</li> <li>● Autofocus with flashlight</li> </ul>
<b>Sensors</b>	<ul style="list-style-type: none"> <li>● Gravity accelerometer</li> <li>● Ambient Light Sensor (ALS)</li> </ul>
<b>Audio Input / Output</b>	<ul style="list-style-type: none"> <li>● Microphone</li> <li>● Dual speakers</li> <li>● 3-band 3.5 mm stereo/standard headset jack</li> </ul>
<b>Power and Battery</b>	<ul style="list-style-type: none"> <li>● 3.7 V/11000 mAh Lithium-polymer battery</li> <li>● Charging via 12 V AC/DC power supply with a temperature between 0 °C and 45 °C</li> </ul>
<b>Input Voltage</b>	12 V (9 to 24 V)
<b>Power Consumption</b>	6.5 W
<b>Operating Temp.</b>	0 to 50 °C (32 to 122 °F)
<b>Storage Temp.</b>	-10 to 60 °C (14 to 140 °F)
<b>Dimensions (W x H x D)</b>	300 mm (11.81") x 220 mm (8.66") x 50 mm (1.97")
<b>Weight</b>	1.42 kg (3.13 lbs.)

Item	Description
Protocols	ISO 9142-2, ISO 14230-2, ISO 15765-4, K/L-Line, Flashing Code, SAE-J1850 VPW, SAE-J1850 PWM, CAN ISO 11898, Highspeed, Middlespeed, Lowspeed and Singlewire CAN, GM UART, UART Echo Byte Protocol, Honda Diag-H Protocol, TP 2.0, TP 1.6, SAE J1939, SAE J1708, Fault-Tolerant CAN, ISO 13400, CAN FD

## 2.2 MaxiFlash VCI

### 2.2.1 Function Descriptions

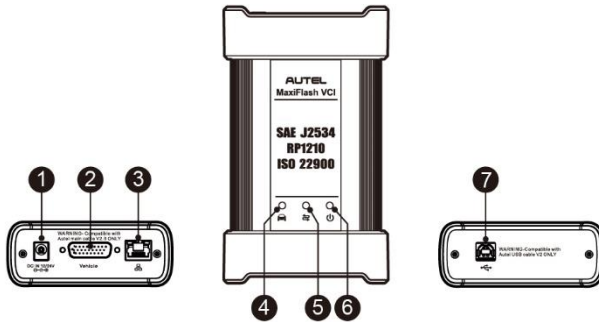

Figure 2-5 MaxiFlash VCI Views

1. DC Power Supply Input Port
2. Vehicle Data Connector
3. Ethernet Port
4. Vehicle LED
  - Flashes green when communicating with the vehicle system
5. Connection LED
  - Lights solid green when connected with the tablet via the USB cable
  - Lights solid blue when connected via Bluetooth (BT)
6. Power LED
  - Lights solid yellow automatically at power-up when VCI is self-testing
  - Lights solid green when powered on
  - Lights solid red when system failure has occurred

- Flashes red when VCI is upgrading

## 7. USB Port

### 2.2.1.1 *Programming Capability*

The MaxiFlash VCI is a D-PDU, SAE J2534 & RP1210 compliant PassThru programming interface device. Using the updated OEM software, it is capable of replacing the existing software/firmware in the Electronic Control Units (ECU), programming new ECUs, and fixing software-controlled drivability issues and emission issues.

---

### **!** IMPORTANT

DO NOT disconnect the MaxiFlash VCI while the vehicle LED is on. If the reprogramming procedure is interrupted while the vehicle's ECU is blank or only partially programmed, the module may be unrecoverable.

---

### 2.2.1.2 *Communication Capability*

The MaxiFlash VCI supports Bluetooth and USB communication methods. It can transmit vehicle data to the tablet with or without a cable connection. In open areas, the working range of the transmitter through Bluetooth communication is up to 328 feet (about 100 m). If the signal is lost due to being taken out of range, communication will be restored once the tablet is within range.

## 2.2.2 Power Sources

The VCI can receive power from the following sources:

- Vehicle power
- AC/DC power supply

### 2.2.2.1 *Vehicle Power*

The MaxiFlash VCI operates on 12/24 volt vehicle power, which receives power via the vehicle data connection port. The device powers on whenever it is connected to an OBDII/EOBD compliant Data Link Connector (DLC). For non-OBDII/EOBD compliant vehicles, the device can be powered from an auxiliary power outlet adapter or other suitable power port on the test vehicle using the auxiliary power cable.

### 2.2.2.2 *AC/DC Power Supply*

The MaxiFlash VCI can be powered from a wall socket using the AC/DC power adapter.

## 2.2.3 Technical Specifications



**Table 2-2 MaxiFlash VCI Specifications**

Item	Description
<b>Communications</b>	<ul style="list-style-type: none"><li>● Bluetooth V5.0 + EDR</li><li>● USB 2.0</li><li>● Ethernet</li></ul>
<b>Input Voltage Range</b>	DC 9 to 28 V
<b>Supply Current</b>	<ul style="list-style-type: none"><li>● 190 mA @ 12 V</li><li>● 110 mA @ 24 V</li></ul>
<b>Operating Temp.</b>	0 to 50 °C (32 to 122 °F)
<b>Storage Temp.</b>	-20 to 60 °C (-4 to 140 °F)
<b>Dimensions (L x W x H)</b>	149 mm (5.87") x 86 mm (3.38") x 35 mm (1.28")
<b>Weight</b>	0.29 kg (0.64 lb.)

## 2.3 Accessories Kit

---

### 2.3.1 Main Cable V2.0

The MaxiFlash VCI can be powered through the Autel Main Cable V2.0 (the V2.0 icon can be seen on the cable) when connected to an OBDII/EOBD compliant vehicle. The Main Cable V2.0 connects the VCI to the vehicle's DLC, through which the VCI can transmit vehicle data to the tablet.

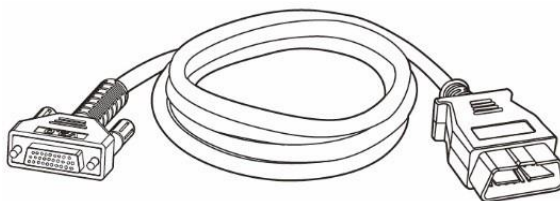

**Figure 2-6 Main Cable — 1.5m in Length**

---

#### **NOTE**

The MaxiFlash VCI can be connected by the Autel Main Cable V2.0 only. DO NOT use other Autel main cables to connect the MaxiFlash VCI.

---

### 2.3.2 OBDI Adapters (Optional)

The optional OBDI-type adapters are for non-OBDII vehicles. The adapter used depends on the type of vehicle being tested. The adapters are sold separately. Please contact your distributor for detail.



Benz-14



Chrysler-16



BMW-20



Nissan-14



Kia-20



Fiat-3



PSA-2

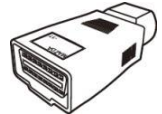

Mazda-17



Volkswagen/  
Audi-2+2



Benz-38



Mitsubishi/  
Hyundai-12+16

### 2.3.3 Accessories



**Autel USB Cable V2 (the V2 icon can be seen on the cable)**

Connects the tablet to the VCI unit.



**Mini USB Cable**

Connects the tablet to the computer.

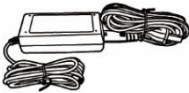

**AC/DC External Power Adapter**

Connects the tablet to the external DC power port for power supply.



**Auxiliary Power Outlet Adapter**

Provides power to the tablet or the VCI through connection to the vehicle's auxiliary power outlet, as some non-OBDII vehicles cannot provide power via the DLC connection.



### **Clamp Cable**

Supplies power to the tablet or the VCI through connection to the vehicle battery.

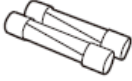

### **Light Fuse x2**

A safety device for the auxiliary power outlet adapter.

# 3 Getting Started

Make sure the tablet has sufficient power or is connected to an external power supply (see [Power Sources](#)).

**NOTE**

The images and illustrations depicted in this manual may differ from the actual ones.

## 3.1 Power Up

Long press the **Power/Lock** button on the top-right side of the tablet to switch the unit on. The system boots up and shows the lock screen. Slide up to unlock and enter the MaxiSys Job Menu screen.



**Figure 3-1 MaxiSys Job Menu Screen**

1. Application Buttons
2. Page Control and Navigation Menu
3. Status Icons

**NOTE**











We recommend that you lock the screen when not in use to protect private information in the system and conserve power.





Almost all operations on the tablet are controlled through the touchscreen. The touchscreen navigation is menu-driven, which allows you to quickly locate the test procedure or data that you need, through a series of questions and options. Detailed descriptions of the menu structures can be found in the chapters for each application.

### 3.1.1 Application Buttons

The table below briefly describes each of the applications in the MaxiSys system.

**Table 3-1 Applications**







Button	Name	Description
	<b>Diagnostics</b>	Accesses the unit's diagnostics functions. See <a href="#">Diagnostics</a> .
	<b>Service</b>	Accesses special functions menu. See <a href="#">Service</a> .
	<b>Battery Test</b>	Accesses the Battery Test menu with in-vehicle test and out-vehicle test functions. See <a href="#">Battery Test</a> .
	<b>Settings</b>	Accesses the system settings menu. See <a href="#">Settings</a> .
	<b>Data Manager</b>	Accesses the saved repair shop, customer and vehicle data including detailed vehicle diagnostics and test records. See <a href="#">Data Manager</a> .
	<b>VCI Manager</b>	Accesses the VCI connection menu. See <a href="#">VCI Manager</a> .
	<b>Update</b>	Accesses system software update menu. See <a href="#">Update</a> .
	<b>Support</b>	Synchronizes Autel's online service database with the MaxiSys tablet. See <a href="#">Support</a> .
	<b>MaxiViewer</b>	Provides a quick search for supported functions and/or vehicles. See <a href="#">MaxiViewer</a> .
	<b>MaxiScope</b>	Configures the MaxiSys diagnostic device to operate as an automotive oscilloscope when work in combination with the MaxiScope module. See <a href="#">MaxiScope</a> .





Button	Name	Description
	<b>MaxiVideo</b>	Configures the unit to operate as a video scope device by connecting to an imager head cable for close vehicle inspections. See <a href="#">MaxiVideo</a> .
	<b>Quick Link</b>	Provides associated website bookmarks to allow quick access to product update, service, support, and other information. See <a href="#">Quick Link</a> .
	<b>Remote Desktop</b>	Configures your unit to receive remote support using the TeamViewer application. See <a href="#">Remote Desktop</a> .
	<b>User Feedback</b>	Allows you to submit questions related to this product. See <a href="#">User Feedback</a> .
	<b>Autel User Center</b>	Allows you to register an Autel account, view and edit your personal profile, and link your device. See <a href="#">Autel User Center</a> .

### 3.1.2 Locator and Navigation Buttons

Operations of the Navigation buttons at the bottom of the screen are described in the table below:

**Table 3-2 Locator and Navigation Buttons**

Button	Name	Description
	<b>Locator</b>	Indicates the location of the screen. Swipe the screen left or right to view the previous or next screen.
	<b>Back</b>	Returns to the previous screen.
	<b>MaxiSys Home</b>	Returns to the MaxiSys Job Menu.
	<b>Android Home</b>	Returns to the Android system home screen.
	<b>Recent Apps</b>	Displays a list of applications that are currently running. Tap an app icon to launch. Remove an app by swiping it to the left or right.
	<b>Browser</b>	Launches the Chrome Internet browser.

Button	Name	Description
	Camera	Launches the camera. Press and hold to capture a screenshot of the current screen. Saved files are stored in the Data Manager application for later review. See <a href="#">Data Manager</a> .
	Display & Sound	Adjusts the brightness of the screen and the volume of the audio output.
	VCI	Opens the VCI Manager application. A green badge with a BT or USB icon at the bottom-right corner indicates the VCI is connected, while a red “x” icon will be displayed if the connection fails.
	MaxiSys Shortcut	Returns to the Diagnostics screen.
	Service Shortcut	Returns to the Service screen.

➤ **To use the camera**

1. Tap the **Camera** icon. The camera screen opens.
2. Focus the image to be captured in the viewfinder.
3. Tap the camera icon on the right side of the screen. The viewfinder now shows the captured picture and auto-saves the taken photo.
4. Swipe the screen left to view the stored photos.
5. Tap the **Back** or **Home** button to exit the camera application.

 **NOTE**

After swiping the camera screen from left to right, the camera mode and video mode can be switched by tapping the blue camera icon or video icon.

### 3.1.3 System Status Icons

Your MaxiSys tablet is a fully functional Android tablet with the standard Android operation system status icons. Refer to Android documentation for additional information.

## 3.2 Power Down

All vehicle communications should be terminated before shutting down the tablet. A warning message displays if a shutdown is attempted while the tablet is communicating with the vehicle. Forcing a shutdown while the tablet is communicating with the vehicle

may lead to ECU problems on some vehicles. Please exit the Diagnostics application before shutting off the tablet.

➤ **To power down the MaxiSys tablet**

1. Press and hold the **Power/Lock** button.
2. Tap **Power Off**.
3. Tap **OK**.

### **3.2.1 Reboot System**

In case of a system crash, press and hold the **Power/Lock** button and tap **Restart** to reboot the system.



# 4 Diagnostics

The Diagnostics application can access the electronic control module of multiple vehicle control systems, including but not limited to the engine, transmission, anti-lock brake system (ABS), and airbag system (SRS).

## 4.1 Establish Vehicle Communication and Selection

---

### 4.1.1 Establish Vehicle Communication

The Diagnostics operations require connecting the MaxiSys Elite II Pro tablet to the test vehicle through the MaxiFlash VCI using the Main Cable V2.0 (Use the applicable OBDI adapter if needed). To establish proper vehicle communication with the tablet, you need to perform the following steps:

1. Connect the VCI to the vehicle's DLC for both communication and power source.
2. Connect the VCI to the tablet via Bluetooth or USB connection.
3. Check the VCI navigation button at the bottom bar on the screen. If a green BT or USB icon appears at the lower-right corner, the MaxiSys Diagnostics Platform is ready to start vehicle diagnosis.

#### 4.1.1.1 Vehicle Connection

The method used to connect the VCI to a vehicle's DLC depends on the vehicle's configuration as follows:

- A vehicle equipped with an On-board Diagnostics Two (OBDII) management system supplies both communication and 12-volt power through a standardized J-1962 DLC.
- A vehicle not equipped with an OBDII management system supplies communication through a DLC connection, and in some cases supplies 12-volt power through the auxiliary power outlet or a connection to the vehicle battery.

#### **OBDII Vehicle Connection**

This type of connection only requires the Main Cable V2.0 without any additional adapter.

##### ➤ **To connect to an OBDII vehicle**

1. Connect the main cable's female adapter to the Vehicle Data Connector on the VCI and tighten the captive screws.
2. Connect the cable's 16-pin male adapter to the vehicle's DLC, which is generally

located under the vehicle dashboard.

---

**NOTE**

The vehicle's DLC is not always located under the dashboard. Refer to the user manual of the test vehicle for additional connection information.

---

**Non-OBDII Vehicle Connection**

This type of connection requires both the Main Cable V2.0 and an OBDI adapter for the specific vehicle being serviced.

There are three possible scenarios for non-OBDII vehicle connection:

- DLC connection supplies both communication and power.
- DLC connection supplies communication and power is supplied via the auxiliary power outlet.
- DLC connection supplies communication and power is supplied via the vehicle battery.

➤ **To connect to a non-OBDII Vehicle**

1. Connect the main cable's female adapter to the Vehicle Data Connector on the VCI and tighten the captive screws.
  2. Locate the required OBDI adapter and connect its 16-pin jack to the main cable's male adapter.
  3. Connect the attached OBDI adapter to the vehicle's DLC.
- 

**NOTE**

Some vehicles may have more than one adapter or may have test leads instead of an adapter. Make the proper connection to the vehicle DLC as required.

---

➤ **To connect the auxiliary power outlet adapter**

1. Plug the DC power connector of the auxiliary power outlet adapter into the DC power supply input port on the device.
2. Connect the male connector of the auxiliary power outlet adapter into the vehicle's auxiliary power outlet.

➤ **To connect the clipper cable**

1. Connect the tubular plug of the clipper cable to the male connector of the auxiliary power outlet adapter.

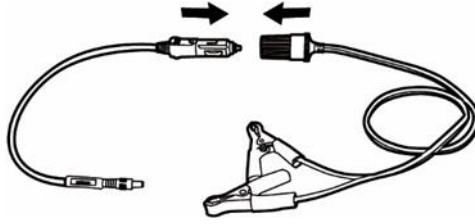

**Figure 4-1 Connection between Auxiliary Power Outlet Adapter and Clipper Cable**

2. Plug the DC power connector of the auxiliary power outlet adapter into the DC power supply input port of the VCI.
3. Connect the clipper cable to the vehicle's battery.

**NOTE**

After the VCI is successfully connected to the vehicle, the Power LED on the device lights solid green and a beeping sound will be heard.

#### 4.1.1.2 VCI Connection

After the VCI is properly connected to the vehicle, the Power LED on the VCI lights solid green, and is ready to establish communication with the tablet.

The VCI supports two communication methods with the tablet: Bluetooth and USB.

#### Pairing via Bluetooth

In open areas, the working range for Bluetooth communication is about 328 feet (100 m), giving technicians greater mobility to perform vehicle diagnosis from anywhere in the repair shop.

To expedite multi-vehicle diagnostics, more than one VCI can be used in busy repair shops, enabling technicians to quickly pair their MaxiSys tablet to each VCI separately via Bluetooth and therefore eliminating the need to unplug the VCI from one vehicle and then connect it to another each time.

#### ➤ To pair the tablet with the VCI via Bluetooth

1. Power up the tablet.
2. Select the **VCI Manager** application from the MaxiSys Job Menu.
3. Select **VCI BT** from the connection mode list. Tap the Bluetooth toggle to turn it **ON**. The device automatically scans for available VCIs for pairing. The found devices are listed on the right side of the screen.

---

**NOTE**

If no VCI is found, this may indicate that the signal strength is too weak to be detected. Reposition the VCI and remove all possible objects that may cause signal interference. Tap the **Scan** button at the top-right corner to rescan for the VCI.

---

4. Typically, the VCI name appears as “Maxi” suffixed with a serial number. Select the VCI for pairing. (If more than one VCI is used in the shop, ensure the correct VCI is selected for pairing.)
5. When pairing is successful, the connection status reads, “Connected.”
6. The VCI icon on the tablet navigation bar on the bottom appears as a green circle badge with a BT icon when the tablet and the VCI are connected.

### **USB Cable Connection**

The USB cable connection is a simple and quick way to establish communication between the tablet and the VCI. After properly connecting the tablet to the VCI using the USB cable, the VCI navigation button at the bottom bar of the screen displays a green circle badge with a USB icon and the connection LED on the VCI lights solid green, indicating the connection between the devices is successful.

---

**NOTE**

The USB connection provides the most stable communication and is therefore the recommended communication method between the tablet and VCI when operating ECU programming or coding.

---

The MaxiSys diagnostic platform is now ready to perform vehicle diagnosis.

#### **4.1.1.3 No Communication Message**

- A.** If the tablet is unable to connect to the VCI, an error message appears. An error message indicates the tablet is not communicating with the VCI. Troubleshoot the error by performing the following steps:
- Ensure the VCI is powered on.
  - When using the wireless connection, ensure the network is configured correctly and the proper device has been connected.
  - If the tablet loses communication abruptly during the diagnosis, ensure no objects are causing signal interference.
  - Ensure the VCI is properly positioned with the VCI front side up.
  - Move the tablet closer to the VCI. If using the wired connection, ensure the cable is securely attached to the VCI.
  - Ensure the connection LED is lit for the selected communication type: Bluetooth

or USB.

**B.** If the VCI is unable to establish a communication link, a message will display. Possible causes for the communication error include:

- A vehicle system has been selected for diagnosis that is not supported by the vehicle.
- There is a loose connection.
- There is a blown vehicle fuse.
- The vehicle or the data cable has a wiring fault.
- There is a circuit fault in the data cable or adapter.
- The vehicle information entered is incorrect.

## 4.1.2 Getting Started

Prior to first use of the Diagnostics application, ensure the VCI is properly connected to and is communicating with the tablet. See [VCI Connection](#).

### 4.1.2.1 Vehicle Menu Layout

When the VCI is properly connected to the vehicle and the tablet, the platform is ready to start vehicle diagnosis. Tap the **Diagnostics** application button on the MaxiSys Job Menu, the Vehicle Menu will appear on the screen.

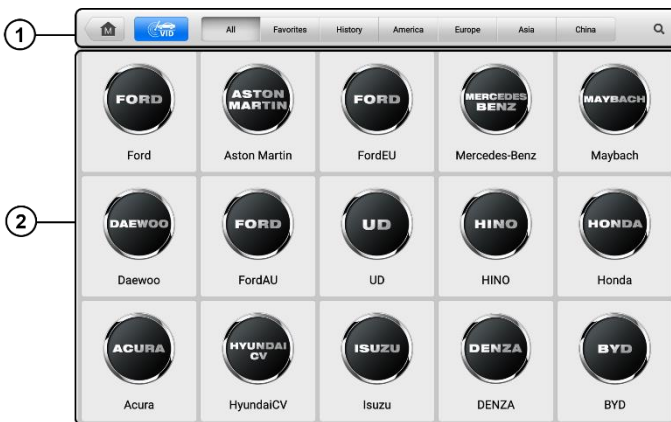



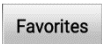
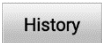





**Figure 4-2 Vehicle Menu Screen**

1. Top Toolbar Buttons
2. Automobile Manufacturer Buttons

## Top toolbar Buttons

The operations of the Toolbar buttons at the top of the screen are listed and described in the table below:

**Table 4-1 Top Toolbar Buttons**

Button	Name	Description
	<b>Home</b>	Returns to the MaxiSys Job Menu.
	<b>VID</b>	<p>Opens a dropdown list.</p> <ul style="list-style-type: none"> <li>● Tap <b>Auto Detect</b> for auto VIN detection.</li> <li>● Tap <b>Manual Input</b> to enter a VIN code or license number manually.</li> <li>● Tap <b>Scan VIN/License</b> to scan the VIN code/license number using the built-in camera.</li> </ul>
	<b>All</b>	Displays all the vehicle makes in the vehicle menu.
	<b>Favorites</b>	Displays user-selected favorite vehicle makes.
	<b>History</b>	Displays your saved vehicle historical records. This option provides direct access to previously tested vehicle records. See <a href="#">Vehicle History</a> .
	<b>America</b>	Displays the American vehicle menu.
	<b>Europe</b>	Displays the European vehicle menu.
	<b>Asia</b>	Displays the Asian vehicle menu.
	<b>China</b>	Displays the Chinese vehicle menu.
	<b>Search</b>	Tap to open a virtual keyboard and manually enter a specific vehicle make.
	<b>Cancel</b>	Tap to exit the search screen or cancel an operation.

## Automobile Manufacturer Buttons

The Automobile Manufacturer buttons display the various vehicle brands. Select an automobile manufacturer button after the VCI is properly connected to the test vehicle to start a diagnostics session.

## 4.1.3 Vehicle Identification

The MaxiSys diagnostics system supports five methods of Vehicle Identification.

1. Auto Detect
2. Manual Input
3. Scan VIN/License
4. Manual Vehicle Selection
5. Alternative Vehicle Identification

### 4.1.3.1 Auto Detect

The MaxiSys diagnostics system features the latest VIN-based Auto VIN Scan function to identify test vehicles with just one tap, enabling the technician to quickly identify the exact vehicle and scan its available systems for fault codes.

#### ➤ To perform an AutoVIN Scan

1. Tap the **Diagnostics** application button from the MaxiSys Job Menu. The Vehicle Menu appears.
2. Tap the **VID** button on the top toolbar.
3. Select **Auto Detect**. The tablet starts VIN scanning on the vehicle's ECU. Once the test vehicle is successfully identified, the system will guide you to the Vehicle Diagnostics screen.

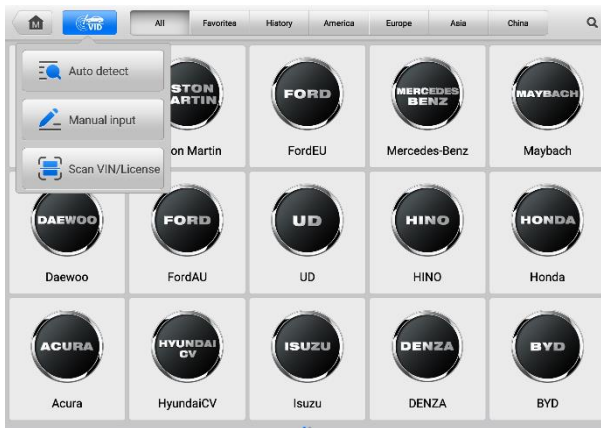

**Figure 4-3 Auto Detect Screen**

In some cases, the Auto VIN function is still available for some vehicle makes after being selected.

Select an automobile manufacturer icon from the Vehicle Menu screen (Figure 4-2) and then tap **Automatic Selection > Read**. The system will proceed to acquire VIN information automatically or allow users to manually enter the VIN.



**Figure 4-4 Automatic Selection Screen**

#### 4.1.3.2 Manual Input

For some vehicles that do not support the Auto VIN Scan function, the MaxiSys Diagnostics system allows you to manually enter the vehicle VIN or license number, or simply take a photo of the VIN sticker or license plate for quick vehicle identification.

➤ **To perform Manual Input**

1. Tap the **Diagnostics** application button from the MaxiSys Job Menu. The Vehicle Menu displays.
2. Tap the **VID** button on the top toolbar.
3. Select **Manual Input** in the dropdown list.
4. Tap the input box and enter the correct VIN code or license number.
5. Tap **OK**. The vehicle will be identified and matched to the vehicle database and the Vehicle Diagnostics screen will appear.
6. Tap the  icon on the top-right corner to exit Manual Input.

#### 4.1.3.3 Scan VIN/License

➤ **To perform Scan VIN/License**

1. Tap the **Diagnostics** application button from the MaxiSys Job Menu. The Vehicle Menu displays.
2. Tap the **VID** button on the top toolbar.



3. Tap **Scan VIN/License** in the dropdown list (*Figure 4-3*). The camera will launch. On the right side of the screen, from top to bottom, three options are available: Scan Bar Code, Scan VIN, and Scan License.

---

**NOTE**

The Scan License option is supported in certain countries and areas. If not available, manually enter the license number.

---

4. Select one of the three options and position the tablet to align the VIN or license number within the scanning window, the result appears in the Recognition Result dialog box after being scanned. Tap **OK** to confirm the result, and then the vehicle information confirmation screen will appear on the tablet. If all the vehicle information is correct, tap the icon on the middle of the screen to confirm the VIN of the vehicle being tested. Tap **OK** to continue.

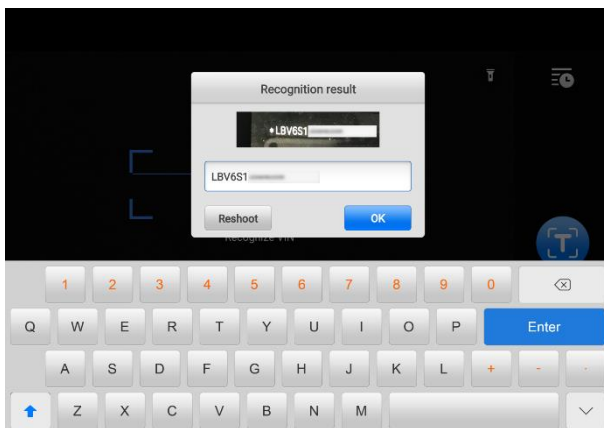

**Figure 4-5 Scan VIN Code Screen**

5. If the VIN/License number cannot be scanned, please manually enter it. Tap **OK** to continue. Manually enter the license number and select a vehicle brand in the vehicle information confirmation screen. Tap the icon on the middle of the screen to confirm the VIN of the vehicle being tested. Tap **OK** to continue.

#### 4.1.3.4 Manual Vehicle Selection

When the vehicle's VIN is not automatically retrievable through the vehicle's ECU, or when the specific VIN is unknown, you can manually select the vehicle.

This mode of vehicle selection is menu-driven. Select the manufacturer icon on the Vehicle Menu screen and the Select Diagnostic Type screen appears. Tap the **Manual Selection** button. Select the vehicle information (e.g., the series, model, engine, type, and emission) on the same screen. Tap **Reset** or **ESC** to reselect the vehicle information, if needed.

### 4.1.3.5 Alternative Vehicle Identification

Occasionally, the tablet may not be able to identify a vehicle. For these vehicles, the user may perform a generic OBDII or EOBD diagnostics. See [Generic OBDII Operations](#) for additional information.

## 4.2 Diagnostics Screen Layout

After the vehicle information is selected, tap the **OK** button at the bottom-right corner of the screen to open the Main Menu screen. This section consists of various functions commonly used, including Auto Scan and Control Unit. The available functions displayed vary by vehicle.

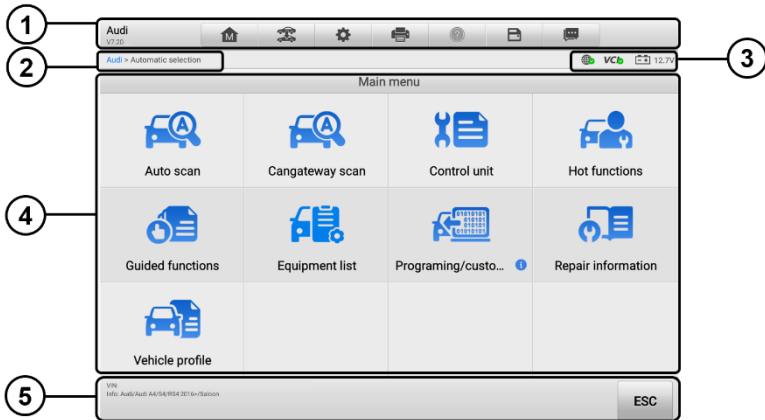







**Figure 4-6 Main Menu Screen**

1. Diagnostics Toolbar
2. Current Directory Path
3. Status Information Bar
4. Main Section
5. Function Buttons

### *Diagnostics Toolbar*

The Diagnostics Toolbar contains buttons that allow you to print or save the displayed data and perform other operations. The table 4-2 provides a brief description for the operations of the diagnostics toolbar buttons.

**Table 4-2 Diagnostics Toolbar Buttons**

Button	Name	Description
	<b>Home</b>	Returns to the MaxiSys Job Menu.
	<b>Vehicle Swap</b>	Exits the diagnostics session and returns to the vehicle menu screen to select another vehicle for testing.
	<b>Settings</b>	Opens the Settings screen. See <a href="#">Settings</a> .
	<b>Print</b>	Saves and prints a copy of the displayed data. See <a href="#">Printing Settings</a> .
	<b>Help</b>	Provides instructions or tips for operations of various diagnostics functions.
	<b>Save</b>	Opens a submenu which provides options for data storage.
	<b>Data Logging</b>	Use this function when encountering an error during test or diagnosis. This function will record the communication data and ECU information of the test vehicle and send it to Autel technical staff to review and provide a solution.  Go to the Support application to view the processing progress. See <a href="#">Data Logging</a> .

**NOTE**

The Diagnostics Toolbar buttons (located on the top of the screen) will be active throughout the diagnostics session for such tasks as printing and saving the displayed data, obtaining help information or performing data logging.

➤ **To print data in Diagnostics**

1. Tap the **Diagnostics** application button on the MaxiSys Job Menu. The **Print** button on the diagnostics toolbar is available throughout the Diagnostics operations.
2. Tap **Print** and a drop-down menu displays.
  - a) Print This Page — prints a screenshot of the current screen.
  - b) Print All Data — prints a PDF copy of all displayed data.
3. A temporary file will be created and sent via the computer to the printer.
4. When the file is sent, a confirmation message appears.

---

**NOTE**

Make sure the tablet and the printer are connected either by Wi-Fi or LAN before printing. For more instructions on printing, see [Printing Settings](#) for details.

---

➤ **To submit Data Logging reports in Diagnostics**

1. Tap the **Diagnostics** application button from the MaxiSys Job Menu. The **Data Logging** button on the diagnostics toolbar is available throughout the Diagnostics operations.
2. Tap the **Data Logging** button to display the error options. Select a specific error, and a submission form will appear to let you fill in the report information.
3. Tap the **Send** button in the upper-right corner of the screen to submit the report form via the Internet. A confirmation message appears when sent successfully.

### *Current Directory Path*

The Directory Path shows all directory names to access the current screen.

### *Status Information Bar*

The Status Information Bar at the top of the Main Section displays the following items:

1. Network Icon — indicates whether a network is connected.
2. VCI Icon — indicates the communication status between the tablet and VCI.
3. Battery Icon — indicates the battery status of the vehicle.

### *Main Section*

The Main Section of the screen varies depending on the stage of operations. The Main Section can show vehicle identification selections, the main menu, test data, messages, instructions, and other diagnostics information.

### *Function Buttons*

The Function Buttons vary depending on the stage of operations. They can be used to navigate, save or clear the diagnostic data, exit scanning as well as make other controls. The functions of these buttons will be described in the following sections when relevant.

## **4.2.1 Screen Messages**

Messages appear when additional input is needed before proceeding. There are three main types of on-screen messages: Confirmation, Warning, and Error.

### ❖ **Confirmation Messages**

These usually appear as an "Information" screen, when you are about to perform an action that cannot be reversed or when an action has been initiated and your confirmation is needed to continue.

When a user-response is not required, the message only appears briefly.

### ❖ **Warning Messages**

These appear when completing the selected action may result in an irreversible change or loss of data. An example of this message is the "Erase Codes" message.

### ❖ **Error Messages**

These appear when a systemic or procedural error has occurred. Possible errors include cable disconnection and communication interruption.

## 4.2.2 Making Selections

The Diagnostics application is a menu-driven program that presents a series of options. As you select from a menu, the next menu in the series appears. Each selection narrows the focus and leads to the desired test.

## 4.3 Auto Scan

---

The Auto Scan function performs a comprehensive scanning of all the systems in the vehicle ECU to locate faults and retrieve DTCs. Tap **Fault Scan** at the bottom of the screen to start.

### ➤ **To perform the Auto Scan function**

1. Tap the **Diagnostics** application button on the MaxiSys Job Menu. Choose the corresponding vehicle information and enter the Main Menu screen.
2. Select **Auto Scan** on the Main Menu to enter the diagnostics interface.
3. Tap the **Fault Scan** button at the bottom of the screen to scan the vehicle system modules.

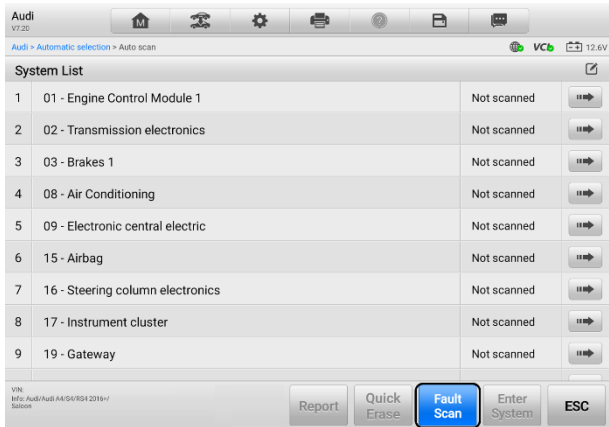

**Figure 4-7 Auto Scan Screen**

**NOTE**

On the Auto Scan screen, there is a **Select System** icon  on the upper-right corner. Select the corresponding system(s) to scan will save more time than scanning all systems.

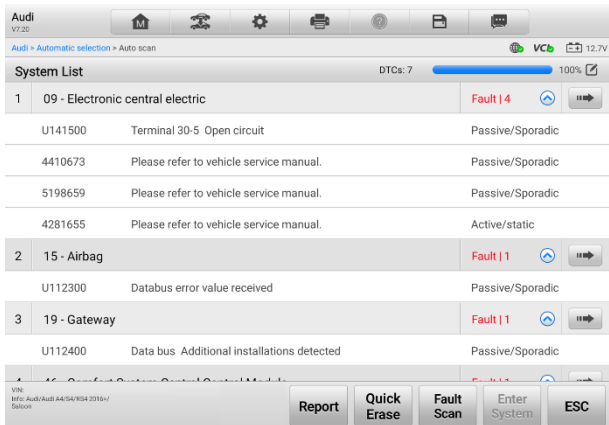

**Figure 4-8 Auto Scan Results Screen**

- The results are displayed on the screen. The quantity of total faults will appear on the upper-right corner.

Column 1 — displays the system numbers.

Column 2 — displays the scanned systems.

Column 3 — displays the scan results.

- ❖ **Fault | #:** Indicates there is/are fault code(s) detected; “#” indicates the quantity of detected faults.
- ❖ **Pass | No Fault:** Indicates the system was scanned and no faults has been detected.
- ❖ **Not Scanned:** Indicates the system has not been scanned.
- ❖ **No Response:** Indicates the system has not received a response.

Column 4 — tap to enter the corresponding system.

The table 4-3 provides a brief description of how the function buttons in Auto Scan operate:

**Table 4-3 Function Buttons in Auto Scan**

<b>Name</b>	<b>Description</b>
<b>Report</b>	Displays the diagnostic data in the report form.
<b>Quick Erase</b>	Erases all faults after scanning.
<b>Fault Scan</b>	Scans vehicle system modules.
<b>Pause</b>	Pauses the scanning process.
<b>Enter System</b>	Enters the ECU system.
<b>ESC</b>	Returns to the previous screen or exits the Diagnostics Screen.

Select one of the system modules from System List screen and tap **Enter System** to enter the specific system functions.

## 4.4 Control Unit

---

The Control Unit function allows you to manually locate a required control system for testing through a series of choices. Follow the menu-driven procedure, the program will guide you to the Function Menu screen.

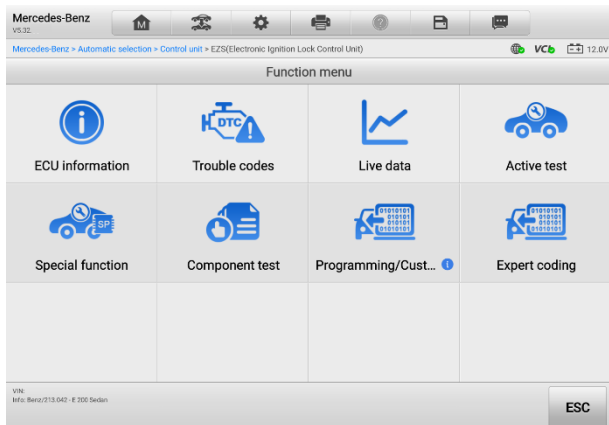

**Figure 4-9 Function Menu Screen**

Available functions may vary by vehicle. The function menu may include:

- **ECU Information** — displays detailed ECU information. Select to display information screen.
- **Trouble Codes** — contains Read Codes and Erase Codes. The former displays detailed DTC information retrieved from the vehicle control module; the latter allows you to erase DTCs and other data from the ECU.
- **Live Data** — retrieves and displays live data and parameters from the vehicle's ECU.
- **Active Test** — provides specific subsystem and component tests. This selection may display as *Actuators*, *Actuator Test* or *Function Tests*. Available tests vary by vehicle.
- **Special Functions** — provides various component adaptations.
- **Coding** — reprograms adaptive data for vehicle control modules.
- **Programming** — downloads the latest software from the online server database through Internet access and reprograms the newest version into the vehicle's ECU.

➤ **To perform a diagnostics function**

1. Establish communication with the test vehicle via the VCI.
2. Identify the test vehicle by selecting from the menu options.
3. Locate the required system for testing by **Auto Scan** or through menu-driven selections in **Control Unit**.
4. Select the desired test from the Function Menu screen.





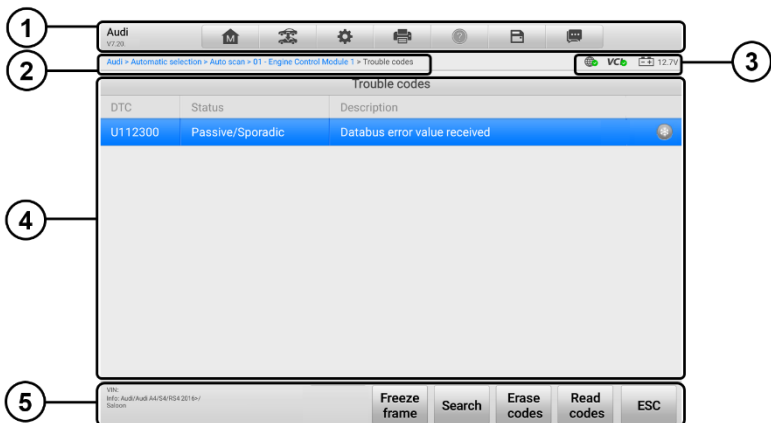

**Figure 4-11 Read Codes Screen**

1. Diagnostics Toolbar Buttons — see [Table 4-2 Diagnostics Toolbar Buttons](#) for detailed descriptions of the operations of each button.
2. Current Directory Path
3. Status Information Bar
4. Main Section
  - Column 1 — displays the retrieved codes from the vehicle.
  - Column 2 — indicates the status of the retrieved codes.
  - Column 3 — provides detailed descriptions for the retrieved codes.
5. Function Buttons
  - **Freeze Frame** — ❄ icon appears when freeze frame data is available for viewing; Tap to display data screen. The Freeze Frame interface is similar to that of the Read Codes interface and shares similar operations.
  - **Search** — searches the selected DTC for additional information on the Internet.
  - **Erase Codes** — erases codes from the ECU. It is recommended that DTCs are read and needed repairs are performed before erasing codes.
  - **Read Codes** — retrieves and displays the DTCs from the vehicle control system. The Read Codes screen varies for each vehicle being tested.
  - **ESC** — returns to the previous screen or exit the function.

## 4.6.2 Erase Codes

After reading the retrieved codes from the vehicle and certain repairs have been made, you can erase the codes from the vehicle using this function. Before performing this function, make sure the vehicle's ignition key is in the ON (RUN) position with the engine off.

### ➤ To erase codes

1. Tap **Erase Codes** in the Function Buttons.
2. A warning message appears to inform you of data loss when this function is applied.
  - a) Tap **Yes** to continue. A confirmation screen appears when the operation is successfully done.
  - b) Tap **No** to exit.
3. Tap **ESC** on the confirmation screen to exit Erase Codes.
4. Perform the Read Codes function again to ensure the operation is successful.

## 4.7 Live Data

When this function is selected, the screen shows the data list for the selected module. The parameters display in the order that they are transmitted by the ECU, so expect variation among vehicles.

Gesture scrolling allows you to quickly move through the data list. Drag your finger up or down on the screen to reposition the parameters being displayed if the data occupies more than one screen. The figure below displays a typical Live Data screen:

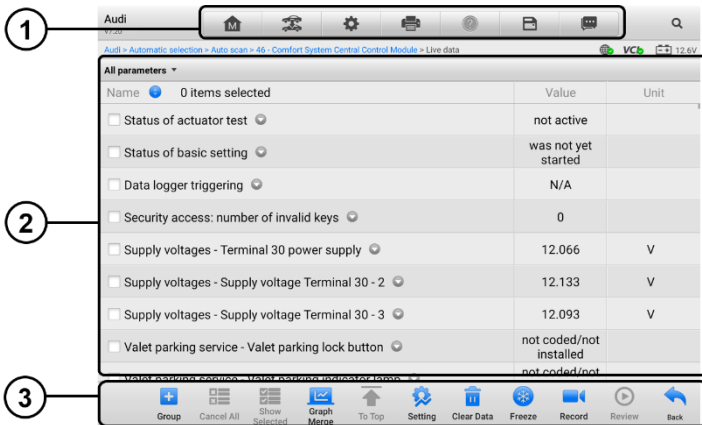

**Figure 4-12 Live Data Screen**

1. Diagnostics Toolbar Buttons — see [Table 4-2 Diagnostics Toolbar Buttons](#) for detailed descriptions of the operations of each button.
2. Main Section
  - Name Column — displays the parameters.
    - a) Check Box — tap the check box to the left of a parameter to select the item. Tap the check box again to deselect it.
    - b) Drop-down Menu — tap the drop-down menu to the right of the parameter to open a submenu, and view data display-mode options.
  - Value Column — displays the values of the parameters.
  - Unit Column — displays the units for the parameters. To change the Unit mode, tap the **Settings** button in the top toolbar and select a required mode. See [Unit](#).

## Display Mode

There are four display modes available for data viewing, allowing you to view various types of parameters in the mode best suited to represent the data.

Tap the drop-down menu to the right of a parameter to open a submenu. A total of 8 buttons will be displayed: The 4 buttons on the left represent different data display modes, plus one **Information** button (active when additional information is available), one **Add to Custom Group** button (tap to add the selected parameters to the custom group), one **Unit Change** button (for switching the unit of displayed data), and one **Trigger** button (tap to open the "Trigger Settings" window).

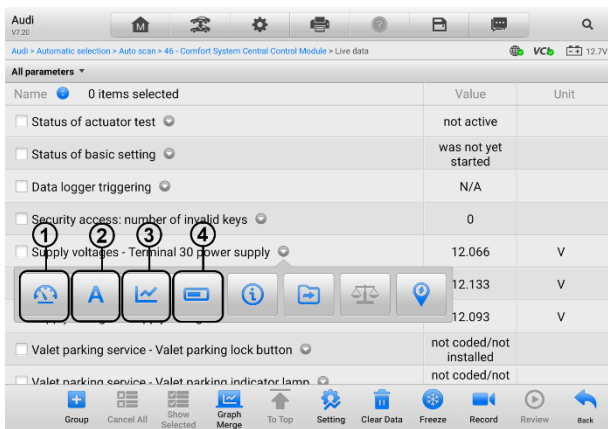

**Figure 4-13 Display Mode Screen**

Each parameter displays the selected mode independently.

- ① **Analog Gauge Mode** — displays the parameters in gauge charts.

② **Text Mode** — default displays the parameters as a text list.

**NOTE**

Some status parameters, such as a switch reading like ON, OFF, ACTIVE, and ABORT, can only be displayed in Text Mode. Others, such as a sensor reading, can be displayed in both text and graph modes.

③ **Waveform Mode** — displays the parameters in waveform graphs.

In this mode, five control buttons will appear to the right of the parameter, allowing you to manipulate the display status.

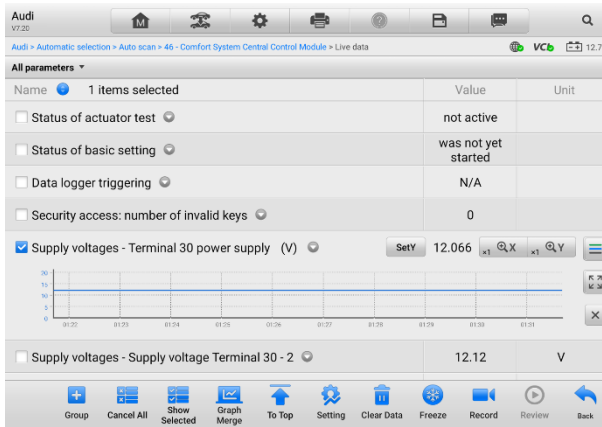

**Figure 4-14 Waveform Graph Mode Screen**

- Settings Button (SetY) — sets the minimum and maximum value of the Y-axis.
- Scale Button — changes the scale values.

There are two scale buttons, displayed above the waveform graph to the right side, which can be used to change the scale values of the X-axis and Y-axis of the graph. There are four scales available for the X-axis: x1, x2, x4 and x8, and three scales available for the Y-axis: x1, x2, and x4.

- Edit Button — edit the waveform color and line thickness.
- Zoom-in Button — tap once to display the selected data graph in full screen.
- Exit Button — tap to exit the waveform mode.

**Full Screen Display** — this option is only available in the waveform mode, and is mostly used in Graph Merge status for data comparison. There are three control buttons available on the top-right side of the screen under this mode.

- Scale Button — tap to change the scale values below the waveform graph. There are four scales available for the X-axis: x1, x2, x4 and x8, and three scales available for the Y-axis: x1, x2, and x4.
- Edit Button — tap to open an edit window, in which you can set the waveform color and the line thickness displayed for the selected parameter.
- Zoom-out Button — tap to exit full screen display.
- Exit Button — tap to exit waveform mode.

➤ **To edit the waveform color and line thickness in a data graph**

1. Select a parameter to be displayed in waveform mode.
2. Tap the **Edit** button, and an edit window will appear.

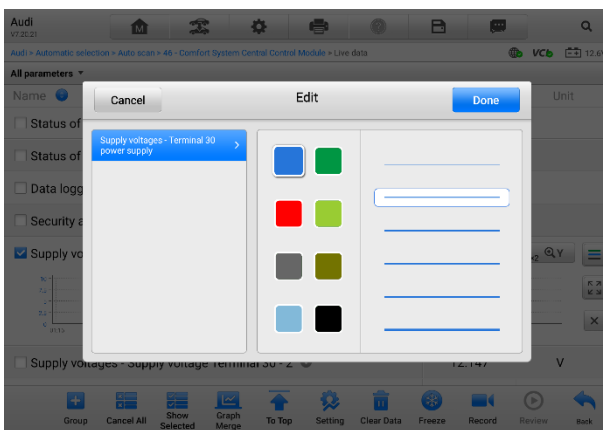

**Figure 4-15 Waveform Edit Screen**

3. The selected parameter is shown automatically in the left column.
4. Select a color from the second column.
5. Select a line thickness from the right column.
6. Tap **Done** to save the settings and exit, or tap **Cancel** to exit without saving.

**NOTE**

In full screen display mode, you can edit the waveform color and line thickness by tapping the **Edit** button on the top-right side of the screen.

**④ Digital Gauge Mode** — displays the parameters in the form of a digital gauge graph.

**Trigger Settings**

On the Trigger Settings screen, you can set a standard range by filling in minimum and maximum values. When exceeding these values, the trigger function will be executed

and the device will automatically record and save the generated data. You can review the saved live data by tapping the **Review** button at the bottom of the screen.

Tap the drop-down menu to the right of a parameter to open a submenu. The **Trigger** button is the last one in the submenu. Tap to display the Trigger Settings window.

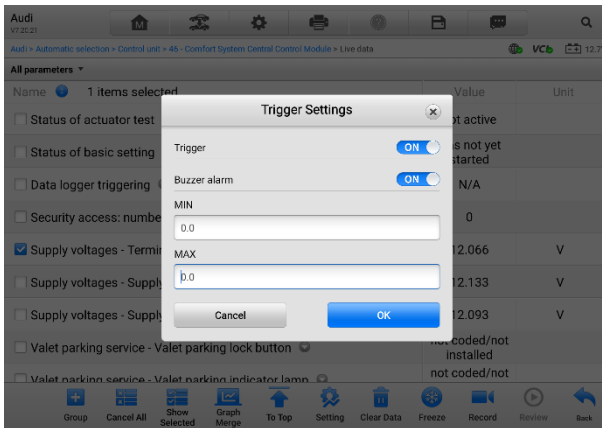

**Figure 4-16 Trigger Setting Screen**

Two buttons and two input boxes are available in the Trigger Settings window.

- Trigger — toggles the trigger on and off. The trigger is **ON** by default.
- Buzzer Alarm — switches the alarm on and off. The alarm function makes a beeping sound as an alert when the data reading reaches the preset minimum or maximum value. The buzzer alarm will only sound at the first trigger.
- MIN — tap this input box to display a virtual keyboard to enter a lower threshold value.
- MAX — tap this input box to display a virtual keyboard to enter an upper threshold value.

➤ **To set a trigger**

1. Tap the drop-down button to the right of a parameter to open a submenu.
2. Tap the **Trigger** button to the right of the submenu to open the Trigger Settings window.
3. Tap the **MIN** input box and enter the minimum threshold value.
4. Tap the **MAX** input box and enter the maximum threshold value.

5. Tap **OK** to save the settings and return to the Live Data screen, or tap **Cancel** to exit without saving.

When the trigger is successfully set, a trigger mark displays in front of the parameter. The mark is gray when it is not triggered, and displays orange when triggered. Moreover, two horizontal lines display on each of the data graphs (when Waveform Graph Mode is applied) to indicate the threshold values. The limit lines are shown in different colors to differentiate them from the parameter waveforms.

### 3. Function Buttons

The operations of the function buttons on the Live Data screen are described below:

- ✧ **Group** — tap to set the selected parameters to the same group.
- ✧ **Cancel All** — tap to cancel all selected parameters. Up to 50 parameters can be selected at one time.
- ✧ **Show Selected/Show All** — tap to toggle between the two options; one displays the selected parameters, the other displays all the available items.
- ✧ **Graph Merge** — tap to merge selected data graphs (for Waveform Mode only). This function is very useful when comparing different parameters.

---

#### **NOTE**

This mode supports a Graph Merge of 2 to 5 digital parameters. Non-digital parameters are not supported.

---

#### ➤ **To merge selected data graphs**

1. Select parameters to be merged.
2. Tap the **Graph Merge** button at the bottom of the Live Data screen.
  - a) This mode only supports parameters that can be represented digitally. If non-digital parameters are selected, a message will display advising the user that the selected parameters are not supported in this mode and to select 2 to 5 digital parameters. Tap the **Got It** button to return to the previous screen and select supported parameters.
  - b) If selected parameters are not supported in this mode, a message will display advising the user to select only parameters that are supported. A message will also display if more than 5 parameters have been selected. Please select 2 to 5 of the supported parameters and tap the **OK** button to merge.



3. Tap the **Cancel Merge** button at the bottom of the Live Data screen to cancel merge.

❖ **To Top** — moves a selected data item to the top of the list.

❖ **Setting** — tap to set the recording duration.

➤ **To set the live data record duration**

1. Tap the **Settings** button at the bottom of the Live Data screen.

2. Tap the > button to the right of **Recording Time After Trigger** bar and select a time length.

3. Tap **OK** to save the settings and return to the Live Data Settings screen, or tap the **X** button on the upper-right corner to exit without saving.

4. Tap **Done** on the upper-right corner of the Live Data Settings screen to confirm and save the settings, and return to the Live Data screen, or tap **Cancel** to exit without saving.

❖ **Clear Data** — tap to clear all cached live data.

❖ **Freeze** — displays the retrieved data in freeze mode.

- Previous Frame — moves to the previous frame of frozen data.

- Next Frame — moves to the next frame of frozen data.

- Play/Pause — tap to play/pause the frozen data.

- Resume — tap to exit the freeze data mode and return to normal data display.

❖ **Record** — starts recording the live data of the selected data. Tap the **Record** button at the bottom of the Live Data screen. A message will display prompting user to select parameters to record. Tap the **Got It** button to confirm. Scroll down and select data to record. Tap the **Record** button to start recording. Tap the **Resume** button to stop recording. The recorded live data can be viewed in the Review section at the bottom of the Live Data screen. The recorded data can also be reviewed in the Data Manager.

- Resume — Tap to stop data recording and return to normal data display.

- Flag — appears when the Record function is applied. Tap to set flags to note points of interest when recording data. Notes can be added during playback in Review or Data Manager. Select the preset flag to open a popup window and display a virtual keyboard to input notes.

- ◇ **Review** — reviews the recorded data. Tap to display a recording list, and select one item to review.

---

## NOTE

Only the data recorded during the current operation can be reviewed on the Live Data screen. All the historical recorded data can be reviewed in Review Data in the Data Manager application.

---

- Previous Frame — switches to the previous frame of recorded data.
  - Next Frame — switches to the next frame of recorded data.
  - Play/Pause — tap to play/pause recorded data.
  - Show Selected — displays the selected parameters.
  - Graph Merge — merges selected data graphs.
  - Back — exits the Review screen and returns to the Live Data screen.
- ◇ **Back** — returns to the previous screen or exits the function.

## 4.8 Active Test

---

The Active Test function is used to access vehicle-specific subsystem and component tests. Available tests vary by vehicle.

During an active test, the tablet sends commands to the ECU to activate the actuators. This test determines the integrity of the system or part by reading ECU data or by monitoring the operation of the actuators. Such tests may include toggling a solenoid, relay, or switch, between two positions.

Selecting Active Test displays a menu of test options. Available tests vary by vehicle. Select a test from the menu options. Follow the instructions displayed on the screen to complete the test. Procedures and instructions vary by vehicle.

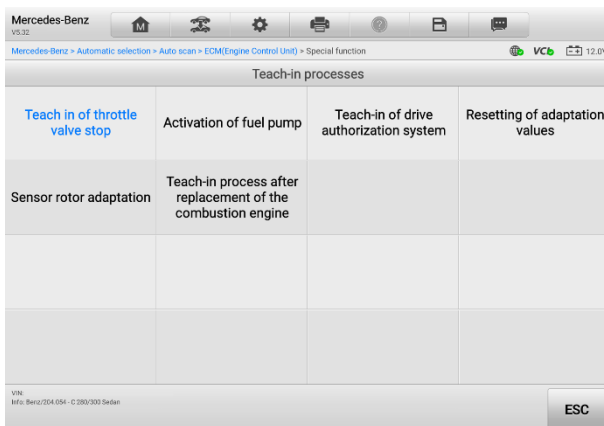

**Figure 4-17 Active Test Screen**

The function buttons in the lower-right corner of the Active Test screen manipulate the test signals. The operational instructions are displayed in the main section of the test screen. Follow the on-screen instructions and make appropriate selections to complete the tests. Tap the **ESC** button to exit the test when finished.

## 4.9 Special Functions

These functions perform various component adaptations, including the recalibration or configuration of certain components after repairs or replacements have been completed. Select a function to display detailed function information and the execution screen.



**Figure 4-18 Special Function Screen**

## 4.10 Programming and Coding

---

Since the introduction of OBDII and leading up to modern hybrids and EVs, hardware and software technologies in cars have been advancing at an exponential rate. Updating software may be the only way to fix the following issues:

- Drivability
- Fuel Efficiency
- Power Loss
- Fault Codes
- Durability of Mechanical Parts

The Programming and Coding function is used to “re-flash” the vehicle control modules, which allows you to update the computer software of the vehicle to the latest version, as well as to reprogram adaptive data of certain components after making repairs or replacements.

---

### NOTE

The programming function applies only when the vehicle is connected to a VCI, which serves as a PassThru interface to establish communication and transfer data to the vehicle's ECU.

---

Available programming or coding operations vary by test vehicle. Only available operations display in the tablet menu.

There are two general types of programming operations:

- A. Coding — also known as *Teach-in Program*, or *Component Adaptation*, is used to reprogram adaptive data for vehicle control modules after repairs or replacements of vehicle parts.
- B. Reprogramming — downloads the latest version of software from the online server database via the Internet access (this procedure is done automatically when the tablet is connected to the Internet, so there is no need to check for software updates yourself), and reprograms the newest version into the vehicle's ECU.

---

### NOTE

Ensure that the tablet is connected to a stable Internet access before applying the ECU programming function, so that the tablet is able to access the vehicle manufacturer's server for update service.

---

Selecting the Programming or Coding function opens a menu of operation options that varies by vehicle make and model. Selecting a menu option either displays a

programming interface or opens another menu of additional choices. Follow all screen instructions while performing the programming or coding operations. How and what information is presented on the screen vary by the type of operation being performed.

## 4.10.1 Coding

The main section of the Coding screen displays a list of vehicle components and the coding information that mainly consists of two parts:

1. All available systems for coding are displayed on the left side, and the coding data or value on the right side.
2. The bottom of the main section displays the function buttons that enable you to manipulate the operation.

Check the vehicle condition and the coding information carefully. Use the function button to edit codes for the corresponding components. Tap **Send** when you finish editing all items. When the operation is completed, an execution status message, such as Completed, Finished or Successful, may appear.

Tap **ESC** to exit the function.

## 4.10.2 Reprogramming

**Before reprogramming begins:**

- The tablet must be connected to a stable Wi-Fi network.
- The tablet must be connected to the VCI by USB.
- The tablet battery must be fully charged during module programming. Connect the tablet to a charger if needed.
- Attach battery maintainer to vehicle battery to ensure a steady voltage is maintained throughout programming. Voltage requirements differ by vehicle manufacturer. Consult vehicle manufacturer recommendations prior to programming a module.
- Do not quit the application during module programming as the process may fail and may also result in permanent damage to the module.

Typical reprogramming operations require you to input and validate the VIN number first. Tap the input box and enter the correct number. The programming interface then appears.

The main section of the reprogramming interface offers information about the hardware, the current software version and the newest software versions to be programmed into the control units.

A series of on-screen operational instructions will display to guide you through the programming procedure. Carefully read the on-screen information and follow the instructions to execute the programming procedure.

### 4.10.3 Re-flash Errors

---

#### IMPORTANT

When reprogramming onboard, always make sure the vehicle battery is fully charged and in good working condition. During reprogramming, the operation may fail if voltage falls below the proper operation voltage. Sometimes a failed operation can be recovered, but the failed reprogramming can also ruin the control module. We recommend connecting an external battery maintainer to the vehicle to ensure a steady voltage throughout reprogramming. The required voltage differs by vehicle manufacturer. Consult vehicle manufacturer for correct voltage to be maintained.

---

Occasionally a flash update procedure may not complete properly. Common causes of flash errors include: poor cable connections among the tablet, VCI, and vehicle, the vehicle ignition being switched off before the flash procedure is complete, or low vehicle battery voltage.

If the process quits, recheck all the cable connections to assure good communications and initialize the flash procedure. The programming procedure will automatically repeat if the previous operation does not succeed.

## 4.11 Generic OBDII Operations

---

The OBDII/EOBD vehicle diagnosis option offers a quick way to check for DTCs, isolate the cause of an illuminated malfunction indicator lamp (MIL), check monitor status prior to emissions certification testing, and perform other emissions-related services. The OBDII direct access option is also used for testing OBDII/EOBD-compliant vehicles that are not included in the database. Diagnostics toolbar buttons at the top of the screen are available for specific vehicle diagnostics. See [Table 4-2 Diagnostics Toolbar Buttons](#) for details.

### 4.11.1 General Procedure

#### ➤ To access the OBDII/EOBD diagnostics functions

1. Tap the **Diagnostics** application button in the MaxiSys Job Menu. The Vehicle Menu displays.
2. Tap the **EOBD** button. There are two options to establish communication with the vehicle.
  - Auto Scan — select to establish communication using each protocol in

order to determine which one the vehicle is using.

- Protocol — select to open a submenu of various protocols. A communication protocol is a standardized way of data communication between an ECM and a diagnostics tool. Global OBD may use several different communication protocols.
3. Select a specific protocol if the **Protocol** option is selected. Wait for the OBDII Diagnostics Menu to appear.

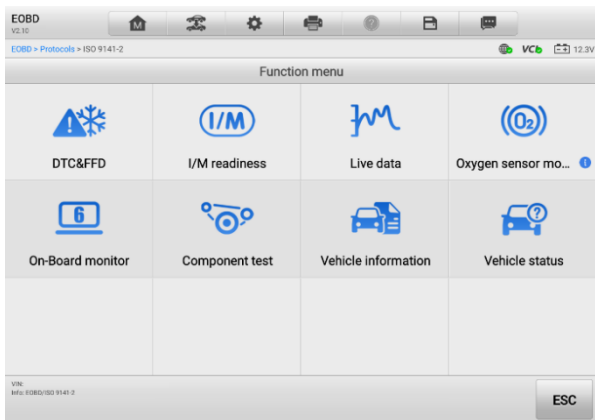

**Figure 4-19 OBDII Diagnostics Menu**

4. Select a function option to continue.
- DTC & FFD
  - I/M Readiness
  - Live Data
  - Oxygen Sensor Monitor
  - On-Board Monitor
  - Component Test
  - Vehicle Information
  - Vehicle Status

---

**NOTE**

Supported functions may vary by vehicle.

---

## 4.11.2 Function Descriptions

This section describes the various functions of each diagnostics option:

### 4.11.2.1 DTC & FFD

When this function is selected, the screen displays a list of Current Codes and Pending Codes. When the Freeze Frame data of certain DTCs are available for viewing, a snowflake icon will display on the right side of the DTC item. The Erase Codes function can be applied by tapping the function button at the bottom of the screen.

- **Current Codes**

Current codes are emission-related DTCs from the ECU of the vehicle. OBDII/EOBD Codes have a priority according to their emission severity, with higher-priority codes overwriting lower-priority ones. The priority of the code determines the illumination of the Malfunction Indicator lamp (MIL) and the erasing-code procedure. Manufacturers rank codes differently, so DTCs may vary by vehicle.

- **Pending Codes**

These are codes whose storing conditions have been met during the last drive cycle, but need to be met on two or more consecutive drive cycles before the DTC stored. The purpose of displaying pending codes is to assist the service technician after a vehicle repair when diagnostics information is cleared, by reporting test results after a single driving cycle.

- a) If a test fails during the driving cycle, the DTC associated is reported. If the pending fault does not occur again within 40 to 80 warm-up cycles, the fault is automatically cleared from memory.
- b) Test results reported do not necessarily indicate a faulty component or system. If test results indicate another failure after additional driving, a DTC is stored to indicate a faulty component or system.

- **Freeze Frame**

In most cases, the stored frame is the last-DTC reported. Certain DTCs, those that have a greater impact on vehicle emission, have a higher priority. In these cases, DTC of the highest priority is the one for which the freeze frame records are retained. Freeze frame data includes a “snapshot” of critical parameter values at the time the DTC is stored.

- **Erase Codes**

This option is used to clear all emission-related diagnostics data including DTCs, freeze frame data, and specific manufacturer-enhanced data from the vehicle ECU. This option resets the I/M Readiness Monitor Status for all vehicle monitors to Not Ready or Not Complete status.



A confirmation screen displays when the clear codes option is selected to prevent accidental loss of data. Select Yes on the confirmation screen to continue, or No to exit.

#### 4.11.2.2 *I/M Readiness*

This function is used to check the readiness of the monitoring system. It is an excellent function to use prior to having a vehicle inspected for state emissions compliance. Selecting I/M Readiness opens a submenu with two choices:

- ✧ Since DTCs Cleared — displays the status of monitors since the last time the DTCs were erased.
- ✧ This Driving Cycle — displays the status of monitors since the beginning of the current drive cycle.

#### 4.11.2.3 *Live Data*

This function enables the display of real-time PID data from the ECU. Displayed data includes analog and digital input and output, and system status information broadcast in the vehicle data stream.

Live data can be displayed in various modes. See [Live Data](#) for detailed information.

#### 4.11.2.4 *Oxygen Sensor Monitor*

This function allows retrieval and review of recent Oxygen sensor monitor test results stored on the vehicle on-board computer.

The Oxygen Sensor Monitor test function is not supported by vehicles that communicate using a controller area network (CAN). For Oxygen Sensor Monitor tests results of CAN-equipped vehicles, refer to [On-Board Monitor](#).

#### 4.11.2.5 *On-Board Monitor*

This function allows you to view the results of On-Board Monitor tests. The tests are useful after the service when a vehicle control module memory is already erased.

#### 4.11.2.6 *Component Test*

This function enables dual-directional control of the ECU so that the diagnostics tool can transmit control commands to operate the vehicle systems. This function is useful in determining how well the ECU responds to a command.

#### 4.11.2.7 *Vehicle Information*

This function enables the display of the vehicle identification number (VIN), calibration identification number, calibration verification number (CVN), and other test vehicle information.

### 4.11.2.8 Vehicle Status

This function checks the current condition of the vehicle, such as the communication protocols of OBDII modules, number of fault codes, and status of the Malfunction Indicator Lamp (MIL).

## 4.12 Diagnostics Report

---

### 4.12.1 Pre-scan and Post-scan

After performing pre-scan and post-scan functions by entering the same maintenance order number, tap **Data Manager > Vehicle History** to select the historical test record named with the maintenance order number. Both the pre-scan results and post-scan results will be displayed in the same historical test record, which can be generated as a PDF report for easily comparing the changes between pre-scan and post-scan.

- Pre-Scan Function

Select and tap a vehicle button from the Vehicle Menu screen. Enter the maintenance order number in the pop-up box to scan and detect the whole vehicle. You can also add pictures to record the current condition of the vehicle. Once the pre-scan is completed, you are not allowed to perform pre-scan again, and the scan result cannot be modified.

- Post-Scan Function

After the pre-scan is complete, exit the current test vehicle and tap the vehicle button from the Vehicle Menu screen to reconnect again. Enter the same maintenance order number in the pop-up box. The screen for post-scan will display. The post-scan record will be generated when the scan is completed. The pre-scan results and post-scan results will be displayed in the same historical test record.

---

 **NOTE**

The post-scan function can be performed repeatedly. After exiting the vehicle, you only need to tap the vehicle button from the Vehicle Menu screen to reconnect again, then enter the same maintenance order number in the pop-up box and follow the steps to rescan. The last one is the final post-scan result.

---

### 4.12.2 Diagnostics Report Saving, Viewing, and Sharing

The diagnostic report can be reviewed, saved, and shared with others through many ways.

### 4.12.2.1 Diagnostics Report Saving

- Via the **History** function:

- 1) Enter the main screen of the Diagnostics application, and tap **History** on the top toolbar.

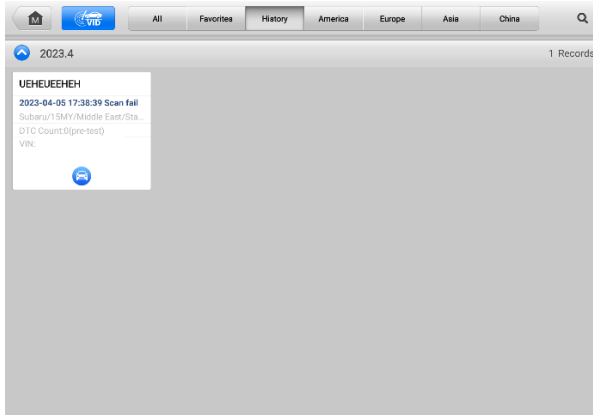

**Figure 4-20 History Screen**

- 2) Select a history record and tap the ellipses **⋮** button in the upper-right corner.

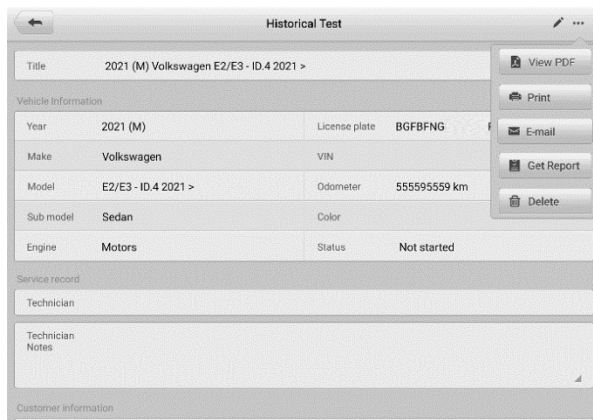
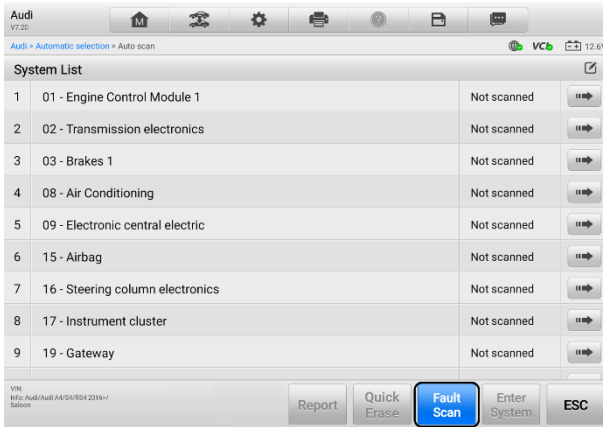

**Figure 4-21 Historical Test Screen**

- 3) Tap **View PDF** to view the report directly. Or tap **Get Report**, enter the license plate and current mileage, and then tap **Save > View Report** to save and view the report.

- Via the **Auto Scan** function:

- 1) Enter the Auto Scan page and tap **Fault Scan** in the Function Button Bar at the bottom of the screen.



**Figure 4-22 Auto Scan Screen Sample 1**

- 2) When the system scan is completed, tap **Report** in the Function Button bar at the bottom of the screen.

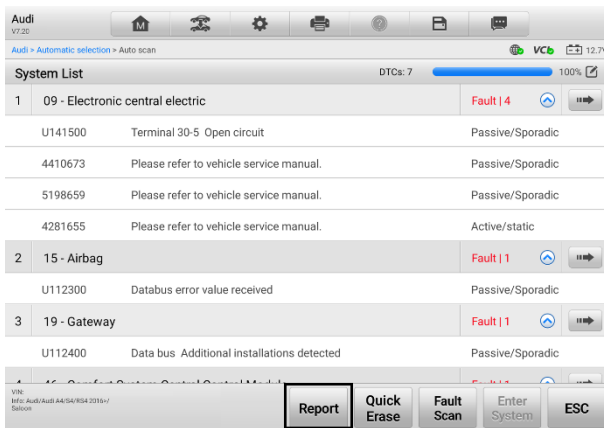



**Figure 4-23 Auto Scan Screen Sample 2**

- Via the buttons on the Navigation Bar:

The diagnostic report can also be viewed from such diagnostics functions screen including Auto scan and Trouble codes. There are two ways to view the saved reports:

- ✦ Tap the  button in the Diagnostics Toolbar and select **Save as PDF**. Enter

the license number and tap **Save**. Tap the  button on the upper-right of the screen to view the report.

- ✧ Tap the  button in the Diagnostics Toolbar and select **Report to Cloud**. Enter the license number and current mileage. Then tap **Save**.

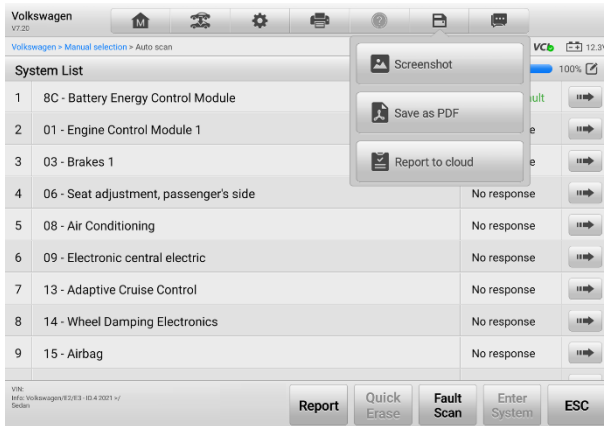

**Figure 4-24 Auto Scan Screen**

#### 4.12.2.2 Diagnostic Report Viewing

All the saved reports can be viewed in the Data Manger application.

- ✧ Tap **Data Manager > Vehicle History**. Select a specific vehicle history record and then tap **View PDF** in the upper-right corner to view the report.
- ✧ Once you save the reports by tapping the **Save as PDF** button, tap **Data Manager > PDF** to view these local reports.
- ✧ Once you save the reports by tapping the **Get Report** or **Report to Cloud** button, tap **Data Manager > Cloud Report** to view these reports saved to the Autel cloud platform.

#### 4.12.2.3 Diagnostic Report Sharing

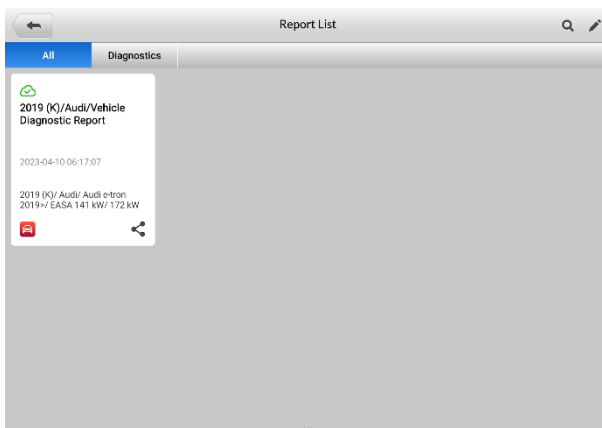

- 1) Tap **Data Manager > Cloud Report** to enter the Report List screen.



**Figure 4-25 Report List Screen**

---

**NOTE**

Note that if the report displays , it means the report has been uploaded to the cloud successfully, and you can share the report with others; if the report displays , it means the report has failed to upload to the cloud, but will try to automatically upload to the cloud when entering the Report again.

- 
- 2) Tap the  on the lower-right corner of the report.
  - 3) There are three ways for report cloud sharing: scan the QR code, send by email, send by SMS (via phone number).

## 4.13 Exit Diagnostics

---

The Diagnostics application operates while communication with the vehicle is still active. It is important to properly exit from the diagnostics operation interface to stop all communications with the vehicle before closing the Diagnostics application.

---

**NOTE**

Damage to the vehicle electronic control module (ECM) may occur if communication is disrupted. Ensure all forms of communication links such as data cable, USB cable, and wireless or wired network, are properly connected throughout the test. Exit all interfaces before disconnecting the test cable and power supply.

➤ **To exit the Diagnostics application**

- On an active diagnostic screen
  1. Tap the **Back** or **ESC** button to exit a diagnostic session.

2. Or tap **Vehicle Swap** button in the diagnostics toolbar to return to the Vehicle Menu screen.
- On the Vehicle Menu screen
    1. Tap the **Home** button in the top toolbar.
    2. Or tap the **Back** button in the navigation bar at the bottom of the screen.
    3. Or tap the **Home** button in the diagnostics toolbar to exit the application directly and return to the MaxiSys Job Menu

Now, the Diagnostics application is no longer communicating with the vehicle and it is safe to open other MaxiSys applications or exit the MaxiSys Diagnostics System and return to the Home screen.

# 5 Service

The **Service** section is specially designed to provide quick access to the vehicle systems for various scheduled service and maintenance tasks. The typical service operation screen is a series of menu-driven commands. Follow the on-screen instructions to select appropriate options, enter values or data, and perform necessary actions. The application will display detailed instructions to complete selected service operations.

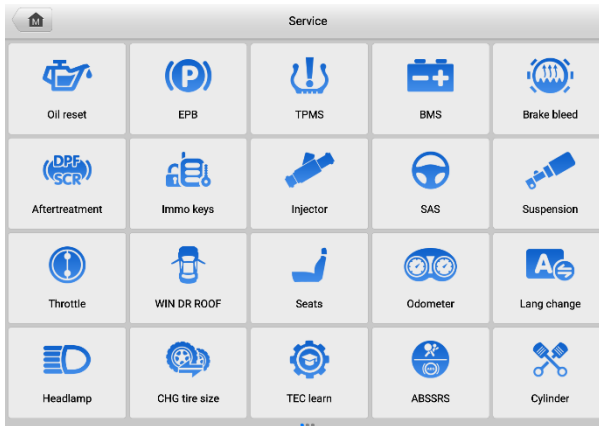

**Figure 5-1 Service Menu**

In this chapter we will discuss several of the most commonly used services.

## 5.1 Oil Reset Service

This function performs a reset of the Engine Oil Life system, which calculates the optimal oil life change interval depending on the vehicle driving conditions and climate. The Oil Life Reminder must be reset each time the oil is changed, so the system can calculate when the next oil change is required.

### NOTE

1. Always reset the engine oil life to 100% after every oil change.
2. All required work must be carried out before the service indicators are reset. Failure to do so may result in incorrect service values and cause DTCs to be stored by the relevant control module.



3. For some vehicles, the scan tool can reset additional service lights such as the maintenance cycle and service interval. On BMW vehicles for example, service resets include engine oil, spark plugs, front/rear brakes, coolant, particle filter, brake fluid, micro filter, vehicle inspection, exhaust emission inspection and vehicle checks.
- 

## 5.2 Electric Parking Brake (EPB) Service

---

This function has a multitude of ways to maintain the electronic braking system safely and effectively. The applications include deactivating and activating the brake control system, assisting with brake fluid control, opening and closing brake pads, and setting brakes after disc or pad replacement.

### 5.1.1 EPB Safety

It can be dangerous to perform Electric Parking Brake (EPB) system maintenance, so before you begin the service work, please keep these rules in mind.

- ✓ Ensure that you are fully familiar with the braking system and its operation before commencing any work.
- ✓ The EPB control system may be required to be deactivated before carrying out any maintenance/diagnostics work on the brake system. This can be done from the tool menu.
- ✓ Only perform maintenance work when the vehicle is stationary and on level ground.
- ✓ Ensure that the EPB control system is reactivated after the maintenance work has been completed.

---

#### NOTE

Autel accepts no responsibility for any accident or injury arising from the maintenance of the Electric Parking Brake system.

---

## 5.3 Tire Pressure Monitoring System (TPMS) Service

---

This function allows you to quickly look up the tire sensor IDs from the vehicle ECU, as well as to perform TPMS replacement and reset procedures after tire sensors are replaced.

## 5.4 Battery Management System (BMS) Service

---

The Battery Management System (BMS) allows the tool to evaluate the battery charge

state, monitor the close-circuit current, register the battery replacement, activate the rest state of the vehicle, and charge the battery via the diagnostics socket.

---

#### NOTE

- This function is not supported by all vehicles.
  - The sub functions and actual test screens of the BMS may vary by vehicle, please follow the on-screen instructions to make correct option selection.
- 

The vehicle may use either a sealed lead-acid battery or an Absorbed Glass Mat (AGM) battery. Lead acid battery contains liquid sulphuric acid and can spill when overturned. AGM battery (known as VRLA battery, valve regulated lead acid) also contains sulphuric acid, but the acid is contained in glass mats between terminal plates.

It is recommended that the replacement aftermarket battery has the same specifications, such as capacity and type, as the exiting battery. If the original battery is replaced with a different type of battery (e.g. a lead-acid battery is replaced with an AGM battery) or a battery with a different capacity (mAh), the vehicle may require reprogramming of the new battery type, in addition to, performing the battery reset. Consult the vehicle manual for additional vehicle-specific information.

## 5.5 Diesel Particle Filter (DPF) Service

---

The Diesel Particle Filter (DPF) function manages DPF regeneration, DPF component replacement teach-in and DPF teach-in after replacing the engine control unit.

The ECM monitors driving style and selects a suitable time to employ regeneration. Cars driven a lot at idling speed and low load will attempt to regenerate earlier than cars driven more with higher load and speed. For regeneration to take place, a prolonged high exhaust temperature must be obtained.

In the event of the car being driven in such a way that regeneration is not possible, i.e., frequent short journeys, a diagnostics trouble code will eventually be registered in addition to the DPF light and “Check Engine” indicators displaying. A service regeneration can be requested in the workshop using the diagnostics tool.

Before performing a forced DPF regeneration using the tool, check the following items:

- The fuel light is not on.
- No DPF-relevant faults are stored in system.
- The vehicle has the specified engine oil.
- The oil for diesel is not contaminated.

---

## **❗ IMPORTANT**

Before diagnosing the problem vehicle and attempting to perform an emergency regeneration, it is important to obtain a full diagnostics log and read out relevant measured value blocks.

---

---

## **🔧 NOTE**

1. The DPF will not regenerate if the engine management light is on, or there is a faulty EGR valve.
  2. The ECU must be re-adapted when replacing the DPF and when topping up the fuel additive Eolys.
  3. If the vehicle needs to be driven in order to perform a DPF service, a second person is needed for the function. One person should drive the vehicle while the other person observes the screen on the Tool. Do not attempt to drive and observe the scan tool at the same time. This is dangerous and puts your life and the lives of other motorists and pedestrians at risk.
- 

## **5.6 Steering Angle Sensor (SAS) Service**

---

SAS Calibration permanently stores the current steering wheel position as the straight-ahead position in the SAS EEPROM. Therefore, the front wheels and the steering wheel must be set exactly to the straight-ahead position before calibration. In addition, the VIN is also read from the instrument cluster and stored permanently in the SAS EEPROM. On successful completion of calibration, the SAS fault memory is automatically cleared.

Calibration must always be carried out after the following operations:

- Steering wheel replacement
- SAS replacement
- Any maintenance that involves opening the connector hub from the SAS to the column
- Any maintenance or repair work on the steering linkage, steering gear or other related mechanism
- Wheel alignment or wheel track adjustment
- Accident repairs where damage to the SAS, SAS assembly, or any part of the steering system may have occurred

---

 **NOTE**

- Autel accepts no responsibility for any accident or injury arising from servicing the SAS system. When interpreting DTCs retrieved from the vehicle, always follow the manufacturer's recommendation for repair.
  - All software screens shown in this manual are examples, and actual test screens may vary by test vehicle. Pay attention to the menu titles and onscreen instructions to make correct option selections.
  - Before starting procedure, make sure the vehicle has an ESC button. Look for button on dash.
-

# 6 Battery Test

Battery Test conducts battery and cranking/charging systems analysis and enables technicians to view the health status of the vehicle's battery and electrical system. Functions include in-vehicle test and out-vehicle test.

---

## NOTE

The MaxiBAS BT506 tester is sold separately.

---

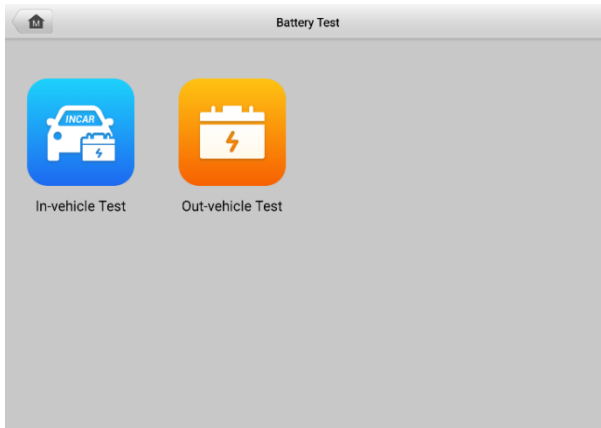

Figure 6-1 *Battery Test Screen*

---

## 6.1 Test Preparation

### 6.1.1 Inspect the Battery

Before starting a test, observe the battery for:

- Cracking, buckling or leaking (If you see any of these defects, replace the battery.)
- Corroded, loose or damaged cables and connections (Repair or replace as needed.)
- Corrosion on the battery terminals, and dirt or acid on the case top (Clean the case and terminals using a wire brush and a mixture of water and baking soda.)

## 6.1.2 Connect the Battery Tester

### ➤ To pair the BT506 with the MaxiSys Elite II Pro tablet

1. Press and hold the **Power** button to turn on both the MaxiSys tablet and BT506. Ensure that the unit is sufficiently charged before using.
2. Enable **Bluetooth** on the MaxiSys Elite II Pro by tapping **VCI Manager > BAS BT**, and the tablet automatically scans for an available tester for pairing. The device name will appear as “Maxi” suffixed with a serial number.
3. Check the serial number of your BT506 tester and select the desired device for pairing.
4. When paired successfully, the connection status will read as “Connected” and the Status LED will flash blue.

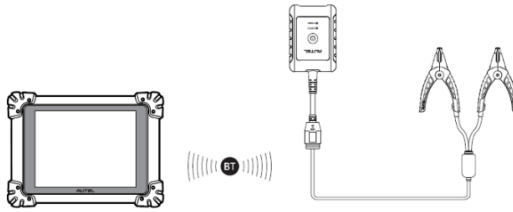

### ➤ To connect to a battery

1. Press and hold the **Power** button to turn on the BT506.
2. Connect the red clamp to the positive (+) terminal and the black clamp to the negative (-) terminal of the battery.

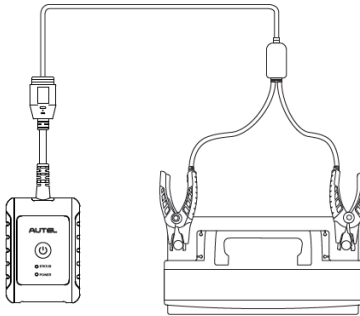

## 6.2 In-vehicle Test

In-vehicle Test is used for testing batteries that are installed in a vehicle. An in-vehicle test includes Battery Test, Starter Test, and Generator Test. These tests help determine the health status of the battery, the starter, and the generator.

### IMPORTANT

A disclaimer page will appear when accessing any function on the Home screen for the first time. Please read the end user agreement and tap **Accept** to continue. If you tap **Decline**, you will not be able to use the features properly.

### NOTE

The complete in-vehicle test includes battery test, starter test and generator test, in sequence.

Prior to testing any battery, ensure that the battery tester is paired with the tablet via Bluetooth and is connected properly to a battery.

### 6.2.1 Start the Test

#### ➤ To start the battery test

1. Tap **Battery Test** from the MaxiSys Job Menu. Select **In-vehicle Test**.
2. Confirm your vehicle information and make sure the VIN information is filled.
3. Confirm your battery information, including voltage, type, standard, and capacity. Tap **Next** to continue.

Type	Standard	Capacity
		590
		595
FLOODED	CCA	600
AGM	SAE	605
AGM SPIRAL	CA	610





Figure 6-2 *Battery information Screen*

**NOTE**

In the Settings application, the Battery Test option allows you to change the requirement for entering the VIN information. If the setting is enabled, supplying the VIN is no longer mandatory.

Please refer to the table below for a list of buttons that may appear when accessing the functions:

**Table 6-1 Top Toolbar Buttons**

Button	Name	Description
	<b>Battery Connection</b>	The value on the icon indicates the real-time voltage of the tested battery. In the battery test, the button will turn green if the battery is good; otherwise, it will turn red.
	<b>Next</b>	Tap to proceed.
	<b>Home</b>	Returns to the MaxiSys Job Menu.
	<b>Back</b>	Returns to the previous screen.
	<b>Exit</b>	Returns to the Job Menu.

## 6.2.2 Battery Test

1. Follow the on-screen instructions. Check the boxes once all required tasks are completed, and tap **Start Testing**.

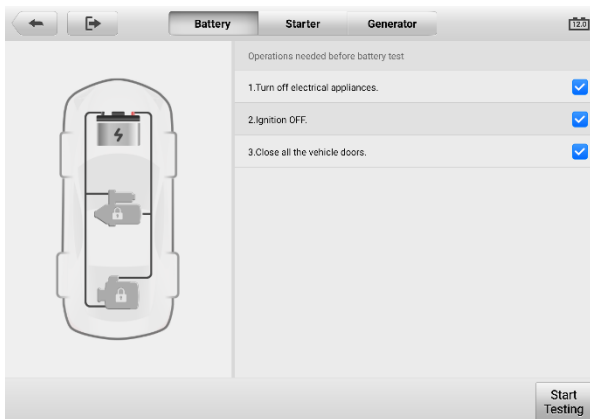

**Figure 6-3 Battery Test Screen**

2. Wait until the test is completed. The test results will be displayed on the tablet.





**Figure 6-4 Battery Test Results Screen**

## Battery Test Results

The battery test results include a color-coded results summary and a list of test data.

**Table 6-2 Test Results**

Result	Description
<b>Good Battery</b>	Battery is good.
<b>Good &amp; Recharge</b>	Battery is good but insufficiently charged. Recharge the battery.
<b>Charge &amp; Retest</b>	Battery requires charge to determine its condition.
<b>Bad Cell</b>	Replace the battery.
<b>Replace Battery</b>	Replace the battery.

### NOTE

Please always complete the battery test before you proceed to the starter and generator tests.

### 6.2.3 Starter Test

Follow the on-screen instructions to complete the test. Start the engine and let it idle. The test results will appear as follows:

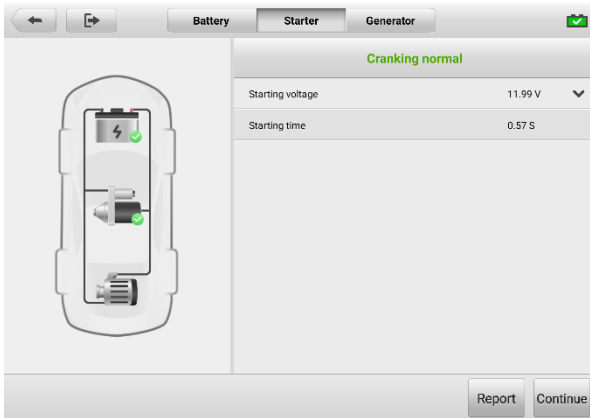

**Figure 6-5 Starter Test Result Screen**

**Table 6-3 Starter Test Results**

Result	Description
<b>Cranking Normal</b>	The starter is good.
<b>Current Too Low</b>	Low momentary discharge capacity.
<b>Voltage Too Low</b>	Low battery storage capacity.
<b>Not Started</b>	The starter is not detected for starting.

## 6.2.4 Generator Test

Follow the on-screen instructions to complete the test. The test results will appear as follows:

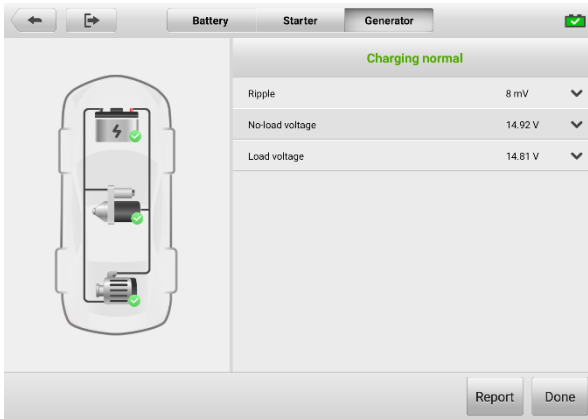

**Figure 6-6 Generator Test Results Screen**

**Table 6-4 Generator Test Results**

Result	Description
<b>Charging Normal</b>	The generator is functioning normally.
<b>Output Too Low</b>	<ul style="list-style-type: none"> <li>● The belt linking the starter and the generator is loose;</li> <li>● The cable linking the starter and battery is loose or corroded.</li> </ul>
<b>Output Too High</b>	<ul style="list-style-type: none"> <li>● The generator is not properly connected to the ground;</li> <li>● The voltage adjuster is broken and needs replacement.</li> </ul>
<b>Ripple Too Large</b>	The commutation diode is broken.
<b>No Output</b>	<ul style="list-style-type: none"> <li>● The cable is loose;</li> <li>● Some vehicles with power management systems do not provide path for charging due to the sufficient load capacity of the battery;</li> <li>● The generator or the voltage adjuster is broken and needs replacement.</li> </ul>

## 6.3 Out-vehicle Test

Out-vehicle Test is used to test the conditions of batteries that are not connected to a vehicle. This function aims to check the health status of the battery only.

### 6.3.1 Test Procedure

➤ **To start the out-vehicle test**

1. Tap **Battery Test** from the MaxiSys Job Menu. Select **Out-vehicle Test**.
2. Connect the tester clamps to the battery terminals.
3. Select the appropriate battery type, rating standard, and CCA value. Tap **Start Testing** to start the test.

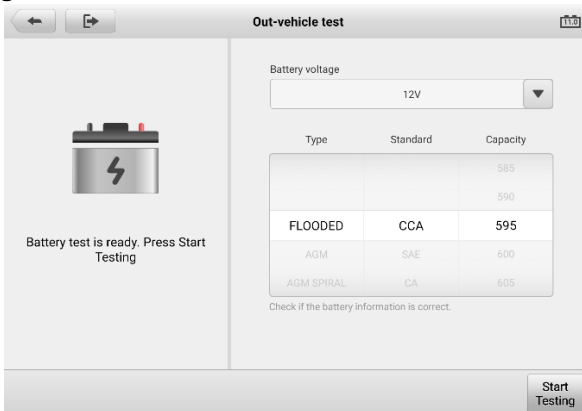

Figure 6-7 Out-vehicle Test Screen

4. The test results will display in a few seconds.

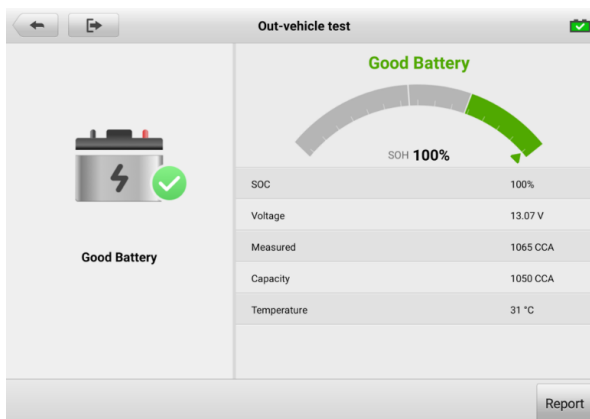

Figure 6-8 Out-vehicle Test Results Screen

## 6.3.2 Test Results

Icons are color-coded to indicate status.

**Table 6-5 Out-vehicle Test Results**

<b>Result</b>	<b>Description</b>
<b>Good Battery</b>	Battery meets required standards.
<b>Good &amp; Recharge</b>	Battery is good, but low on charge. Fully charge the battery. Check for causes of low charge.
<b>Charge &amp; Retest</b>	Battery requires charge to determine its condition.
<b>Replace Battery</b>	Battery fails to meet industry-accepted standards.
<b>Bad Cell</b>	Battery fails to meet industry-accepted standards.

# 7 Settings

Access the Settings menu to adjust default settings and view information about the MaxiSys system.

The following options are available for the MaxiSys system settings:

- Units
- Language
- Printing Settings
- Report Settings
- Push Notifications
- Auto Update
- Vehicle List
- AutoVID Setup
- System Settings
- About

## 7.1 Unit

---

This option allows you to change the units of measurement for the diagnostics system.

➤ **To change the units setting**

1. Tap the **Settings** application on the MaxiSys Job Menu.
2. Tap the **Units** option on the left column.
3. Select the appropriate units of measurement. A check mark displays to the right of the selected unit.
4. Tap the **Home** button on the top-left corner to return to the MaxiSys Job Menu, or select another settings option for further system setup.

## 7.2 Language

---

This option allows you to change the display language of the MaxiSys system.

➤ **To adjust the language setting**

1. Tap the **Settings** application on the MaxiSys Job Menu.
2. Tap the **Language** option on the left column.
3. Select the appropriate language. A check mark displays to the right of the selected language.
4. Tap the **Home** button on the top-left corner to return to the MaxiSys Job Menu, or select another settings option for further system setup.

## 7.3 Printing Settings

---

### 7.3.1 Printing Setting

This option allows you to print from the tablet to a network printer via a computer.

➤ **To setup a printer connection**

1. Tap **Settings** on the MaxiSys Job Menu.
2. Tap **Printing Settings** on the left column.
3. Tap **Print via PC-Link** or **Print via Wi-Fi** to activate the printing function, which enables the device to send files to the printer through the PC via Wi-Fi or Ethernet connection.
4. Tap **Home** on the top-left corner to return to the MaxiSys Job Menu, or select another settings option for further system setup.

### 7.3.2 Printing Operations

➤ **To install the MaxiSys Printer driver**

1. Download **Maxi PC Suite** from [www.autel.com](http://www.autel.com) > *Support* > *Downloads* > *Autel Update Tools*, and install to your Windows-based PC.
2. Double-click on **Setup.exe**.
3. Select an installation language to launch the installation wizard.
4. Follow the instructions on the screen and click on **Next** to continue.
5. Click **Install** and the printer driver will be installed on the computer.
6. Click **Finish** to complete the installation.

This section describes how to receive files from the MaxiSys tablet and perform printing through the computer.

---

## NOTE

Make sure the computer with the Printing Services program installed is connected to a printer.

---

### ➤ To print from a computer

1. Make sure the tablet is connected to the computer network via Wi-Fi or LAN before printing.
2. Run the **PC Link** program on the computer.
3. Click **Test Print** to check whether the printer works properly.
4. Tap the **Print** button on the toolbar of the tablet. A test document will be sent to the computer.
  - If the **Auto Print** option in the MaxiSys Printer is selected, the MaxiSys printer will automatically print the received document.
  - If the **Auto Print** option in the MaxiSys Printer is not selected, click the **Open PDF File** button to view files. Select the file(s) to be printed and click **Print**.

---

## 7.4 Report Settings

This option automatically synchronizes the diagnostics information of the vehicle to the vehicle history and forms a diagnostics report for the user to upload. Tap the **ON/OFF** button to enable/disable the Report Upload to Cloud function. The button appears blue if the function is enabled and gray if the function is disabled.

---

## 7.5 Push Notifications

This option allows you to manage notifications. The Notification Preference is turned on by default and cannot be turned off by users so that certain system notifications such as system security warning will not be blocked. Internet access is required for receiving online messages.

### ➤ To manage other notifications

1. Tap the **Settings** application on the MaxiSys Job Menu.
2. Tap the **Push Notifications** option on the left column.
3. Tap the  button on the right of the Other Notifications option to open a drop-down list.
4. There are four options: Enable All Notifications, Limit to 3 Notifications or Less Per Week, Limit to 1 Notification Per Week, and Disable All Notifications. Select whichever you prefer.



5. Tap **Home** on the top-left corner to return to the MaxiSys Job Menu. Or select another settings option for the system setup.

When the Push Notifications function is performed and new messages are received by the MaxiSys device, a notification message displays on the MaxiSys Job Menu. Press on the message bar and drag it down to display a list of received messages. Slide the list up or down to view additional messages if present.

Tap a specific message to launch the corresponding application. For example, if you tap on an Update notification message, the Update application will be launched.

## 7.6 Auto Update

---

This option allows you to preset a time to update the software. There are three update options: OS Update, MaxiSys Update and Vehicle Update.

Tap **ON/OFF** to enable or disable Auto Update. The button displays blue if the Autel Update is enabled and displays grey if the Auto Update is disabled. Set the time of the day for updating. If a specific time is set, the selected software will be automatically updated at that specific time.

## 7.7 Vehicle List

---

This option allows you to sort the vehicles either by alphabetic order or by frequency of use.

### ➤ To adjust the vehicle list setting

1. Tap the **Settings** application on the MaxiSys Job Menu.
2. Select **Vehicle List** on the left column.
3. Select the required sort order. A check mark will display to the right of the selected item.
4. Tap the **Home** button in the top-left corner to return to the MaxiSys Job Menu, or select another settings option for further system setup.

## 7.8 AutoVID Setup

---

This option allows you to enable/disable the automatic vehicle VIN reading function. When this function is active, the tablet will read the vehicle VIN via the communication methods you enabled after the VCI is connected to the vehicle.

## 7.9 System Settings

---

This function provides you with direct access to the Android system settings interface, where you can adjust various system settings for the Android operating system, regarding wireless and networks settings, various device settings such as sound and display, as well as system security settings, and check related information about the Android system. Refer to your Android documentation for additional information.

## 7.10 About

---

The About function provides information about the MaxiSys diagnostics device, including the product name, version, hardware, and serial number.

➤ **To check the MaxiSys product information in About**

1. Tap the **Settings** application on the MaxiSys Job Menu.
2. Select the **About** option on the left column. The product information displays on the right.
3. Tap the **Home** button on the top-left corner to return to the MaxiSys Job Menu, or select another settings option for further system setup.

# 8 Data Manager

The Data Manager application allows you to store, print, and review the saved files, manage the workshop information, customer information records, and keep test vehicle records.





Selecting the **Data Manager** application opens the file system menu. There are nine main functions available.







**Figure 8-1 Data Manager Main Screen**

The table below describes each of the function buttons in the Data Manager application.

**Table 8-1 Buttons in Data Manager**

Button	Name	Description
	<b>Vehicle History</b>	View the diagnostics records.
	<b>Workshop Information</b>	View or edit the workshop profile information.
	<b>Customer</b>	Create a new customer account file.
	<b>Image</b>	View the saved screenshots.
	<b>Cloud Report</b>	View the saved reports and share cloud reports.

Button	Name	Description
	<b>PDF</b>	View the diagnostics reports.
	<b>Review Data</b>	View recorded data.
	<b>Data Logging</b>	View communications with Autel support service and ECU information for the test vehicle. The saved data can be reported and sent to the technical center via the Internet.
	<b>Uninstall Apps</b>	Uninstall applications.

## 8.1 Vehicle History

This function stores vehicle test records, including vehicle information and the retrieved DTCs from previous diagnostics sessions. Test information is summarized and displays in an easy-to-read table listing. The Vehicle History also provides direct access to the previously tested vehicles and allows you to directly restart a diagnostics session without needing to perform auto or manual vehicle selection.

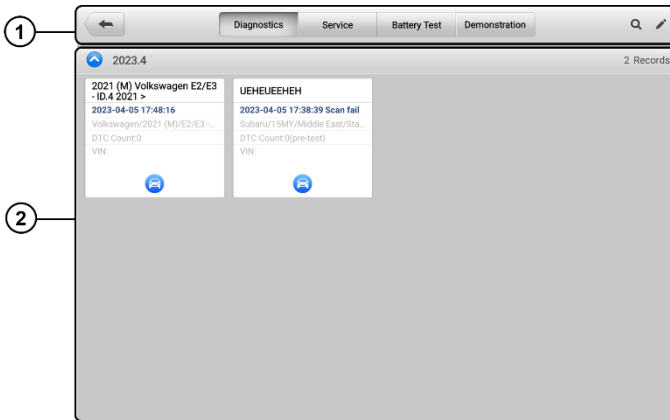

**Figure 8-2 Vehicle History Screen**

1. Top Toolbar Buttons — navigation and application controls.
2. Main Section — displays all the test records.

➤ **To activate a test session for a recorded vehicle**

1. Tap **Data Manager** on the MaxiSys Job Menu.
2. Select **Vehicle History** to open the screen. Tap **Diagnostics, Service** or **Battery Test** to select diagnostics test records or service test records.
3. Tap the **Diagnostics** icon at the bottom of the thumbnail of a vehicle record.
4. The Diagnostics screen of the vehicle displays and a new diagnostics session is activated. See [Diagnostics](#) for detailed instructions on vehicle diagnostics operations.

Or,

5. Select a vehicle thumbnail to select a record. A History Test record sheet appears. Review the recorded information of the test vehicle, and tap the **Diagnostics** button on the upper-right corner to continue diagnostics.

## 8.1.1 Historical Test Records

The Historical Test is a detailed data form of the tested vehicle, which includes general vehicle information, service record, customer information, and the diagnostics trouble codes retrieved from the previous test sessions. Technician Notes will also appear if present.

 **NOTE**

The MaxiSys tablet must connect to the VCI to restart test sessions on previously tested vehicles.

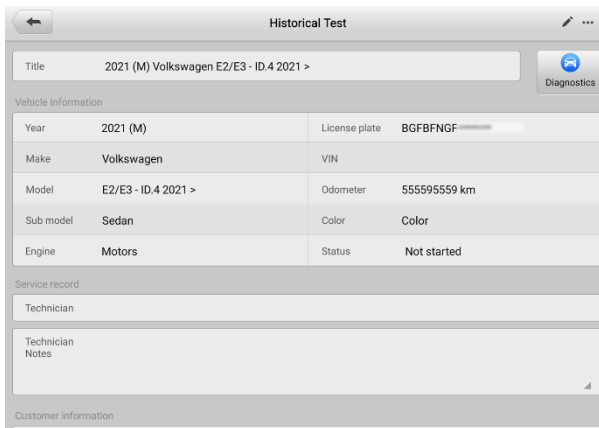

**Figure 8-3 Historical Test Records Sheet**

➤ **To edit a Historical Test Record**

1. Tap **Data Manager** in the MaxiSys Job Screen.

2. Select **Vehicle History**.
3. Select the specific vehicle history record thumbnail from the main section. The historical test record will appear.
4. Tap the **Edit** button (the pen icon) to start editing.
5. Tap each item to input information or attach files or images.
6. Tap **Add a Customer** to correlate the historical Records sheet to an existing customer account, or add a new account to be correlated with the test vehicle record. See [Customer](#) for more information.
7. Tap **Done** to save the updated record, or tap **Cancel** to exit without saving.

**NOTE**

The vehicle VIN, license number, and customer account are correlated by default. Vehicle records will automatically be correlated using this vehicle and customer identification.

## 8.2 Workshop Information

Workshop Information allows you to input, edit, and save the detailed workshop profile information, such as shop name, address, phone number and other remarks, which , when printing vehicle diagnostics reports and other associated test file, will display as the header of the printed documents.

**Figure 8-4 Workshop Information Sheet**

➤ **To edit the Workshop information sheet**

1. Tap **Data Manager** in the MaxiSys Job Screen.
2. Select **Workshop Information**.
3. Tap on each field to input the corresponding information.

4. Tap **Done** to save the updated workshop information, or tap **Cancel** to exit without saving.

## 8.3 Customer

---

The Customer function allows you to create and edit customer accounts. It helps you to save and organize all customer accounts correlated with the test vehicle history records.

➤ **To create a customer account**

1. Tap the **Data Manager** application in the MaxiSys Job Screen.
2. Select **Customer**.
3. Tap the **Add a customer** button. An empty information form displays. Tap each field to input the appropriate information.

---

 **NOTE**

Required fields are denoted by an asterisk.

---

4. For customers with more than one vehicle for service, tap **Add New Vehicle Information**. To delete the added vehicle information, tap the  button.
5. Tap **Complete** in the upper-right corner of the screen to save the customer information, or tap **Cancel** to exit without saving.

➤ **To edit a customer account**

1. Tap **Data Manager** on the MaxiSys Job Menu.
2. Select **Customer**.
3. Select a customer account by tapping the corresponding name card. A Customer Information record displays.
4. Tap the **Edit** icon on the top toolbar to start editing.
5. Tap on the input field to edit or amend information, and enter updated information.
6. Tap **Complete** to save the updated information, or tap **Cancel** to exit without saving.

➤ **To delete a customer account**

1. Tap **Data Manager** on the MaxiSys Job Menu.
2. Select **Customer**.
3. Tap the **Delete** icon on the right of a customer account. A message displays.
4. Tap **OK** to confirm the command, and the account is deleted. Tap **Cancel** to cancel the request.

## 8.4 Image







The Image section is a database containing all captured screenshots in .png file format.

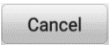

**Figure 8-5 Image Database Screen**

1. **Toolbar Buttons** — used to edit, print or delete stored image files. See [Table 8-2 Toolbar Buttons Description](#) for detailed information.
2. **Main Section** — displays the stored images.

**Table 8-2 Toolbar Buttons Description**

Button	Name	Description
	<b>Back</b>	Return to the previous screen.
	<b>Search</b>	Enter the search page.
	<b>Edit</b>	Display the editing toolbar to print, delete or view image.
	<b>Cancel</b>	Close the editing toolbar or cancel file search.
	<b>Search</b>	Quickly searches the image by entering the time of the screenshot.
	<b>Print</b>	Print the selected image.
	<b>Delete</b>	Delete the selected image.
	<b>Email</b>	Send the selected image via email.



➤ **To edit/delete image(s)**

1. Select **Data Manager** from the MaxiSys Job Menu.
2. Select **Images** to access the image database.
3. Tap **Edit** on the top right corner of the window. The editing screen displays.
4. Select the image(s) you want to edit by tapping the check box at the bottom-right corner of the image.
5. Tap **Delete** to delete the selected images or delete all images. Tap **Print** to print the selected image(s). Tap **Email** to send the selected image(s) to an email.

## 8.5 Cloud Report

---

This section displays the saved reports, which can be transferred to the Autel cloud platform once a stable network connection is established. These reports can then be viewed or shared with others. See [Diagnostics Report Saving, Viewing, and Sharing](#) for further details.

## 8.6 PDF Files

---

The PDF files designated for local viewing are displayed in this section. Enter the PDF database and select a file to access the saved information.

This section uses the standard Adobe Acrobat Reader application for file viewing and editing. Please refer to the associated Adobe Acrobat Reader manual for more detailed instructions.

## 8.7 Review Data

---

The Review Data function allows you to play back the recorded data frames from live data streams.

On the Review Data main screen, select a record file to play back.

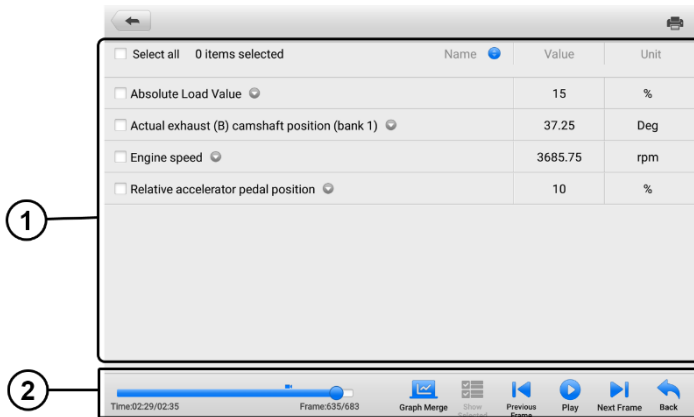

**Figure 8-6 Data Playback Screen**

1. Main Section — displays the recorded data frames.
2. Navigation Toolbar — allows you to manipulate data playback.

Use the Navigation Toolbar buttons to play back the record data from frame to frame.

Tap **Back** to exit data playback.

## 8.8 Data Logging

The Data Logging section allows you to launch the Support platform to view records of all feedback or not feedback (saved) data logs on the diagnostics system. For more information, please refer to [Data Logging](#).

## 8.9 Uninstall Apps

This section allows you to manage the software application installed on the MaxiSys Diagnostics System. Selecting this section opens a management screen, on which you can check all the available vehicle diagnostics applications.

Select the vehicle software you want to delete by tapping on the vehicle brand icon, after which the selected item will display a blue check mark at the upper-right corner. Tap the **Delete** button on the top bar to delete the software from the system database.

# 9 VCI Manager

The VCI Manager is for connecting the MaxiSys Elite II Pro tablet with a VCI through Bluetooth. This application allows you to pair the tablet with the VCI and to check its communication status.

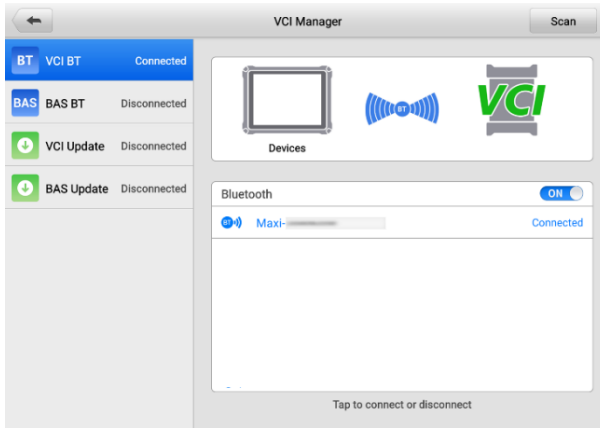

Figure 9-1 VCI Manager Screen

## 9.1 VCI Connection via Bluetooth

The VCI needs to be either connected to a vehicle or to an available power source, so that it is powered up during the synchronization procedure. Make sure the tablet has a fully charged battery or is connected to an external power supply.

### ➤ To pair the VCI with the tablet via Bluetooth

1. Power on the tablet.
2. Connect the 26-pin end of the main cable to the VCI's vehicle data connector.
3. Connect the 16-pin end of the main cable to the vehicle Data Link Connector (DLC).
4. Tap **VCI Manager** on the MaxiSys Job Menu of the tablet.
5. Select **VCI BT** (short for VCI Bluetooth) from the connection mode list. Tap the Bluetooth toggle to turn it **ON**. The device will start searching for available units for pairing.
6. Depending on the type of VCI you use, the device name may appear as "Maxi" suffixed with a serial number. Select the appropriate device for connection.

7. When connection is established, the connection status reads “Connected.”
8. The VCI button on the system Navigation bar at the bottom of the screen displays a green badge with a BT icon, indicating the tablet is connected to the VCI.

---

 **NOTE**

A VCI can be paired to only one tablet at a time, and once it has been paired, the device will not be discovered by any other unit.

---

## 9.2 BAS Connection via Bluetooth

---

The MaxiBAS BT506 device needs to be either connected to a vehicle or to an available power source, so that it is powered up during the synchronization procedure. Make sure the tablet is fully charged or is connected to an external power supply.

➤ **To pair the BT506 tester with the tablet**

1. Turn on both the MaxiBAS BT506 and MaxiSys Elite II Pro tablet.
2. Tap **VCI Manager** on the MaxiSys Job Menu.
3. Select **BAS BT** from the connection mode list. Toggle Bluetooth **ON**. The tablet automatically scans for an available battery tester for pairing. The device name will appear as “Maxi” suffixed with a serial number.
4. Check the serial number of your BT506 tester and select the desired device on the tablet for pairing.
5. When paired successfully, the connection status will read “Connected.”

## 9.3 VCI Update

---

The Update module provides the latest update for the MaxiFlash VCI. Before updating the VCI firmware, please make sure your tablet network is stable.

➤ **To update the VCI**

1. Power on the tablet.
2. Connect the VCI to the tablet via USB cable or Bluetooth.
3. Tap **VCI Manager** on the MaxiSys Job Menu.
4. Select **VCI Update** from the connection mode list.
5. The current version and the latest version of the VCI will appear. Tap **Update Now** to update the VCI if available.

## 9.4 BAS Update

---

The BAS Update module provides the latest update for the MaxiBAS BT506. Before updating the BT506 tester, please make sure your tablet network is stable.

➤ **To update the MaxiBAS BT506**

1. Power on the tablet and the MaxiBAS BT506.
2. Connect the MaxiBAS BT506 device to the tablet via Bluetooth or USB cable.
3. Tap **VCI Manager** on the MaxiSys Job Menu.
4. Select **BAS Update** from the connection mode list.
5. The current version and the latest version of the MaxiBAS BT506 will appear. Tap **Update Now** to update the MaxiBAS BT506 if available.

---

 **NOTE**

Do not leave the BAS Update page during upgrade.

---

# 10 Update

The Update application allows you to download the latest software. The updates can improve the MaxiSys applications' capabilities, typically by adding new tests, new vehicle models or enhanced applications.

This section describes the update operations for the MaxiSys tablet. The tablet automatically searches for available updates for all of the MaxiSys software when it is connected to the Internet. Any updates that are found can be downloaded and installed on the tablet with a stable Internet connection.



---

## NOTE

Make sure the tablet is registered before activating the Update application. See [Autel User Center](#) for details.

---

### ➤ To update the software

1. Power up the tablet, and ensure that it is connected to a power source and has a steady Internet connection.
2. Tap the **Update** application button from the MaxiSys Job Menu. The Update application screen displays.
3. On the Update screen, tap the **Get** button to update the specific item(s) or tap the **Update All** button to update all available items.
4. Tap **More** to view the details of all the available updates. You can also tap the **Get** or **Update All** button for update.
5. During the update, tap the  icon to suspend the updating process. Tap the  icon to resume the update and the process will continue from the pause point.
6. When the updating process is completed, the software will be installed automatically. The new version will replace the older version.

---

## NOTE

For the account management, proceed to the Member Center tab.

---

# 11 Support

This application launches the Support platform which synchronizes Autel's online service base station with the MaxiSys tablet. Connected to Autel's service channel and online communities, the Support application provides the quickest way for problem solutions, allowing you to send help requests to obtain direct service and support.

## 11.1 Support Screen Layout

---

The Support application interface is navigated by the **Home** button on the top navigation bar.

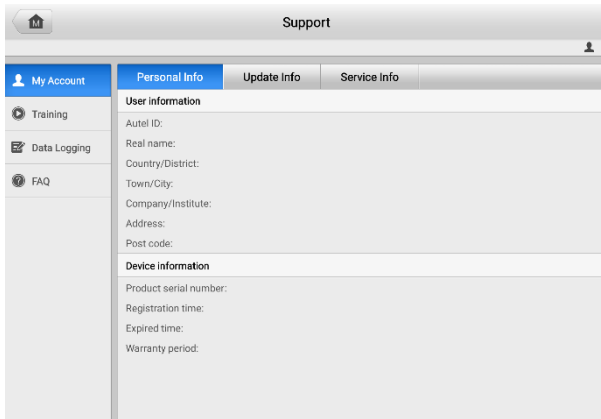

**Figure 11-1 Support Application Screen**

The main section of the Support screen is divided into two sections. The narrow column on the left is the main menu; selecting one subject from the main menu displays the corresponding functional interface on the right.

## 11.2 My Account

---

The My Account screen displays the comprehensive information of the user and the product, which is synchronized with the online registered account, including User Info, Device Info, Update Info, and Service Info.

## 11.2.1 Personal Info

The User Information and Device Information are both included under the Personal Info section.

- **User Information** — displays detailed information of your registered online Autel account, such as your Autel ID, name, address and other contact information.
- **Device Information** — displays the registered product information, including the serial number, registration date, expire date, and warranty period.

## 11.2.2 Update Info

The Update Info section displays a detailed list of the product's software update history, including the product serial number, software version or name, and the update time.

## 11.2.3 Service Info

The Service Info section displays a detailed record list of the device's service history information. Every time the device has been sent back to Autel for repair, the device's serial number and other information, such as the fault type, changed components, or system reinstallation will be recorded and updated to the associated online product account that will be synchronized to the Service Info section.

## 11.3 Training

---

The Training section provides quick links to Autel's online video accounts. Select a video channel by language to see all available Autel online tutorial videos on such topics as product usage techniques and vehicle diagnostics practices.

## 11.4 Data Logging

---

The Data Logging section keeps records of all **Feedback** (submitted), **Not Feedback** (but saved) or **History** (up to the latest 20 test records) data loggings on the diagnostics system. The support personnel will receive and process the submitted reports through the Support platform. The solution will be sent back within 48 hours. You may continue to correspond with Support until the issue is resolved.

➤ **To issue a reply in a Data Logging section**

1. Tap the **Feedback** tab to view the submitted data loggings.
2. Select the latest message from Autel Tech Support service.



3. Tap the input field at the bottom of the screen and enter your reply. Additionally, you may tap the **Audio** button to record a voice message or tap the **Camera** button to take a screenshot.
4. Tap **Send** to send your reply to Support.

## 11.5 FAQ Database

---

The FAQ section provides comprehensive references for all questions frequently asked and answered about the use of Autel's online member account, shopping, and payment procedures.

- Account — displays questions and answers about the use of Autel's online user account.
- Shopping & Payment — displays questions and answers about online product purchase and payment methods or procedures.

# 12 MaxiViewer

MaxiViewer allows you to search the functions supported by our tools and the version information. There are two ways of searching, either by searching the tool and the vehicle or searching the functions.

➤ **To search by vehicle**

1. Tap the **MaxiViewer** application on the MaxiSys Job Menu.
2. Tap the tool name on the top-left to drop down the tool list, and tap the one you want to search.
3. Choose the vehicle brand, model, and year you want to search.

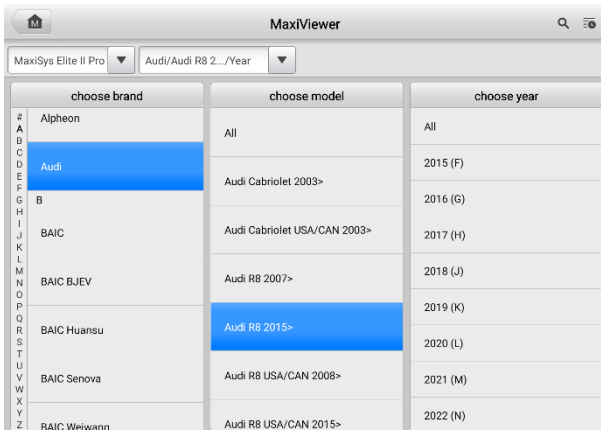

**Figure 12-1 MaxiViewer Screen**

4. All the functions supported by the selected tool for the selected vehicle are displayed such as vehicle's system, function, sub function, version, and more.

➤ **To search by the functions**

1. Tap the MaxiViewer application on the MaxiSys Job Menu.
2. Tap the tool name on the top-left to drop down the tool list, and choose the one you want to search.
3. Enter the function you want to search in the top-right search box. The screen will display all vehicles that support this function, along with information such as the vehicles' year, system, capacity, type, series, function, sub-function, and version.

# 13 MaxiScope

The MaxiScope application configures the MaxiSys Diagnostics Device to operate as an automotive oscilloscope when used in combination with the MaxiScope module. This function provides all the features needed for performing electrical and electronic circuit tests as well as monitoring signal activities on any modern vehicles, which shows you what is really going on with a vehicle's electrical system.

Please download the latest user manual for Autel MaxiScope device from [www.autel.com](http://www.autel.com) > **Specialty Tools** > **MORE PRODUCTS** > **MaxiScope MP408** > **Downloads**.

# 14 MaxiVideo

The MaxiVideo application configures the MaxiSys tablet to operate as a digital video scope by simply connecting the tablet to a MaxiVideo camera. This function allows you to examine difficult-to-reach areas normally hidden from sight, with the ability to record digital still images and videos, which offers you an economical solution to inspect machinery, facilities, and infrastructure in a safe and quick way.

---

## NOTE

1. The MaxiVideo camera and its fittings are additional accessories, and need to be purchased separately. Both sizes (8.5 mm and 5.5 mm) of the imager head are optional and available for purchase.
  2. This function is compatible with the MaxiVideo camera in models MV105S, MV108S, MV105, and MV108.
  3. Connect the tablet with MaxiVideo camera using the USB cable. For detailed operation instructions, please refer to the Quick Reference Guide for the MaxiVideo camera.
-

# 15 Quick Link

The Quick Link application provides you with convenient access to Autel's official website and many other well-known sites in automotive service, which offers you abundant information and resources, such as technical help, knowledge bases, forums, training, and expert consultations.

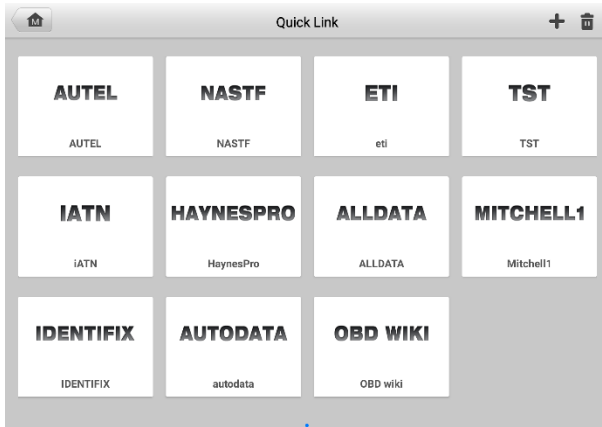

**Figure 15-1 Quick Link Screen**

➤ **To open a quick link**

1. Tap **Quick Link** on the MaxiSys Job Menu. The Quick Link screen appears.
2. Select a website thumbnail from the main section. The browser is launched and the selected website is opened.
3. Now you can start exploring the website.

➤ **To manage the quick links**

1. Tap **Quick Link** on the MaxiSys Job Menu. The Quick Link application screen displays.
2. Tap the **+** icon on the upper-right corner to add websites. Tap the **🗑️** icon to delete websites.

# 16 Remote Desktop

The Remote Desktop application launches the TeamViewer Quick Support program, which is a simple, fast, and secure remote control interface. You can use the application to receive ad-hoc remote support from Autel's support center, colleagues or friends, by allowing them to control your MaxiSys tablet on their PC via the TeamViewer software.

## 16.1 Operations

---

If you think of a TeamViewer connection as a phone call, the TeamViewer ID would be the phone number, under which all TeamViewer clients can be reached separately. Computers and mobile devices that run TeamViewer are identified by a globally unique ID. The first time the Remote Desktop application is started, this ID is generated automatically based on the hardware characteristics and will not change.

Make sure the tablet is connected to the Internet before launching the Remote Desktop application, so that the tablet is able to receive remote support from a third party.

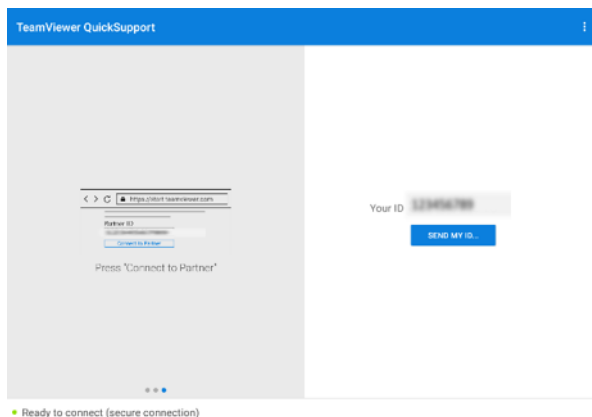

**Figure 16-1 Remote Desktop Screen**

➤ **To receive remote support from a partner**

1. Power on the tablet.
2. Tap the **Remote Desktop** application on the MaxiSys Job Menu. The TeamViewer interface appears and the device ID is generated and displayed.
3. Your partner must install the Remote Control software to their computer by downloading the TeamViewer program (full version) online

(<http://www.teamviewer.com>). Start the software on their computer at the same time in order to provide support and take control of the tablet remotely.

4. Provide your ID to the partner, and wait for them to send you a remote control request.
5. A message displays to ask for your confirmation to allow remote control on your device.
6. Tap **Allow** to accept, or tap **Deny** to reject.

# 17 User Feedback

The User Feedback feature allows you to submit questions related to this product.

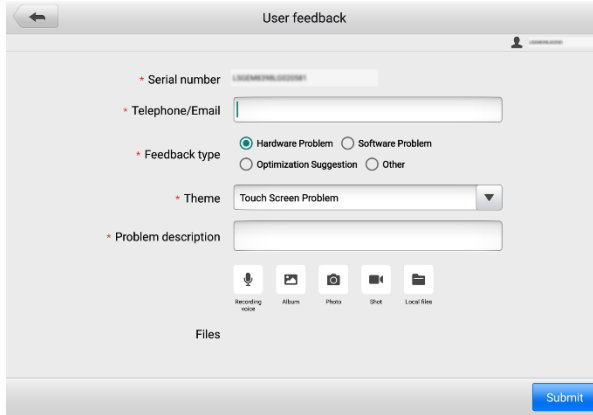
The image shows a mobile application screen titled "User feedback". At the top left is a back arrow icon, and at the top right is a user profile icon. The form contains several fields: "Serial number" with a text input field; "Telephone/Email" with a text input field; "Feedback type" with four radio button options: "Hardware Problem" (selected), "Software Problem", "Optimization Suggestion", and "Other"; "Theme" with a dropdown menu showing "Touch Screen Problem"; and "Problem description" with a text input field. Below these fields are five icons for file attachments: "Recording voice", "Album", "Photo", "Shot", and "Local file". A "Files" label is positioned below the icons. At the bottom right corner, there is a blue "Submit" button.

**Figure 17-1 User Feedback Screen**

## ➤ To send new user feedback

1. Register the product online, see [Autel User Center](#) for detailed information.
2. Tap **User Feedback** on the MaxiSys Job Menu. The device information is automatically synchronized with the online account.
3. Enter your telephone number/email address, feedback type, theme, and problem description. You can also attach a voice recording, photo, photo album, screen captures, image or PDF files with the form. To help resolve the issue efficiently, we recommend you to complete the form with as many details as possible.
4. Tap **Submit** to send the completed form to Autel's online service center. The submitted feedback will be carefully read and handled by our support personnel.



# 18 Autel User Center

The Autel User Center application allows you to register your tool to download the latest released software, thereby enhancing the functionality of the MaxiSys application by adding new vehicle models or enhanced applications to the database.

There are two ways for product registration:

A. Register the product using the MaxiSys tablet

➤ **To log in with your account and register your tool**

1. Tap **Autel User Center** from the MaxiSys Job Menu. The following screen displays.

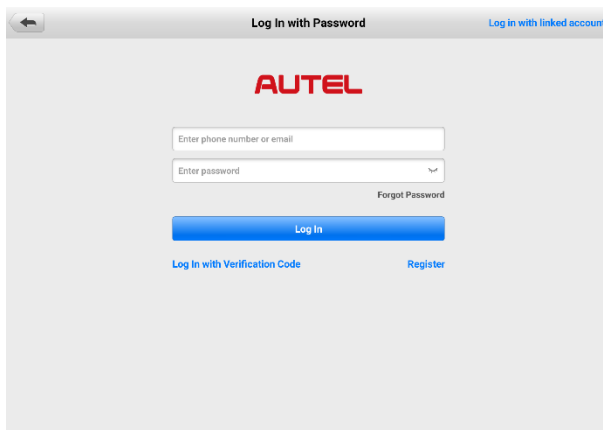

**Figure 18-1 Autel User Center Screen**

2. If you already have an Autel ID, you can log in with your phone number and verification code, or tap **Log In with Password** to log in with your Autel ID and password. If you do not have an Autel ID yet, tap **Register** to create an Autel ID.
3. Once your account is successfully registered, you will enter the main menu of the Autel User Center.
4. Select **Device Management** on the main menu.
5. Tap the **Link Device** button on the upper-right corner of the Device Management screen. The serial number and password of the device will automatically appear on the Link Device screen.
6. Tap the **Link** button to complete the product registration.

## B. Register the product on the Autel website

### ➤ **To register the diagnostics device**

1. Visit the website: [pro.autel.com](http://pro.autel.com).
2. If you have an Autel account, log in and skip to Step 7.
3. If you are a new member to Autel, click **Register** to create your Autel ID.
4. Enter your personal information. Fields marked with an asterisk (\*) are mandatory.
5. After all the mandatory information is entered, read the **Autel User Service Agreement** and **Autel Privacy Policy**, then check the box to accept the terms and click **Register**.
6. Once your account is successfully registered, you will be redirected to the Product Registration screen. If not, click the button on the screen.
7. Your product serial number and password are required to enter. To find your serial number and password on the tablet: go to **Settings** > **About**.
8. Enter your tablet's serial number and password.
9. Enter the CAPTCHA code and click **Submit** to complete your product registration.

# 19 Maintenance and Service

To ensure that the tablet and the combined VCI unit perform at their optimum level, we advise that the product maintenance instructions in this section are strictly followed.

## 19.1 Maintenance Instructions

---

The following includes instructions on how to maintain your devices, together with precautions to take.

- Use a soft cloth dampened with alcohol or mild glass cleaner to clean the tablet touchscreen at the end of each work day.
- Do not use any abrasive cleansers, detergent, or automotive chemicals on the tablet.
- Keep the devices in dry conditions and within specified operating temperatures.
- Dry your hands before using the tablet. The touchscreen of the tablet may not work when it is moist, or when you tap the touchscreen with wet hands.
- Do not store the devices in humid, dusty or dirty areas.
- Check the housing, wiring, and connectors for dirt and damage before and after each use.
- Do not attempt to disassemble your tablet or the VCI unit.
- Do not drop or cause severe impact to the devices.
- Use only authorized battery chargers and accessories. Any malfunction or damage caused by the use of unauthorized battery charger or accessories will void the limited product warranty.
- Ensure that the battery charger does not contact conductive objects.
- Do not use the tablet beside microwave ovens, cordless phones and certain medical or scientific instruments to prevent signal interference.

## 19.2 Troubleshooting Checklist

---

- A. When the tablet does not work properly:
- Make sure the tablet has been registered online.

- Make sure the system software and diagnostics application are properly updated.
  - Make sure the tablet is connected to the Internet.
  - Check all cables, connections, and indicators to see if the signal is being received.
- B.** When battery life is shorter than usual:
- This may happen when you are in an area with low signal strength. Turn off your device if it is not in use.
- C.** When you cannot turn on the tablet:
- Make sure the tablet is connected to a power source or the battery is charged.
- D.** When you are unable to charge the tablet:
- Your charger maybe out of order. Contact your nearest dealer.
  - You may be attempting to use the device in an overly hot/cold temperature. Charge the device in a temperate area.
  - Your device may not be connected to the charger properly. Check the connector.

---

 **NOTE**

If the problems persist, please contact Autel's technical support personnel or your local selling agent.

---

## 19.3 About Battery Usage

---

Your tablet is powered by a built-in lithium-ion polymer battery, which enables you to recharge your battery when there is electricity left.

 **DANGER**

The built-in lithium-ion polymer battery is factory-replaceable only; incorrect replacement or tampering with the battery pack may cause an explosion.

---

- Do not use a damaged battery charger.
- Do not disassemble, open, crush, bend, deform, puncture, or shred the battery.
- Do not modify, remanufacture or attempt to insert foreign objects into the battery, or expose the battery to fire, explosion, or other hazards.
- Only use the specified charger and USB cables. Use of non-Autel-authorized charger or USB cables may lead to device malfunction or failure.

- Use of an unqualified battery or charger may present a risk of fire, explosion, leakage, or other hazards.
- Avoid dropping the tablet. If the tablet is dropped, especially on a hard surface, and you suspect damage, take the tablet to a service center for inspection.
- Try to keep closer to your wireless router to reduce battery usage.
- The time needed to recharge the battery varies depending on the remaining battery capacity.
- Battery life inevitably shortens over time.
- Unplug the charger once the tablet is fully charged since overcharging may shorten battery life.
- Keep the battery in temperate environments. Do not place the battery inside a car when it is too hot or too cold, which may reduce the capacity and life of the battery.

## 19.4 Service Procedures

---

This section provides information on technical support, repair service, and application for replacement or optional parts.

### 19.4.1 Technical Support

If you have any question or problem on product operations, please contact us.

#### **Autel China Headquarters**

- Phone: +86 (0755) 8614-7779 (Monday-Friday, 9AM-6PM Beijing Time)
- Email: [support@autel.com](mailto:support@autel.com)
- Address: Floor 2, Caihong Keji Building, 36 Hi-tech North Six Road, Songpingshan Community, Xili Sub-district, Nanshan District, Shenzhen City, China
- Web: [www.autel.com](http://www.autel.com)

#### **Autel North America**

- Phone: 1-855-288-3587 (Monday-Friday, 9AM-6PM Eastern Time)
- Email: [ussupport@autel.com](mailto:ussupport@autel.com)
- Address: 36 Harbor Park Drive, Port Washington, New York, USA 11050
- Web: [www.autel.com/us](http://www.autel.com/us)

## **Autel Europe**

- Phone: +49(0)89 540299608 (Monday-Friday, 9AM-6PM Berlin Time)
- Email: [support.eu@autel.com](mailto:support.eu@autel.com)
- Address: Landsberger Str. 408, 81241 München, Germany
- Web: [www.autel.eu](http://www.autel.eu)

## **Autel APAC**

### **Japan:**

- Phone: +81-045-548-6282
- Email: [support.jp@autel.com](mailto:support.jp@autel.com)
- Address: 6th Floor, Ari-nadoribiru 3-7-7, Shinyokohama, Kohoku-ku, Yokohama-shi, Kanagawa-ken, 222-0033 Japan
- Web: [www.autel.com/jp](http://www.autel.com/jp)

### **Australia:**

- Email: [ausupport@autel.com](mailto:ausupport@autel.com)
- Address: Unit 5, 25 Veronica Street, Capalaba

## **Autel IMEA**

- Phone: +971 585 002709 (in UAE)
- Email: [imea-support@autel.com](mailto:imea-support@autel.com)
- Address: 906-17, Preatoni Tower (Cluster L), Jumeirah Lakes Tower, DMCC, Dubai, UAE
- Web: [www.autel.com](http://www.autel.com)

## **Autel Latin America**

### **Mexico:**

- Phone: +52 33 1001 7880 (Spanish in Mexico)
- Email: [latsupport@autel.com](mailto:latsupport@autel.com)
- Address: Avenida Americas 1905, 6B, Colonia Aldrete, Guadalajara, Jalisco, Mexico

**Brazil:**

- Email: [brsupport@autel.com](mailto:brsupport@autel.com)
- Address: Avenida José de Souza Campos nº 900, sala 32 Nova Campinas Campinas – SP, Brazil
- Web: [www.autel.com/br](http://www.autel.com/br)

## 19.4.2 Repair Service

If it is necessary to send back your device for repair, please download and fill out the repair service form from [www.autel.com](http://www.autel.com). The following information must be included:

- Contact name
- Return address
- Telephone number
- Product name
- Complete description of the problem
- Proof-of-purchase for warranty repairs
- Preferred method of payment for non-warranty repairs

---

 **NOTE**

For non-warranty repairs, payment can be made with Visa, Master Card, or with approved credit terms.

---

**Send the device to your local agent, or to the address below:**

Floor 2, Caihong Keji Building, 36 Hi-tech North Six Road, Songpingshan Community, Xili Sub-district, Nanshan District, Shenzhen City, China

## 19.4.3 Other Services

You can purchase the accessories directly from authorized tool suppliers of Autel, or your local distributor or agent.

Your purchase order should include the following information:

- |                        |                     |
|------------------------|---------------------|
| ● Contact information  | ● Item description  |
| ● Product or part name | ● Purchase quantity |

# 20 Compliance Information

## FCC Compliance

FCC ID: WQ8-MS908S2122

This equipment has been tested and verified to comply with the limits for a Class B digital device, pursuant to Part 15 of the FCC Rules. These limits are designed to provide reasonable protection against harmful interference in a residential installation. This equipment generates uses and can radiate radio frequency energy and, if not installed and used in accordance with the instructions, may cause harmful interference to radio communications. However, there is no guarantee that interference will not occur in a particular installation. If this equipment does cause harmful interference to radio or television reception, which can be determined by turning the equipment off and on, the user is encouraged to correct the interference by one or more of the following measures:

- Reorient or relocate the receiving antenna.
- Increase the separation between the equipment and receiver.
- Consult the dealer or an experienced radio/TV technician for help.

This device complies with part 15 of the FCC Rules. Operation is subject to the following two conditions:

- (1) This device may not cause harmful interference, and
- (2) This device must accept any interference received, including interference that may cause undesired operation.

Changes or modifications not expressly approved by the party responsible for compliance could void the user's authority to operate the equipment.

### SAR:

The radiated output power of this device is below the FCC radio frequency exposure limits. Nevertheless, the device should be used in such a manner that the potential for human contact is minimized during normal operation.

The exposure standard for wireless devices employs a unit of measurement known as the Specific Absorption Rate, or SAR. The SAR limit set by the FCC is 1.6 W/Kg. Tests for SAR are conducted using standard operating positions accepted by the FCC with the device transmitting at its highest certified power level in all tested frequency bands. Although the SAR is determined at the highest certified power level, the actual SAR level of the device while operating can be well below the maximum value. This is because the device is designed to operate at multiple power levels to use only the power required to



reach the network. To avoid the possibility of exceeding the FCC radio frequency exposure limits, human proximity to antenna should be minimized.

### **RoHS Compliance**

This device is declared to be in compliance with the European RoHS Directive 2011/65/EU.

### **CE Compliance**

This product is declared to conform to the essential requirements of the following directives and carries the CE mark accordingly:

Radio Equipment Directive 2014/53/EU.

# 21 Warranty

## 21.1 12-month Limited Warranty

---

Autel Intelligent Technology Corp., Ltd. (the Company) warrants to the original retail purchaser of this MaxiSys Diagnostics Device that should this product or any part thereof during normal usage and under normal conditions be proven defective in material or workmanship that results in product failure within twelve (12) months period from the date of purchase, such defect(s) will be repaired, or replaced (with new or rebuilt parts) with Proof of Purchase, at the Company's option, without charge for parts or labor directly related to the defect(s).

---

### NOTE

If the warranty period is inconsistent with local laws and regulations, please comply with the relevant local laws and regulations.

---

The Company shall not be liable for any incidental or consequential damages arising from the use, misuse, or mounting of the device. Some states do not allow limitation on how long an implied warranty lasts, so the above limitations may not apply to you.

This warranty does not apply to:

- a) Products subjected to abnormal use or conditions, accident, mishandling, neglect, unauthorized alteration, misuse, improper installation or repair or improper storage;
- b) Products whose mechanical serial number or electronic serial number has been removed, altered or defaced;
- c) Damage from exposure to excessive temperatures or extreme environmental conditions;
- d) Damage resulting from connection to, or use of any accessory or other product not approved or authorized by the Company;
- e) Defects in appearance, cosmetic, decorative or structural items such as framing and non-operative parts.
- f) Products damaged from external causes such as fire, dirt, sand, battery leakage, blown fuse, theft or improper usage of any electrical source.

---

### IMPORTANT

All contents of the product may be deleted during the process of repair. You should create a back-up copy of any contents of your product before delivering the product for warranty service.

---

**AUTEL<sup>®</sup>**