

USER MANUAL

AUTEL[®]

MaxiIM KM100E

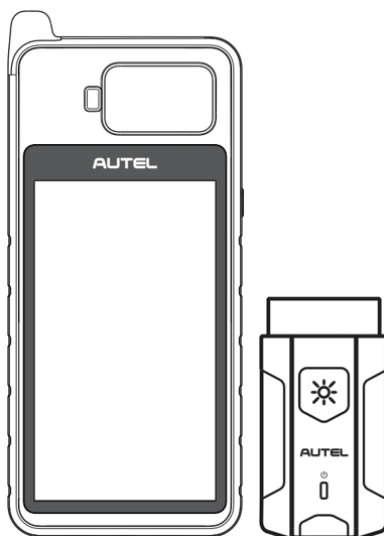

Trademarks

Autel®, MaxiIM®, MaxiCOM®, MaxiDAS®, MaxiScan®, MaxiTPMS®, MaxiRecorder®, and MaxiCheck® are trademarks of Autel Intelligent Technology Corp., Ltd., registered in China, the United States and other countries. All other marks are trademarks or registered trademarks of their respective holders.

Copyright Information

No part of this manual may be reproduced, stored in a retrieval system or transmitted, in any form or by any means, electronic, mechanical, photocopying, recording, or otherwise without the prior written permission of Autel.

Disclaimer of Warranties and Limitation of Liabilities

All information, specifications and illustrations in this manual are based on the latest information available at the time of printing. Autel reserves the right to make changes at any time without notice. While information of this manual has been carefully checked for accuracy, no guarantee is given for the completeness and correctness of the contents, including but not limited to the product specifications, functions, and illustrations.

Autel will not be liable for any direct damages or for any special, incidental, or indirect damages or for any economic consequential damages (including the loss of profits).

! **IMPORTANT:** Before operating or maintaining this unit, please read this manual carefully, paying extra attention to the safety warnings and precautions.

For Services and Support:



pro.autel.com

www.autel.com



+86 (0755) 8614-7779

Safety Information

For your own safety and the safety of others, and to prevent damage to the device and vehicles upon which it is used, it is important that the safety instructions presented throughout this manual be read and understood by all persons operating or coming into contact with the device.

There are various procedures, techniques, tools, and parts for servicing vehicles, as well as the skill of the person doing the work. Because of the vast number of test applications and variations in the products that can be tested with this equipment, we cannot possibly anticipate or provide advice or safety messages to cover every circumstance. It is the automotive technician's responsibility to be knowledgeable of the system being tested. It is crucial to use proper service methods and test procedures. It is essential to perform tests in an appropriate and acceptable manner that does not endanger your safety, the safety of others in the work area, the device being used, or the vehicle being tested.

Before using the device, always refer to and follow the safety messages and applicable test procedures provided by the manufacturer of the vehicle or equipment being tested. Use the device only as described in this manual. Read, understand, and follow all safety messages and instructions in this manual.

Safety Messages

Safety messages are provided to help prevent personal injury and equipment damage. All safety messages are introduced by a signal word indicating the hazard level.

 **DANGER:** Indicates an imminently hazardous situation which, if not avoided, will result in death or serious injury to the operator or to bystanders.

 **WARNING:** Indicates a potentially hazardous situation which, if not avoided, could result in death or serious injury to the operator or to bystanders.

Safety Instructions

The safety messages herein cover situations Autel is aware of. Autel cannot know, evaluate or advise you as to all of the possible hazards. You must be certain that any condition or service procedure encountered does not jeopardize your personal safety.



DANGER: When an engine is operating, keep the service area **WELL VENTILATED** or attach a building exhaust removal system to the engine exhaust system. Engines produce carbon monoxide, an odorless, poisonous gas that causes slower reaction time and can lead to serious personal injury or loss of life.



Do Not Turn the Volume Up Too Loud When Using Headphones

Listening at high volumes that over-stimulate the ear for long periods of time may result in loss of hearing.



SAFETY WARNINGS:

- Always perform automotive testing in a safe environment.
- Wear safety eye protection that meets ANSI standards.
- Keep clothing, hair, hands, tools, test equipment, etc., away from all moving or hot engine parts.
- Operate the vehicle in a well-ventilated work area.
- Put the transmission in **PARK** (for automatic transmission) or **NEUTRAL** (for manual transmission) and make sure the parking brake is engaged.
- Put blocks in front of the drive wheels and never leave the vehicle unattended while testing.
- Be extra cautious when working around the ignition coil, distributor cap, ignition wires and spark plugs. These components create hazardous voltages when the engine is running.
- Keep a fire extinguisher suitable for gasoline, chemical, and electrical fires nearby.
- Do not connect or disconnect any test equipment while the ignition is on or the engine is running.

- Keep the test equipment dry, clean, and free from oil, water, and grease. Use a mild detergent on a clean cloth to clean the outside of the equipment as necessary.
- Do not drive the vehicle and operate the test equipment at the same time. Any distraction may cause an accident.
- Refer to the service manual for the vehicle being serviced and adhere to all diagnostic procedures and precautions. Failure to do so may result in personal injury or damage to the test equipment.
- To avoid damaging the test equipment or generating false data, make sure the vehicle battery is fully charged and the connection to the vehicle DLC is clean and secure.
- Do not place the test equipment on the distributor of the vehicle. Strong electro-magnetic interference can damage the equipment.
- Do not place the device in a strong electromagnetic environment for strong electromagnetic interference may damage the device.

CONTENTS

Safety Information	ii
1. Using This Manual	1
1.1 Conventions	1
2. General Introduction	3
2.1 MaxiIM KM100E	3
2.2 MaxiVCI V200 — Vehicle Communication Interface	6
3. Getting Started	9
3.1 Powering Up	9
3.2 Powering Down	13
4. Universal Key	14
4.1 Confirm Vehicle Information	14
4.2 Operation	17
5. Reading/Cloning	18
5.1 Transponder Reading	18
5.2 Transponder Cloning	19
5.3 Transponder Editing	21
6. Transponder Function	23
6.1 Transponder Generation	23
6.2 Transponder Simulation	25
6.3 Conversion between ID63 and ID83	27
7. Frequency Detection	28
8. IMMO	29

8.1 Getting Started	29
8.2 Vehicle Identification	30
8.3 IMMO Screen Layout	32
8.4 Screen Messages.....	33
8.5 Making Selections	34
8.6 IMMO	34
9. Special Functions	42
9.1 IMMO Data Processing	42
9.2 Key Unlocking	45
9.3 Toyota Smart Unlocking	47
9.4 Universal Key Information Detection	47
9.5 Button Customization	48
9.6 Ignition Coil Detection	49
10. Settings.....	51
10.1 Market	51
10.2 Feedback.....	51
10.3 VCI Manager	52
10.4 System Settings	55
10.5 Units	55
10.6 About.....	56
11. Updates.....	57
12. Data Manager.....	59
12.1 Test Records	59
12.2 Workshop Information	60

12.3 Image	61
12.4 PDF	62
12.5 Uninstall Apps	62
12.6 Data Logging.....	62
13. Remote Desktop.....	64
14. Tool Registration.....	66
15. Academy	67
16. Maintenance and Service	68
16.1 Maintenance Instructions	68
16.2 Troubleshooting Checklist	69
16.3 About Battery Usage	69
16.4 Service Procedures.....	70
17. Compliance Information	73
18. Warranty	75
18.1 Limited One-Year Warranty.....	75

1. Using This Manual

This manual contains device usage instructions.

Some illustrations shown in this manual may contain modules and optional equipment that are not included in your system. Contact your sales representative for availability of other modules and optional tools or accessories.

1.1 Conventions

The following conventions are used.

1.1.1 Bold Text

Bold text is used to highlight selectable items such as buttons and menu options.

Example:

- Tap **OK**.

1.1.2 Notes

A **NOTE** provides helpful information such as additional explanations, tips, and comments.

1.1.3 Important

IMPORTANT indicates a situation which, if not avoided, may result in damage to the test equipment or vehicle.

1.1.4 Hyperlinks

Hyperlinks or links that take you to other related articles, procedures, and illustrations are available in electronic documents. Blue italic colored text indicates a selectable hyperlink.

1.1.5 Procedures

An arrow icon indicates a procedure.

- **To power down the tool**
 1. Press and hold the **Power/Lock** button.
 2. Tap **Power off**.
 3. Tap **OK**. The tool will turn off in a few seconds.

2. General Introduction

The MaxiIM KM100E is a professional intelligent key tool that integrates such functions as universal key generation, transponder reading/cloning, and IMMO learning in a compact and easy-to-use design. Equipped with the MaxiVCI V200 vehicle communication interface device, this professional key tool easily offers you one-stop service from universal key generation to key learning. It is undoubtedly an ideal choice for professional locksmiths.

2.1 MaxiIM KM100E

2.1.1 Product Overview

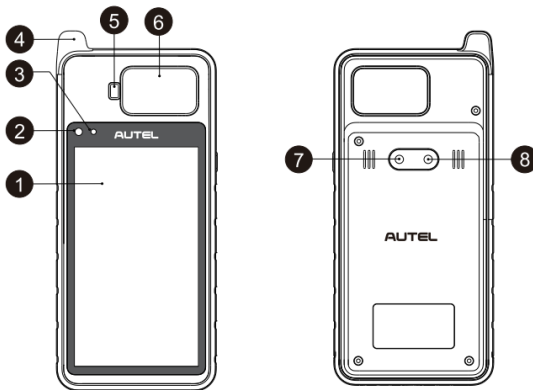

Figure 2-1 KM100E Front/Back View

1. 5.5-inch Touchscreen
2. Ambient Light Sensor — detects ambient brightness
3. Status LED
4. Low Frequency Detection Collector — collects low frequency data
5. Transponder Slot — reads and writes transponder

6. Vehicle Key Slot — reads key information and measures remote frequency
7. Rear Camera
8. Camera Flash

Camera

Function Description: Used for vehicle information identification, such as VIN scanning and vehicle photography.

Privacy Impact: Collects vehicle VIN data and uploads it to the cloud platform to identify the vehicle model, year, engine type, etc.

Permission Control: Camera access permissions can be disabled in system settings (Path: Settings > System Settings > More > App & notifications > App permissions > Camera).

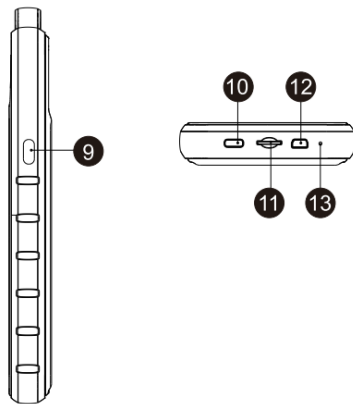

Figure 2-2 KM100E Side/Bottom View

9. Power/Lock Button — press and hold to turn on/off the tool, or tap to lock the screen
10. Type-C USB Port (also an OTG port)
11. SD Card Slot
12. Mini USB Port
13. Microphone

Microphone

Function Description: Used for audio and video recording through the device and its camera.

Privacy Impact: Stores recorded voice data from the recorder and camera locally.

Permission Control: Microphone access permissions can be disabled in system settings (Path: Settings > System Settings > More > App & notifications > App permissions > Microphone).

2.1.2 Power Sources

The key tool can receive power from the following sources:

- Internal battery pack
- AC/DC power supply

! IMPORTANT

Do not charge the battery when the temperature is below 0 °C (32 °F) or above 45 °C (113 °F).

Internal Battery Pack

The key tool can be powered by the internal rechargeable battery.

AC/DC Power Supply — Using the Power Adapter

The key tool can be powered from an electrical outlet using the AC/DC power adapter. The AC/DC power supply also charges the internal battery pack.

2.1.3 Technical Specifications

Item	Description
Display	5.5-inch touchscreen with 1280 x 720P resolution
Operation System	Android™ 9.0
Processor	Rockchip PX30 4 x ARM Cortex-A35 (1.5 GHz)
Memory	2 GB RAM + 64 GB Flash
Connectivity	<ul style="list-style-type: none">● Wi-Fi● Bluetooth● USB 2.0, Type-C

Item	Description
Sensor	Ambient light sensor
Audio Output	Beep
Internal Battery	3.85 V/4950 mAh lithium-polymer battery
Power Input	5 V/2 A
Operating Temp.	0 to 50 °C (32 to 122 °F)
Storage Temp.	-10 to 60 °C (14 to 140 °F)
Dimension (L x W x H)	200 x 89 x 22 mm
Weight	352.7 g (0.78 lb.)

2.2 MaxiVCI V200 — Vehicle Communication Interface

2.2.1 Product Overview

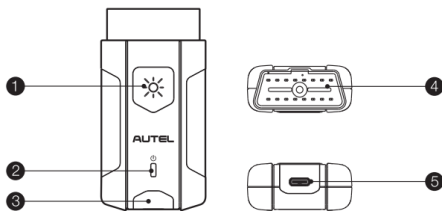

Figure 2-3 MaxiVCI V200 Views

1. Flashlight Button
2. Power LED
3. Vehicle/Connection LED
4. Vehicle Data Connector (16-pin)
5. USB Port

Table 2-1 VCI LED Description

LED	Color	Description
Power LED	Yellow	The VCI is powered on and performing self-check.
	Green	The VCI is ready for use.
	Flashing Red	The firmware is upgrading.
Vehicle/ Connection LED	Green	Solid Green: The VCI is connected via USB cable. Flashing Green: The VCI is communicating via USB cable.
	Blue	Solid Blue: The VCI is connected via Bluetooth. Flashing Blue: The VCI is communicating via Bluetooth.

2.2.2 Power Sources

The MaxiVCI V200 can receive power from the following sources:

- Vehicle power
- AC/DC power supply

Vehicle Power

The VCI device operates on 12 or 24 V vehicle power, which receives power via the vehicle data connection port. The device powers on whenever it is connected to an OBDII/EOBD compliant data link connector (DLC).

AC/DC Power Supply — Using Power Adapter

The VCI device can be powered from an electrical outlet using the AC/DC power adapter.

2.2.3 Technical Specifications

Item	Description
Communications	BLE + EDR Type-C USB
Wireless Frequency	2.4 GHz
Input Voltage Range	8 V to 30 V DC
Supply Current	150 mA @ 12 V DC
Operating Temp.	0 to 50 °C (32 to 122 °F)
Storage Temp.	-20 to 60 °C (-4 to 140 °F)
Dimensions (L x W x H)	89.89 x 46.78 x 21 mm
Weight	70.7 g (0.156 lb.)
Built-in Battery	3.7 V Lithium Battery
Light	White LED

3. Getting Started

Ensure the key tool is sufficiently charged or is connected to a power outlet.

NOTE

The images and illustrations depicted in this manual may differ from the ones in your tool.

3.1 Powering Up

Press and hold the **Power/Lock** button on the right side of the tool to power up. The system will boot up and display the Job Menu.

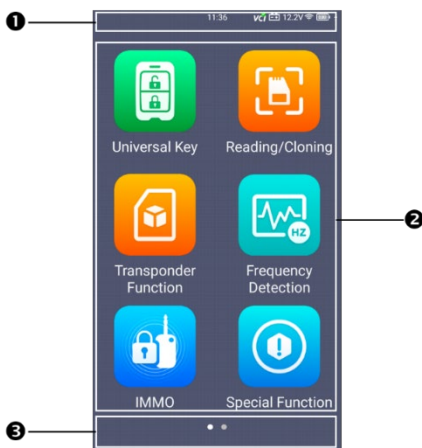









Figure 3-1 KM100E Job Menu





1. Status Bar
2. Application Buttons
3. Page Indicator

3.1.1 Application Buttons

Descriptions of the application buttons are displayed below (Table 3-1).

Table 3-1 Applications



Button	Name	Description
	Universal Key	Programs the Autel universal keys. See Universal Key .
	Reading/Cloning	Reads and clones the transponder information. See Reading/Cloning .
	Transponder Function	Performs transponder generation and simulation and conversion between ID63 and ID83. See Transponder Function .
	Frequency Detection	Detects the frequency of the smart keys. See Frequency Detection .
	IMMO	Launches the IMMO function. See IMMO .
	Special Functions	Accesses the Special Functions menu. See Special Functions .
	Settings	Allows you to set the MaxiIM system settings, and to view the general information of the tool. See Settings .
	Updates	Checks for the latest update available for the MaxiIM system, and performs updating procedures. See Updates .

Button	Name	Description
	Data Manager	Accesses the organization system for saved data files. See Data Manager .
	Remote Desktop	Configures your unit to receive remote support using the TeamViewer application program. See Remote Desktop .
	Academy	Accesses technical tutorials and training articles about the device or vehicle diagnostic techniques. See Academy .
	MaxiTools	Accesses multiple useful tools such as quick link and log collection.

3.1.2 Page Indicator and System Status Bar

Descriptions of icons on the status bar and page indicator are displayed below (Table 3-2).









Table 3-2 Page Indicator and System Status Bar Icons

Icon	Name	Description
	Page Indicator	Indicates the position of the current page when multiple pages are available. The user swipes the screen left or right to view the previous or next page.
	Voltage	Indicates the current voltage value.
	VCI Connection	A Green check mark at the top right corner indicates the VCI device is connected, while a red x indicates there is no connection.

3.1.3 System Status Icons

By swiping down, a Shortcuts Panel will appear, allowing you to adjust various system settings of the tool. The operations of each button on the panel are described in the table below (Table 3-3).

Table 3-3 System Status Icons

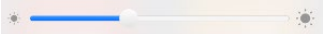
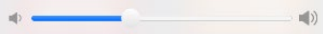
Icon	Name	Description
	Bluetooth	Enables/disables Bluetooth.
	Wi-Fi	Enables/disables Wi-Fi.
	Flashlight	Turns on/off the flashlight.
	Screenshot	Takes a screenshot of the current screen.
	Automatic Brightness	Automatically adjusts the brightness.
	Logger	Accesses the Log Collection screen.
	Restart	Restarts the tool.
	Camera	Opens the camera.
VCI	VCI Manager	Launches the VCI Manager screen.
		
Screen Brightness Slider — Slide to manually adjust the screen brightness.		
		
Volume Slider — Slide to manually adjust the volume.		

3.2 Powering Down

All vehicle communications must be terminated before powering down the tool. A warning message appears if you attempt to shut down the tool while the VCI unit is communicating with the vehicle. Forcing a power-down while communicating may lead to ECM problems on some vehicles. Exit the diagnostic function before powering down.

➤ **To power down the tool**

1. Press and hold the **Power/Lock** button.
2. Tap **Power off**.
3. Tap **OK**. The tool will turn off in a few seconds.

3.2.1 Reboot System

In case of a system crash, press and hold the **Power/Lock** button to power down the tool and restart it.

➤ **To reboot the tool**

1. Press and hold the **Power/Lock** button.
2. Tap **Restart**.
3. Tap **OK**. The tool will power off and restart.

4. Universal Key

The Universal Key function is used to program the Autel universal keys (or smart keys) for your desired vehicle model.

Prior to using the Autel universal key, make sure its battery is correctly installed.

➤ **To install the battery**

1. Place the key on a flat surface with its front side facing down.
2. Find a small slot on the side of the key. Once you locate it, gently place the flathead screwdriver inside the slot and wedge it until the casing pops out.
3. Gently remove the casing, without scratching it or damaging any interior components.
4. Place the correct battery into the correct position with the positive side of the battery facing up.
5. Place the casing back in place and gently squeeze the two pieces until they seal.

4.1 Confirm Vehicle Information

On the vehicle information screen, choose the region first. The KM100E currently supports North American and European regions. (More regions will be available soon.) Then you must fill in the vehicle information. There are two ways to fill in the information:

- Manual input
- AutoVIN

Manual Input

After choosing the manufacturer region, select your vehicle make, model, and year on the screen. Make sure that the information entered is correct.

AutoVIN

To use the AutoVIN function, you must establish vehicle communication first.

➤ **To establish vehicle communication**

1. Connect the VCI to the vehicle's OBD Data Link Connector (DLC).
2. Tap the VCI icon on the top-right corner (or in the Shortcut Panel) to enter the VCI Manager menu. The device will automatically enable Bluetooth and start searching for available pairing units. The device name will appear on this menu as "Maxi" suffixed with a serial number.
3. Check the serial number on your VCI label and select the desired device for pairing.
4. When paired successfully, the connection status reads "Paired" and the vehicle/connection LED will light solid blue.
5. The vehicle information will be automatically identified when vehicle communication is established. Confirm the vehicle information. Tap the corresponding field to manually input the correct parameters, if needed.

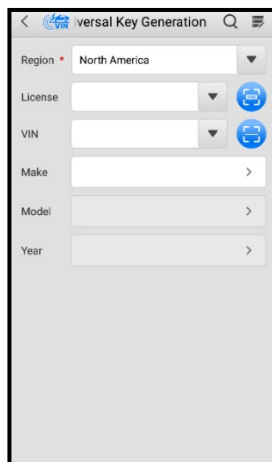









Figure 4-1 Vehicle Information Screen 1

Table 4-1 Buttons

Name	Button	Description
Back		Tap to return to the previous screen.
Exit		Tap to exit the current function and return to the MaxiM Job Menu.
Search		Tap to search for a vehicle.
Data Logging		Tap to start or stop data recording.
AutoVIN		After the VCI is connected to the device through the vehicle's OBD Data Link Connector (DLC), turn on the ignition. The vehicle's VIN number will automatically be recognized.
Scan License		Tap to scan a license plate.
Scan VIN		Tap to scan a VIN number.

The information pertaining to the key will appear at the bottom of the screen.

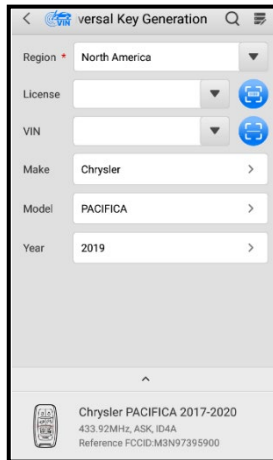

Figure 4-2 Vehicle Information Screen 2

4.2 Operation

➤ **To generate the universal key**

1. Acquire or enter the vehicle information and tap the correct key information when displayed to view detailed operation instructions.
2. First check that a battery is installed in the universal key, then place the universal key into the key slot of the tool, and tap the **Generate Universal Key** button to start generation. If the universal key is not placed correctly, a warning message will display reminding you to place the key correctly and keep it stable.
3. Keep the universal key stable in its place during key generation. You can tap the **IMMO** button to directly enter the IMMO function.

 **NOTE**

Ensure that there is only one universal key within 4 inches (10 cm) of the device's key slot to avoid signal interference.

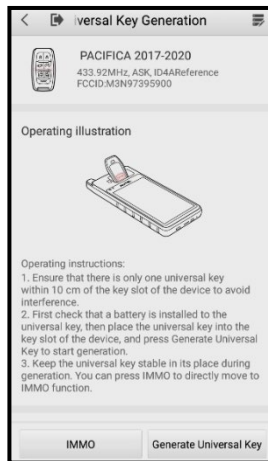

Figure 4-3 Operation Instructions Screen

Scroll down the screen to view the following help information:

1. If you need to customize button functions, use Button Customization under Special Functions.
2. Common causes for failure in universal key generation function are as below: dead battery, universal key incorrectly placed, and environmental interference, etc.

5. Reading/Cloning

The Reading and Cloning function allows you to read, clone, and edit the transponder information.

5.1 Transponder Reading

Transponder reading gives you the access to some basic information pertaining to the key, including chip type, IMMO type, transponder ID, locking status, and code mode.

To read the transponder information, place the transponder into the transponder slot or put the key into the key slot and tap the **Read** button. The Transponder Information screen will appear.

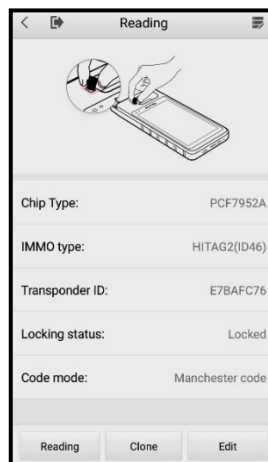

Figure 5-1 Transponder Information Screen

If a reading fails, a warning message will appear: Place the transponder into the key slot and keep it stable. If a reading fails multiple times, try to adjust the position and direction of the transponder.

After being read, the transponder can be cloned and edited.

Table 5-1 Function Buttons

Button	Description
Read	Tap to read the basic transponder information.
Clone	Tap to clone a functional transponder.
Edit	Tap to read and edit the transponder information.

5.2 Transponder Cloning

You are able to use this function to detect the transponder and vehicle information in order to decrypt a code which shall be used to directly clone and generate a functional transponder for your vehicle. The whole process saves the trouble of using the old OBD approach.

The KM100E supports various transponder types for cloning and editing. Choose the corresponding cloning procedure according to your transponder identification number (ID).

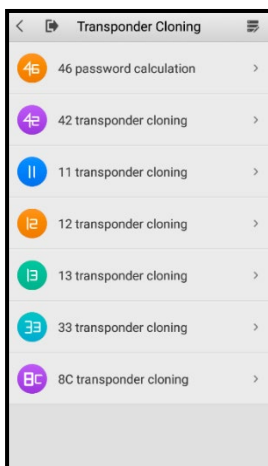

Figure 5-2 Transponder Cloning Screen

After selecting the proper transponder ID, the cloning operation instructions will appear. There also have voice prompts to remind you of the current operation stage. Follow the instructions below to complete cloning:

➤ **To clone a transponder**

1. Choose a transponder ID.
2. Place the original key into the key slot.
3. Tap the **Start** button at the bottom of the screen to start reading and cloning.

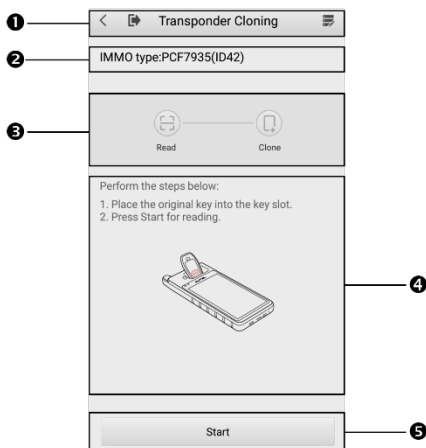

Figure 5-3 Transponder Cloning Instruction Screen

1. Upper Tool Bar. Refer to [Table 4-1 Buttons](#) for detailed description.
2. IMMO Type
3. Process Buttons — display blue when completed, otherwise, they display grey.
4. Operation Instructions and Illustration
5. Function Button

Table 5-2 Function Buttons

Buttons	Description
Start	Tap to initiate an operation.
Cancel	Tap to cancel an operation.
Retry	Tap to retry an operation when an operation failure message pops up.
Next	Tap to move to the next step.
Continue	Tap to proceed to another operation.

If the cloning process is successful, there will be a “cloning completed” message displayed on the screen. Tap the **Continue** button to advance to the next function.

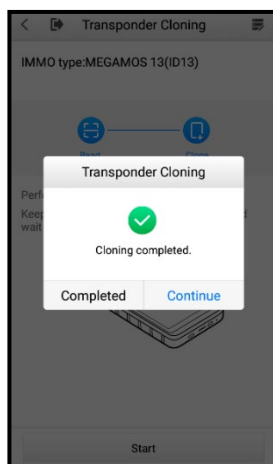

Figure 5-4 Transponder Cloning Completed Screen

5.3 Transponder Editing

This function helps you read and edit transponder information such as its configurations and EEPROM data. Choose an IMMO type (which can be accessed by the transponder reading function) and start editing according to your needs.

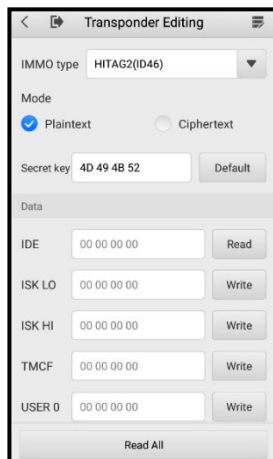

Figure 5-5 Transponder Editing Screen

When a writing operation is done successfully, a “writing succeeded” message will appear, and you may move to another operation.

6. Transponder Function

The Transponder Function allows you to perform transponder generation, transponder simulation, and conversion between ID63 and ID83.

6.1 Transponder Generation

With transponder generation, you can generate a transponder accommodating different protocols or models using a blank transponder.

Firstly, choose a vehicle make by one of the following methods:

- Vehicle Search
- Transponder Search

With Vehicle Search, you are able to directly select a vehicle to enter the transponder generation screen. Make sure you have selected the correct vehicle before generating the transponder.

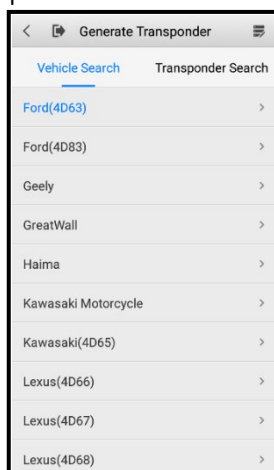

Figure 6-1 Vehicle Search Screen

With Transponder Search, you need the transponder ID available. After choosing a transponder ID, the corresponding vehicle make will appear. Tap the vehicle make to enter the Generate Transponder screen.



Figure 6-2 Transponder Search Screen

➤ **To generate a transponder**

1. Select a vehicle make.
2. Place the transponder into the transponder slot.
3. Tap the **Generate Transponder** button to start generating.

After the transponder is successfully generated, you should have a functional transponder.

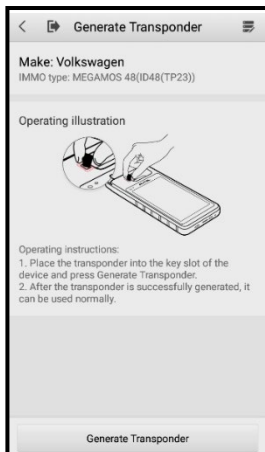

Figure 6-3 Transponder Generation Screen

6.2 Transponder Simulation

The Transponder Simulation function can be used to simulate the KM100E as a transponder using a variety of IMMO protocols. This function is particularly useful when your vehicle needs emergency start or such.

➤ **To perform a transponder simulation**

1. Choose a transponder ID. A total of six IDs are available for simulation: ID46, ID47, ID48, ID49, ID4A, and ID8A. Or you can search a transponder ID in the search box.

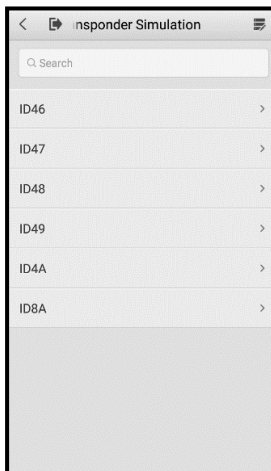

Figure 6-4 Transponder Simulation Screen

2. Enter the parameters of each register. P "x" represents register page x. Tap the **Simulate** button at the bottom of the screen to start the simulation.

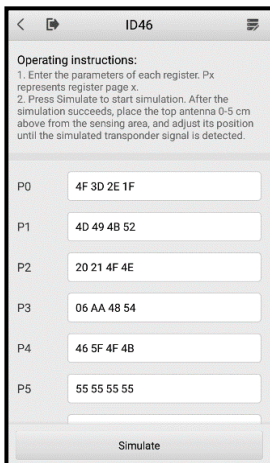

Figure 6-5 Entering the Registers Screen

- After the simulation succeeds, place the low frequency detection collector (or top antenna) no more than 2 inches (5 cm) above the inductive area, and adjust its position until the simulated transponder signal is detected.

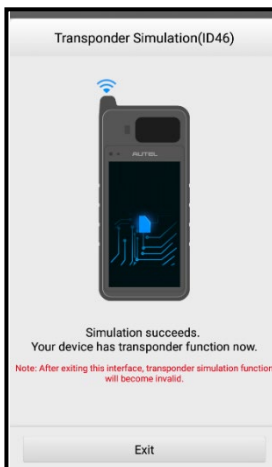

Figure 6-6 Simulation Successful Screen

After the simulation is successful, your KM100E can now work as a transponder. Tap the **Exit** button at the bottom of the screen to quit this function.

NOTE

After exiting this interface, the transponder simulation will become invalid.

6.3 Conversion between ID63 and ID83

This function is especially designed for the conversion between two types of Ford transponder — ID63 and ID83. The conversion works both ways.

- **To perform the conversion between ID63 and ID83**
 1. Place the transponder into the transponder slot and keep it stable.
 2. Tap the **Start Conversion** button at the bottom of the screen to initiate the operation.

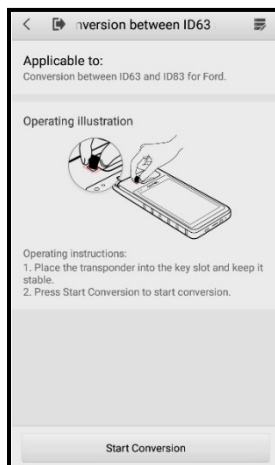

Figure 6-7 Conversion between ID63 and ID83 Screen

7. Frequency Detection

The Frequency Detection function supports smart key frequency detection for a wide range of vehicle models. The operation instructions and frequency data will display on the screen in both text and graph forms.

- **To detect the frequency of a smart key:**
 1. Place your smart key near the key slot (no more than 4 inches/10 cm).
 2. Press any button on your smart key to start detecting its frequency.

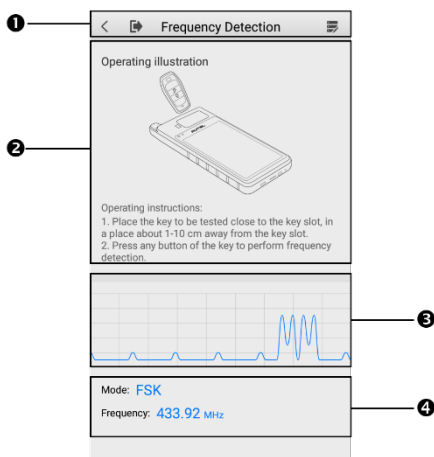

Figure 7-1 Frequency Detection Screen

1. Upper toolbar buttons. Refer to [Table 4-1 Buttons](#) to see detailed operations.
2. Operation illustration and instructions
3. Frequency waveform graph
4. Frequency mode and frequency

NOTE

If no frequency is detected for a long period, the function will exit itself.

8. IMMO

The IMMO application requires a data link to the IMMO electronic control system of the test vehicle for diagnosis via OBDII connection. The application retrieves vehicle IMMO information and performs IMMO related functions, including Key Learning, Remote Control Learning, and Remote Control Add, etc.

8.1 Getting Started

Ensure a communication link is established between the test vehicle and the tool via the MaxiVCI V200. Refer to [4.1 Confirm Vehicle Information](#) to check the operation of establishing vehicle communication.

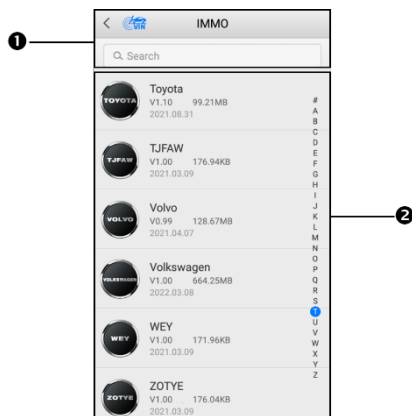

Figure 8-1 Vehicle Menu Screen

1. Top Toolbar Buttons
2. Manufacturer List

Top Toolbar Buttons

- **VIN Scan** — after the VCI is connected to the device through the vehicle's OBD Data Link Connector (DLC), turn on the ignition. The vehicle's VIN number will automatically be recognized. Tap this button can also access the Manual VIN Input function.

- **Search Bar** — displays a virtual keyboard to manually enter the specific vehicle make required.

Manufacturer List

The Manufacturer List displays various vehicle brands. To start a diagnostics session, select the proper manufacturer after the VCI device is properly connected to the test vehicle.

8.2 Vehicle Identification

The MaxiIM diagnostics system supports four methods for vehicle identification.

- AutoVIN
- Manual VIN Input
- Automatic Selection
- Manual Selection

8.2.1 AutoVIN

The MaxiIM diagnostics system features the latest VIN-based AutoVIN function to identify vehicles in just one touch, which allows the technician to quickly detect vehicles, scan all the diagnosable IMMO ECUs on every vehicle and run diagnostics on the selected system.

➤ To perform Auto VIN Scan

1. Tap the **IMMO** application from the MaxiIM Job Menu. The Manufacturer List appears.
2. Tap the **VIN Scan** button on the top toolbar to open a dropdown list.
3. Tap **AutoVIN**. Once the test vehicle is identified, the vehicle profile will appear on the screen. Confirm the vehicle profile. The tool establishes communication with the vehicle and reads the IMMO control unit information.

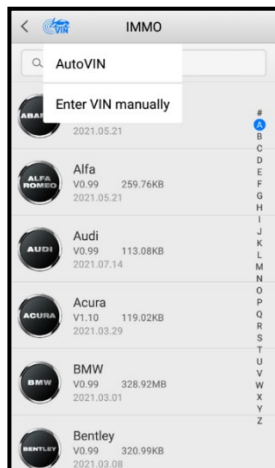

Figure 8-2 AutoVIN Screen

8.2.2 Manual VIN Input

For vehicles that do not support the AutoVIN function, you can manually enter the vehicle VIN.

- **To perform Manual VIN Input**
 1. Tap the **IMMO** application from the MaxiIM Job Menu. The Manufacturer List will appear.
 2. Tap the **VIN Scan** button on the top toolbar.
 3. Select **Enter VIN Manually**.
 4. Tap the input box and enter the correct VIN.
 5. Tap **Done** to complete or tap **Cancel** to exit the manual input.

8.2.3 Automatic Selection

The AutoVIN can be selected after selecting a test vehicle manufacturer.

- **To perform Automatic Selection**
 1. Tap the **IMMO** application button from the MaxiIM Job Menu. The Manufacturer List will appear.

2. Tap the manufacturer button of the test vehicle.
3. Select **Automatic Selection** and the VIN information will be automatically acquired. Follow the on-screen instructions to display the function screen.

8.2.4 Manual Selection

When the vehicle's VIN is not automatically retrievable through the vehicle's ECU, or specific VIN is unknown, you can manually select the vehicle.

This mode of vehicle selection is menu driven; you can simply follow the on-screen prompts and make a series of choices. Each selection you make advances you to the next screen. An **Esc** button at the bottom of the screen will bring you back to the previous step. Exact procedures may vary somewhat by various vehicles being serviced.

8.3 IMMO Screen Layout

The IMMO screens typically include three sections.

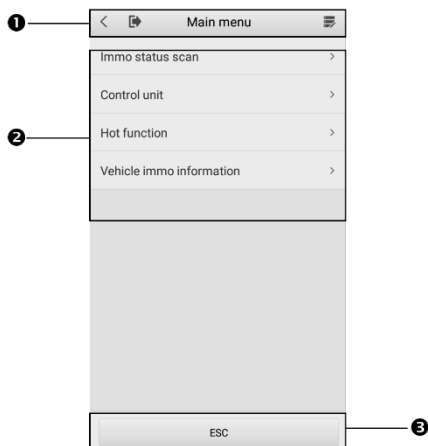

Figure 8-3 IMMO Screen Layout

1. Upper Toolbar Buttons. Refer to [Table 4-1 Buttons](#) for detailed descriptions.
2. Main Section
3. Function Buttons

Main Section

The Main Section of the screen varies depending on the stage of operations. The Main Section can show vehicle identification selections, the main menu, test data, messages, instructions, and other information.

Function Button

The displayed Function Buttons on the screen varies depending on the stage of operations. They can be used to navigate, save or clear data, to exit scanning as well as make other function controls. The functions of these buttons will be introduced respectively in the following sections of the corresponding test operations.

8.4 Screen Messages

Screen messages appear when additional input is needed before proceeding. There are mainly three types of on-screen messages as to their purposes: Confirmation, Warning, and Error.

8.4.1 Confirmation Messages

This type of messages usually displays as an “Information” screen, which informs you when you are about to perform an action that cannot be reversed or when an action has been initiated and your confirmation is needed to continue.

When a user-response is not required to continue, the message displays briefly before automatically disappearing.

8.4.2 Warning Messages

This type of messages informs you when completing the selected action may result in an irreversible change or loss of data. A typical example for this is the “Erase Codes” message

8.4.3 Error Messages

Error messages inform you when a system or procedural error has occurred. Examples of possible errors include a disconnection or communication interruption due to certain reasons.

8.5 Making Selections

The IMMO application is a menu-driven program that presents a series of choices. As a selection is made, the next menu in the series displays. Each selection narrows the focus and leads to the desired test. Tap the screen to make menu selections.

8.6 IMMO

There are mainly four options available when accessing the IMMO section:

- IMMO Status Scan
- Control Unit
- Hot Function
- Vehicle IMMO Information

8.6.1 IMMO Status Scan

The IMMO Status Scan function performs a comprehensive scanning over all the systems on the vehicle's IMMO ECU in order to locate fault systems and retrieve DTCs. The sample operation interface of IMMO Status Scan displays as below.

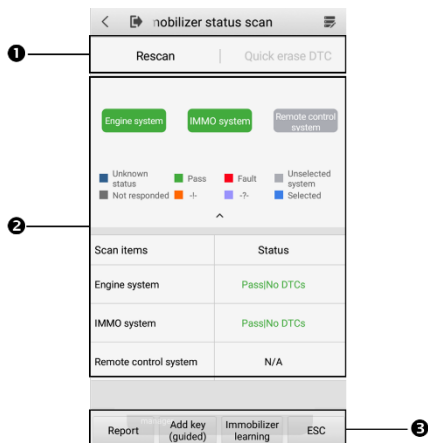

Figure 8-4 IMMO Status Scan

1. Navigation Bar
2. Main Section
3. Function Buttons

Navigation Bar

Two options are available in the Navigation Bar:

- Rescan — tap to rescan the IMMO system for DTCs.
- Quick Erase DTC — tap to erase the fault codes.

Main Section

Upper Column — displays the scanned systems highlighted by different colors. Each color represents varied status, which you can check on the screen.

Lower Column — displays detailed scan results. The left column shows scan items, and the right displays the diagnostic marks indicating different conditions of the test result.

- -!-: indicates that the scanned system may not support the code reading function, or there is a communication error between the tool and the control system.

- **-?-**: indicates that the vehicle control system has been detected, but the tool cannot accurately locate it.
- **Fault | #**: indicates there is/are detected fault code(s) present; “#” indicates the number of the detected faults.
- **Pass | No DTCs**: indicates the system has passed the scanning process and no fault has been detected.
- **Unknown Status**: Indicates the system has not been scanned.
- **Not Responded**: Indicates the system has not received a response.
- **N/A**: The system is not selected.
- **Unselected System**: The system is not selected for testing.
- **Selected**: The system is selected for testing.

Function Buttons

Button	Description
Report	Displays the diagnostic data in the report form.
Add Key (guided)	Enters the guided function of Add Key.
Immobilizer Learning	Initiates the Immobilizer Learning function.
ESC	Returns to the previous screen or exit IMMO Status Scan.

8.6.2 Control Unit

This option allows you to manually locate a required IMMO control system for testing through a series of choices. You simply follow the menu-driven procedure and make proper selection each time; the program will guide you to the IMMO function menu after a few choices you have made.

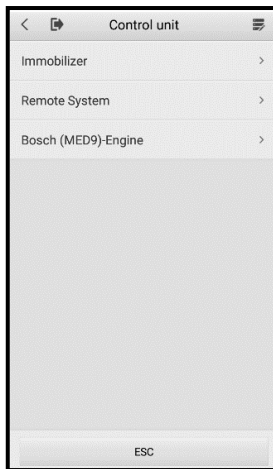

Figure 8-5 Control Unit Screen

The control unit menu options vary for different vehicles. The function menu may include:

- Immobilizer
- Remote System
- Bosch(MED9)-Engine

The functions vary by IMMO parts. Follow the on-screen instructions to select the correct IMMO part.

Take **Key Learning** as an example.

1. Choose **Immobilizer** from the Control Unit screen and select an IMMO system to enter the Instrument Cluster screen. Then tap **Key Learning**. The tool will automatically start to read IMMO data. A question mark button will be available throughout the whole process. Tap it to view help information.

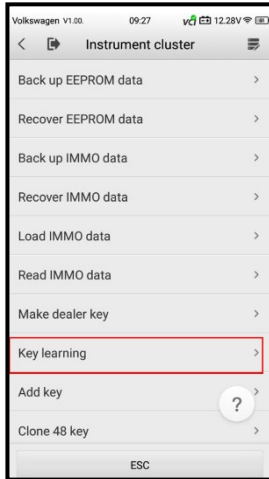

Figure 8-6 Instrument cluster Screen

2. Input the numbers of the keys to be learned and press **OK** to continue.



Figure 8-7 Key Learning Screen 1

3. Follow the on-screen instructions to place the key to be learned in the inductive area. Once done, tap **OK** to continue.

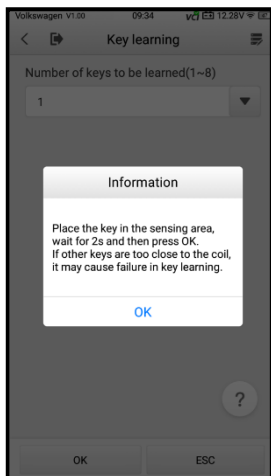

Figure 8-8 Key Learning Screen 2

4. When key learning is completed, the following screen will appear. Tap **OK** to exit the function.

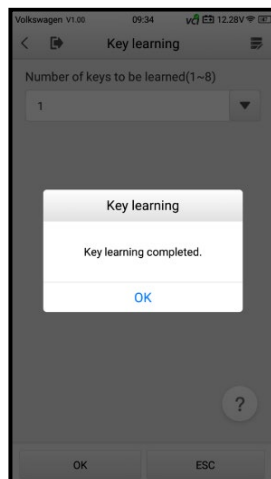

Figure 8-9 Key Learning Screen 3

8.6.3 Hot Function

Hot function consists of guided functions with step-by-step instructions. The available functions may vary depending on the test vehicle.

In this case, only Add Key (guided) function is available. Follow the on-screen instructions to complete the operation.



Figure 8-10 Hot Function Screen

8.6.4 Vehicle IMMO Information

This function retrieves and displays the specific information for the tested IMMO ECU, including vehicle VIN number, PIN code and other IMMO information.



Figure 8-11 Vehicle IMMO Information Screen

9. Special Functions

As a comprehensive key tool, the KM100E provides you with several practical special functions which consist of IMMO data processing, key unlocking, Toyota smart unlocking, universal key information detection, button adjustment, and ignition coil detection. Each special function will be introduced in the following sections.

9.1 IMMO Data Processing

By using the IMMO Data Processing function, you are allowed to load the IMMO-related ECU information of a vehicle to calculate a password and other IMMO information, which will be written into the transponder of the vehicle. This processed transponder can be used to start the vehicle, in other words, you now have an extra key available.

The IMMO data processing is menu-driven; select the correct parameter to advance the operation.

➤ **To process the IMMO data**

1. Choose a region. Currently, the KM100E can access the IMMO data of the automakers from Asia, Europe, and the USA.
2. Choose a vehicle make or search for a vehicle make in the search bar. You can use the alphabetical list on the right of the screen to fast locate a vehicle make.



Figure 9-1 Vehicle Make Selection Screen

- 1) Upper Toolbar Buttons. See [Table 4-1 Buttons](#) for detailed descriptions.
 - 2) Search Box
 - 3) Vehicle List
 - 4) Alphabetical List
3. Select an immobilization system or search for an immobilization system in the search bar. You can use the alphabetical list on the right of the screen to fast locate a system.

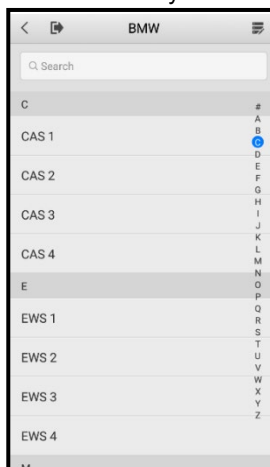

Figure 9-2 Immobilization System Selection Screen

- When the procedures above are completed, the Help Information screen will appear, on which you will be able to browse certain IMMO data that should be loaded. Tap the **Load** button at the bottom of the screen to download the data.

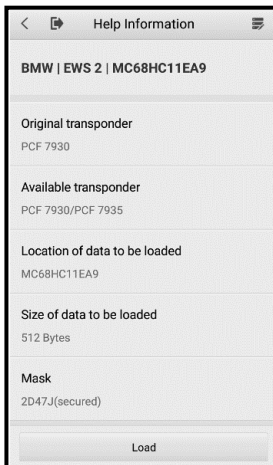

Figure 9-3 Help Information Screen

- Choose a file to store the downloaded data.

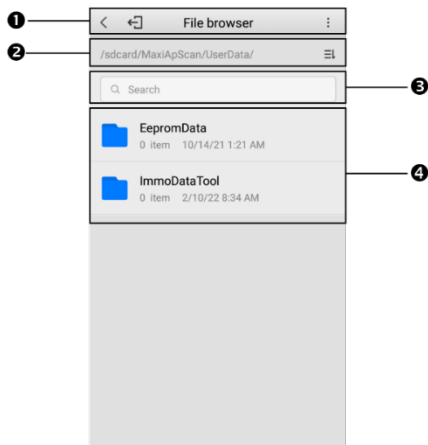





Figure 9-4 IMMO Data File Browser Screen

- Upper Toolbar Buttons

Button	Description
	Tap to return to the previous screen.
	Tap to exit the IMMO Data Processing function.
	Tap to be redirected to the document viewer.

- 2) File Route & the **Sequence** Button (). You can use the **Sequence** button to sort the files.
- 3) Search Bar
- 4) Files

9.2 Key Unlocking

The Key Unlocking function enables you to renew a used smart key to unlock a new car. This is achieved by renewing the firmware of the used smart key via cable connection.

➤ **To perform the key unlocking**

1. Choose a vehicle make or search for a vehicle make in the search box. You can use the alphabetical list on the right of the screen to fast locate a vehicle make.

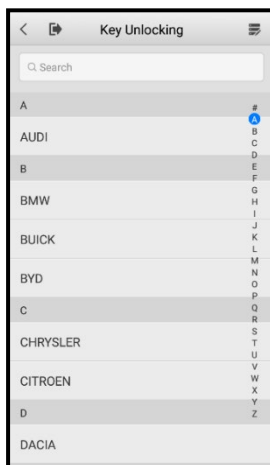

Figure 9-5 Key Unlocking Screen

2. Select the correct key information.



Figure 9-6 Key Information Selection Screen

3. The instructions and illustrations for unlocking keys will appear. Follow the on-screen instructions to complete the operation:
 - 1) Remove the battery from your smart key.
 - 2) Connect the cables per the diagram.
 - 3) Tap the **Unlock** button at the bottom of the screen. The unlocking of the key will be completed automatically.

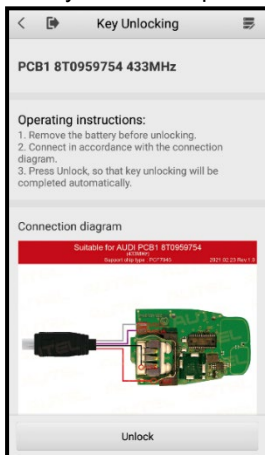

Figure 9-7 Key Unlocking Operation Screen

9.3 Toyota Smart Unlocking

You may use this function to unlock other Toyota models with your Toyota smart key.

- **To unlock the Toyota smart keys**
 1. Place your key into the key slot.
 2. Tap the **Unlock** button at the bottom screen to start unlocking.
 3. The LED on your key will illuminate, indicating that the procedure was successful.

NOTE

1. Make sure the key battery is properly installed before unlocking keys.
 2. Unlocking of 4D 40/80-bit and 8A 128-bit original Toyota smart chips is supported.
-

9.4 Universal Key Information Detection

The Universal Key Information Detection function is designed to read the Autel universal key information, including the serial number, key ID, and IMMO version, etc.

- **To detect the universal key information**
 1. Place the smart key into the key slot and keep it stable.
 2. Tap the **Detect** button at the bottom of the screen to start detecting the universal key information. Relevant key information will appear.

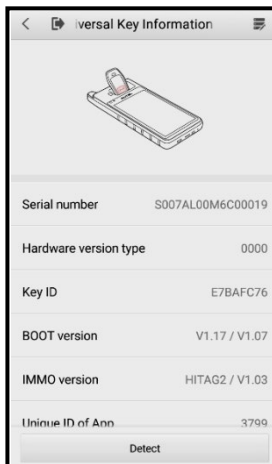

Figure 9-8 Universal Key Information Screen

9.5 Button Customization

By using the Button Customization function, you are able to assign the button functions on the Autel universal key.

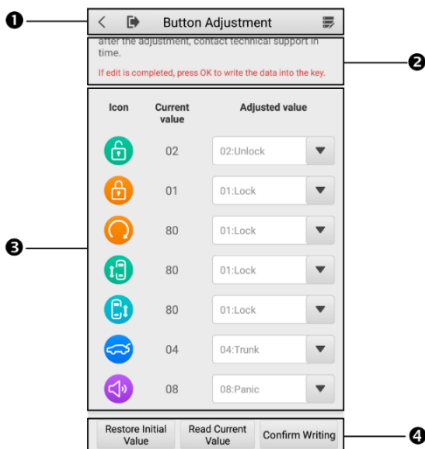

Figure 9-9 Button Customization Screen

1. Upper Toolbar Buttons. Refer to [Table 4-1 Buttons](#) for more details.
2. Note Information — displays important information
3. Main operation screen
 - Left column — displays the key button icon
 - Middle column — displays the current button value
 - Right column — tap to adjust the button value
4. Function buttons

Button	Description
Restore Initial Value	Tap to return to the default settings.
Read Current Value	Tap to read and display the current values.
Confirm Writing	Tap to write the data into the key.

 **NOTE**

1. The icons of the remote control buttons on the left are consistent with the key buttons, but do not necessarily represent the actual button functions.
 2. When the function of a button on the universal key is inconsistent with that of the original key or there is a customized requirement, modify the corresponding button value.
 3. When the number of buttons on the universal key is not enough, multi-button combinations can be added for corresponding button functions.
 4. If there are any function-related problems after customization, contact Autel technical support to resolve the matter.
-

9.6 Ignition Coil Detection

The Ignition Coil Detection function enables the key tool to gather the data pertaining to the IMMO protocol and transponder type of the vehicle.

➤ **To detect the ignition coil**

1. Place the low frequency detection collector close (no more than 4 inches/10 cm) to the ignition coil or the emergency start coil. If the signal is not detected, try turning on the ignition repeatedly and adjust the position of the low frequency detection collector.
2. If a signal is detected, the current detection result and the transponder type will appear on the screen. Detection records will appear at the bottom of the screen.

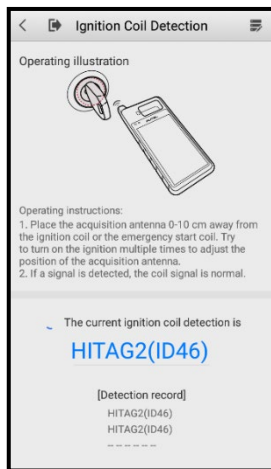

Figure 9-10 Ignition Coil Detection Screen

10. Settings

Settings allows you to adjust default settings and view information about the key tool system.

- Market
- Feedback
- VCI Manager
- System Settings
- Unit
- About

10.1 Market

This option allows you to select the region of work: Europe or North America.

10.2 Feedback

This option allows you to report any problems that you encounter while using the tool. Enter your phone number or email address and a subject and describe your problem. You can attach a photo from your album, take a photo or record a video to add to your report.

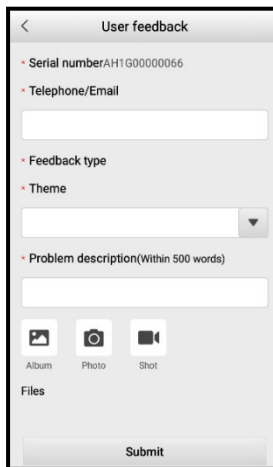

Figure 10-1 User Feedback Screen

10.3 VCI Manager

This application pairs the tool with the MaxiVCI V200, checks the communication status, and updates the VCI firmware.

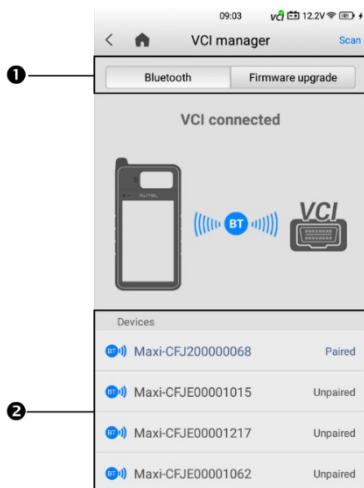

Figure 10-2 VCI Manager Screen

1. Connection Mode

There are two connection modes available for selection. The connection state displays.

- **Bluetooth** — when paired to a wireless device, the connection state reads, “Paired.” Otherwise, it reads, “Unpaired.”
- **Firmware Upgrade** — updates the V200 with the latest version of firmware via the Internet.

2. Bluetooth Listing

The list section displays the serial numbers for all the V200 devices available for pairing. Tap a VCI device to start pairing. The Bluetooth status icon in the center of the screen indicates the Bluetooth signal strength.

10.3.1 Bluetooth Connection

The MaxiVCI V200 needs to be connected to the vehicle, so that it is powered during the synchronization procedure. Turn the vehicle’s ignition to the ON position. Ensure the tool has sufficient battery life or is connected to an external power supply.

➤ **To pair the MaxiVCI V200 with the tool**

1. Power on the tool.
2. Insert the 16-pin vehicle data connector of the MaxiVCI V200 into the vehicle’s DLC.
3. Tap the **Settings** application on the MaxiIM Job Menu on the tool, and select **VCI Manager**.
4. Tap **Scan** on the upper-right corner of the screen. The device will automatically search for available V200 units.
5. The device name may display as “Maxi”, suffixed with a serial number. Select the appropriate device for pairing.
6. When paired successfully, the connection status will read, **“Paired.”**
7. Once paired, the VCI button on the upper-right corner of the screen will display a green check mark and the Connection LED on the MaxiVCI V200 will light solid blue. This signifies

that the tool is connected to the MaxiVCI V200 and is ready to perform vehicle diagnosis.

8. Tap the paired device again to disconnect it.
9. Tap the **Home** icon on the top-left to return to the MaxiIM Job Menu.

NOTE

A MaxiVCI V200 can be paired to only one tool at a time, and once it is paired, the device will not be discoverable to other devices.

10.3.2 Firmware Upgrade

Before upgrading the V200 firmware, ensure your Internet connection is stable. The V200 supports both Bluetooth and USB communications.

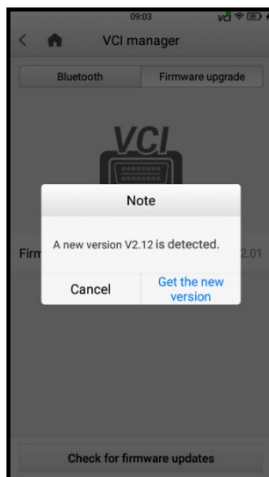

Figure 10-3 Firmware Upgrade Screen

Upgrade via Bluetooth

- **To upgrade the MaxiVCI V200 firmware via Bluetooth**
 1. Connect the V200 to the vehicle or charge it with an adapter before pairing it with the tool via Bluetooth.
 2. On the MaxiIM Job Menu, tap **Settings** > **VCI Manager**, and

select the **Bluetooth** from the connection mode list. Pair the tool with the V200 by tapping the device serial number on the screen.

3. When pairing is successful, the connection status will read, **"Paired."**
4. The current version of the VCI firmware will be displayed. Tap **Check for firmware updates** to check if an update is available. If an update is available, tap **Get the new version** to upgrade the firmware or tap **Cancel** to exit the upgrade.

Upgrade via USB

➤ To upgrade the MaxiVCI V200 firmware via USB

1. Connect the V200 to the key tool using a USB-C cable.
2. On the MaxiIM Job Menu, tap **Settings > VCI Manager** and select the **Firmware Upgrade** from the connection mode list.
3. The current version of the VCI firmware will be displayed. Tap **Check for firmware updates** to check if an update is available. If an update is available, tap **Get the new version** to upgrade the firmware or tap **Cancel** to exit the upgrade.

10.4 System Settings

This function provides you with direct access to the System Settings screen, where you can adjust various system settings for the tool, including wireless and network settings, and various device settings such as sound, display, and language settings.

10.5 Units

This option allows you to set the units of measurement system for the diagnostic system.

➤ To set the units of measurement system

1. Tap the **Settings** application on the MaxiIM Job Menu.
2. Tap **Units**.

3. Select the desired units of measurement system (Metric or Imperial). A check mark will display to the right of your active selection.
4. Tap the **Home** button on the top-left corner to return to the MaxiIM Job Menu.

10.6 About

The About screen displays information pertaining to the KM100E tool, including the password, system version, hardware version, and serial number.

11. Updates

The Updates screen allows you to download the latest software. These updates can improve the MaxiIM KM100E, typically by adding new tests, new models, or enhanced applications to the database.

The tool automatically searches for available updates for all of the MaxiIM software when it is connected to the Internet. Any updates that are found can be downloaded and installed on the device. This section describes installing an update to the MaxiIM System.

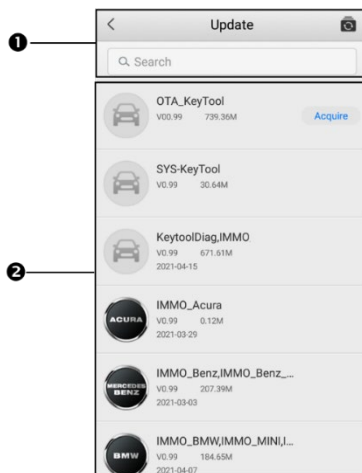

Figure 11-1 Updates Screen



1. Navigation and Controls

- Back Button — returns to the MaxiIM Job Menu.
- Update All — downloads all available updates.
- Search Bar — searches for specific update items by name or keyword.

2. Main Section

- Left Column — displays manufacturer buttons. Tap the vehicle brand of your selection to open an information screen to view more details.
- Middle Column — displays available software updates and a brief introduction about the new changes to the software operation or capabilities.
- Right Column — displays an update button, which also works as an update progress bar indicating the completion status in percentage when downloading the software selected.

➤ To update the software

1. Make sure the tool is connected to a power source with stable access to the Internet.
2. Tap **Update** on the MaxiIM Job Menu, or tap the update notification message when received one. The Update application screen displays.
3. Check all available updates:
 - If you decide to update all the items of the software, tap the  button on the upper-right corner to have all the downloadable items in updating status. This will also update all the items at once if not tap the  button again to suspend or resume the updating process.
 - If you only want to update one or some of the item(s), tap the **Acquire** button on the right column of the specific item(s). Tap the button again to suspend or resume the updating process.
4. When the updating process is completed, the software will be installed automatically. The previous version will be replaced.

12. Data Manager

The Data Manager application allows you to store, print, and review the saved files, manage the workshop information, customer information records and keep test vehicle history records.

Selecting the Data Manager application opens the file system menu. There are six main functions available.

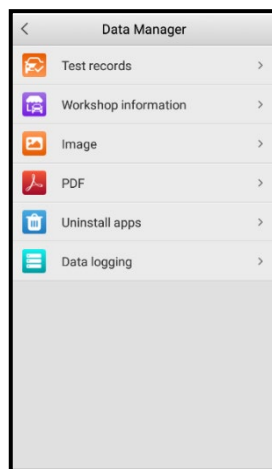

12-1 Data Manager Screen

12.1 Test Records

This function stores test vehicle history records, in terms of universal key, transponder function, and IMMO-related information from previous tests. All information is displayed in summarized details. Tap on a function icon to resume the previous operation.

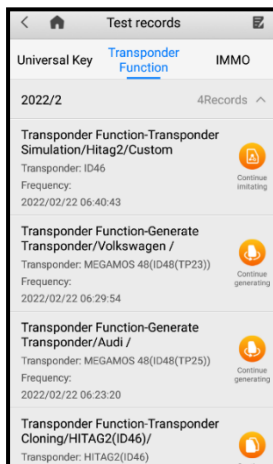

12-2 Test Records Screen

12.2 Workshop Information

The Workshop Information screen allows you to enter, edit, and save detailed workshop information, such as shop name, address, phone number, and other remarks, which, when printing vehicle diagnostic reports and other associated test file, will display as the header of the printed documents.

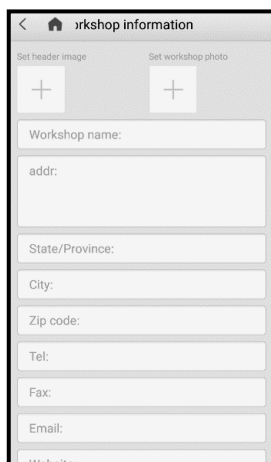

12-3 Workshop Information Screen

- **To edit the Workshop Information sheet**
 1. Tap the **Data Manager** application on the MaxiIM Job Menu.
 2. Select **Workshop Information**.
 3. Tap on each field to input information.
 4. Tap **Done** to save the updated workshop information record, or tap **Cancel** to exit without saving.

12.3 Image

The Image section is a database containing all your captured screenshots.

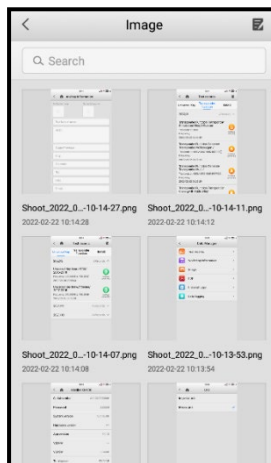

12-4 Image Screen

- **To edit/delete image(s)**
 1. Select **Data Manager** from the MaxiIM Job Menu.
 2. Select **Image** to access the image database.
 3. Tap **Edit** on the top-right corner of the screen. The editing screen will appear.
 4. Select the images you want to edit.
 5. Tap **Delete** to delete the selected images or delete all images. Tap **Print** to print the selected images or send the selected images to an email.

12.4 PDF

The PDF section stores and displays all your PDF (portable document format) files. After entering the PDF database, select a PDF file to view the stored information.

This section uses the standard Adobe Reader application for file viewing and editing. Refer to the associated Adobe Reader manual for more detailed instructions.

12.5 Uninstall Apps

This section allows you to manage the firmware applications installed on the MaxiM System. Selecting this section opens a managing screen, on which you can check all the available vehicle diagnostic applications.

Select the vehicle firmware you want to delete by tapping on the car brand icon, the selected item will display a blue check mark on the upper-right corner. Tap the **Delete** button on the top bar to delete the firmware from the system database.

12.6 Data Logging

The Data Logging screen keeps records of all **Feedback** (submitted), **No feedback** (saved) and **History** (up to the latest 20 test records) data on the diagnostic system. Autel support personnel will receive and process the submitted reports through the Support platform, and will send back problem solutions to the corresponding Data Logging session, on which you are also allowed to have a direct conversation with the support personnel.

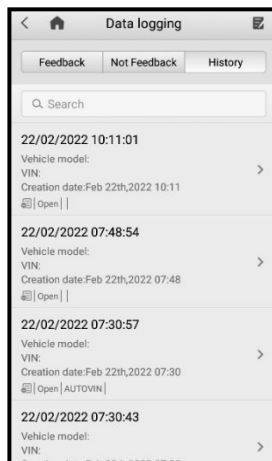

12-5 Data Logging Screen

➤ To make a reply in a Data Logging session

1. Tap **Feedback** to view a list of submitted data logs.
2. Select a specific item to view the latest update of the processing progress.
3. Tap the text field at the bottom of the screen and enter text. Additionally, you can add the attachment if needed.
4. Tap **Send** to deliver your message to the technical center.

13. Remote Desktop

The Remote Desk application launches the TeamViewer QuickSupport program, which is a simple, fast and secure remote control screen. You can use the application to receive ad-hoc remote support from Autel's support center, colleagues, or friends, by allowing them to control your MaxiIM tool on their PC via the TeamViewer software.

If you think of a TeamViewer connection as a phone call, the TeamViewer ID would be the phone number under which all TeamViewer Clients can be reached separately. Computers and mobile devices that run TeamViewer are identified by a globally unique ID. The first time the Remote Desktop application is launched, this ID is generated automatically based on the hardware characteristics and will not change later on.

Make sure the tool is connected to the Internet before launching the Remote Desktop application, so that the tool is accessible to receive remote support from a third party.

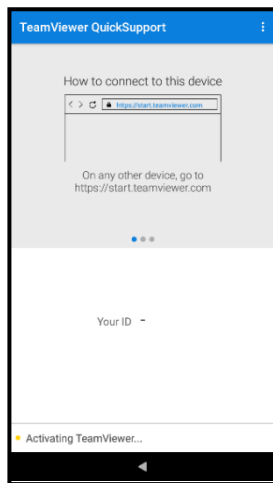

13-1 Remote Desktop Screen

➤ **To receive remote support from a partner**

1. Power on the tool.
2. Tap the **Remote Desktop** application on the MaxilM Job Menu. The TeamViewer QuickSupport screen displays and the device ID is generated and shown.
3. The technician must install the Remote Control software to their PC by downloading the TeamViewer full version program online (see <http://www.teamviewer.com>), and then launch the software.
4. Provide your ID to the technician, and wait for them to send you a remote control request.
5. A pop-up dialog box displays to ask for your confirmation to allow remote control on your device.
6. Tap **Allow** to accept, or tap **Deny** to reject.

Refer to the associated TeamViewer documents for additional information.

14. Tool Registration

To update the software on your tool, the tool must be registered. The installation of the latest firmware and vehicle software is vital to the successful operation of the KM100E. Register the tool prior to using. Register directly on the tool or via Internet on a mobile device or computer.

➤ **To register the tool**

1. Visit the website <http://pro.autel.com>.
2. If you have an Autel account, sign in with your account ID and password.
3. If you are a new member to Autel, click the **Register** button to create your Autel ID.
4. Enter the required personal information in the input fields.
5. Enter your email address, then click **Request**. You will receive an email from Autel with your verification code. Open the email and copy the code into the proper input box.
6. Set a password for your account, and enter the password again to confirm. Read the **Autel User Service Agreement** and **Autel Privacy Policy**, then check the box to accept the terms. After all the information is entered, click **Register**. A Product Registration screen will appear.
7. Your product serial number and password are required to complete your registration. To find your serial number and password on the tool: go to **Settings > About**.
8. Enter your tool's serial number and password on the Product Registration screen. Enter the CAPTCHA code and click **Submit** to complete your registration procedure.

15. Academy

The Academy provides access to various onboard instructional videos and manuals produced by top-notch technicians and product experts, covering information on main functions. Please access the videos or articles saved on the tool by tapping the images with hyperlinks displayed under this application.

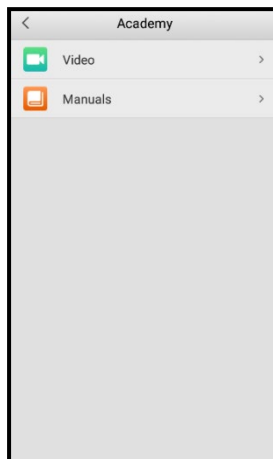

15-1 Academy Screen

16. Maintenance and Service

16.1 Maintenance Instructions

The following shows how to maintain your devices, together with precautions to take.

- Use a soft cloth and alcohol or a mild window cleaner to clean the tool's touchscreen.
- Do not use any abrasive cleansers, detergent or automotive chemicals on the tool.
- Only use the device in dry conditions within normal operating temperatures.
- Dry your hands before using the tool. The touchscreen may not work if the touchscreen is moist, or if you tap the touchscreen with wet hands.
- Do not store the devices in humid, dusty dirty areas.
- Before and after use, check the housing, wiring, and connectors for dirt and damage.
- After each use, wipe the device housing, wiring, and connectors clean with a damp cloth.
- Do not attempt to disassemble your tool or VCI unit.
- Take care not to drop the device or allow anything heavy to drop on the device.
- Use only authorized battery chargers and accessories. Any malfunction or damage caused by the use of unauthorized battery charger and accessories will void the limited product warranty.
- Ensure that the battery charger does not come in contact with conductive objects.
- Do not operate the tool next to anything such as a microwave oven, cordless phone and some medical or scientific instruments that might interfere with or prevent signal interference.

16.2 Troubleshooting Checklist

- A. When the tool does not work properly:
- Make sure the tool has been registered online.
 - Make sure the system software and diagnostic application software are properly updated.
 - Make sure the tool is connected to the Internet.
 - Check all cables, connections, and indicators to see if the signal is being received.
- B. When battery life is shorter than usual:
- This may happen when you are in an area with low signal strength.
 - Turn off your device when not in use.
- C. When unable to power on the tool:
- Make sure the tool is connected to a power source or has sufficient battery.
- D. When unable to charge the tool:
- Your charger maybe out of order. Contact the seller.
 - You may be attempting to use the device in an overly hot/cold temperature. Use the tool in an environment within normal operating temperatures.
 - Your device may have not been properly connected to the charger. Check the connector.

NOTE

If your problems persist, please contact Autel's technical support.

16.3 About Battery Usage

Your tool is powered by a built-in Lithium-ion Polymer battery. The Lithium-ion Polymer battery can recharge while some charge remains without reducing your tool's autonomy due to the "battery memory effect" inherent in this type of battery technology.



DANGER

1. The built-in Lithium-ion Polymer battery is factory replaceable only; incorrect replacement or tampering with the battery pack may cause an explosion.
 2. Do not use a damaged battery charger.
-
- Do not disassemble or open crush, bend or deform, puncture or shred.
 - Do not modify or remanufacture, attempt to insert foreign objects into the battery, expose to fire, explosion or other hazards.
 - Make sure to only use the supplied charger and USB cables. Using an unapproved charger or unapproved USB cable might not working correctly or might damage the tool or VCI.
 - Only use the supplied charging device that has been qualified for use with the device. Use of an unqualified battery or charger may present a risk of fire, explosion, leakage or other hazards.
 - Avoid dropping the tool. If the tool is dropped, especially on a hard surface, and the user suspects damage, take it to a service center for inspection.
 - Working closer to the Wi-Fi router improves the working battery life of the tool as less battery power is consumed to make connection.
 - The battery recharging time varies depending on the remaining battery capacity.
 - Battery life inevitably shortens over time.
 - Since overcharging may shorten battery life, unplug tool and charger from power outlet when tool is sufficiently charged.
 - Leaving the tool in hot or cold places, especially inside a vehicle in summer or winter, may reduce the battery's capacity and longevity. Always keep the battery within normal temperatures.

16.4 Service Procedures

This section introduces information for technical support, repair service, and application for replacement or optional parts.

16.4.1 Technical Support

If you have any question or problem on the operation of the product, please contact us (see the following contact info).

- **Phone:** +86 (0755) 8614-7779 (Monday-Friday, 9AM-6PM Beijing Time)
- **Email:** support@autel.com
- **Address:** Floor 2, Caihong Keji Building, 36 Hi-tech North Six Road, Songpingshan Community, Xili Sub-district, Nanshan District, Shenzhen City, China
- **Web:** www.autel.com

16.4.2 Repair Service

If it becomes necessary to return your device for repair, please download the repair service form from www.autel.com, and fill it in. The following information must be included:

- Contact name
- Return address
- Telephone number
- Product name
- Complete description of the problem
- Proof-of-purchase for warranty repairs
- Preferred method of payment for non-warranty repairs

NOTE

For non-warranty repairs, payment can be made with Visa, Master Card, or with approved credit terms.

Send the device to the below address:

Floor 2, Caihong Keji Building, 36 Hi-tech North Six Road, Songpingshan Community, Xili Sub-district, Nanshan District, Shenzhen City, China

16.4.3 Other Services

You can purchase the optional accessories directly from Autel's authorized tool suppliers.

Your purchase order should include the following information:

- Contact information
- Product or part name
- Item description
- Purchase quantity

17. Compliance Information

FCC Compliance

This device complies with Part 15 of the FCC rules and Industry Canada's license-exempt RSSs. Operation is subject to the following two conditions:

1. This device may not cause harmful interference.
2. This device must accept any interference received, including interference that may cause undesired operation.

Cet appareil est conforme aux CNR exempts de licence d'Industrie Canada. Son fonctionnement est soumis aux deux conditions suivantes:

1. Ce dispositif ne peut causer des interférences; et
2. Ce dispositif doit accepter toute interférence, y compris les interférences qui peuvent causer un mauvais fonctionnement de l'appareil.

WARNING

Changes or modifications not expressly approved by the party responsible for compliance could void the user's authority to operate the equipment.

NOTE

This equipment has been tested and found to comply with the limits for a Class B digital device, pursuant to Part 15 of the FCC Rules. These limits are designed to provide reasonable protection against harmful interference in a residential installation.

This equipment generates, uses and can radiate radio frequency energy and, if not installed and used in accordance with the instructions, may cause harmful interference to radio communications. However, there is no guarantee that interference will not occur in a particular installation. If this equipment does cause harmful interference to radio or television reception, which can be determined by turning the equipment off and on, the user is encouraged to try to correct the interference by one or more of the following measures:

- Reorient or relocate the receiving antenna.

- Increase the separation between the equipment and receiver.
- Connect the equipment into an outlet on a circuit different from that to which the receiver is connected.
- Consult the dealer or an experienced radio/TV technician for help.

Changes or modifications not expressly approved by the party responsible for compliance could void the user's authority to operate the equipment.

SAR

The radiated output power of this device is below the FCC radio frequency exposure limits. Nevertheless, the device should be used in such a manner that the potential for human contact is minimized during normal operation.

The exposure standard for wireless devices employs a unit of measurement known as the Specific Absorption Rate, or SAR. The SAR limit set by the FCC is 1.6 W/Kg. Tests for SAR are conducted using standard operating positions accepted by the FCC with the device transmitting at its highest certified power level in all tested frequency bands.

Although the SAR is determined at the highest certified power level, the actual SAR level of the device while operating can be well below the maximum value. This is because the device is designed to operate at multiple power levels so as to use only the power required to reach the network. To avoid the possibility of exceeding the FCC radio frequency exposure limits, human proximity to antenna should be minimized.

RF WARNING STATEMENT

The device has been evaluated to meet general RF exposure requirement. The device can be used in portable exposure condition without restriction.

The term "IC" before the radio certification number only signifies that IC technical specifications were met.

CE COMPLIANCE

This product is declared to conform to the essential requirements of the following Directives and carries the CE mark accordingly:

RED Directive 2014/53/EU

18. Warranty

18.1 Limited One-Year Warranty

Autel Intelligent Technology Corp., Ltd. (the Company) warrants to the original retail purchaser of this key tool, that should this product or any part thereof during normal consumer usage and conditions, be proven defective in material or workmanship that results in product failure within one (1) year period from the date of purchase, such defect(s) will be repaired, or replaced (with new or rebuilt parts) with Proof of Purchase, at the Company's option, without charge for parts or labor directly related to the defect(s).

NOTE

If the warranty period is inconsistent with local laws and regulations, please comply with the relevant local laws and regulations.

The Company shall not be liable for any incidental or consequential damages arising from the use, misuse, or mounting of the device. Some states do not allow limitation on how long an implied warranty lasts, so the above limitations may not apply to you.

This warranty does not apply to:

- a) Products subjected to abnormal use or conditions, accident, mishandling, neglect, unauthorized alteration, misuse, improper installation or repair or improper storage;
- b) Products whose mechanical serial number or electronic serial number has been removed, altered or defaced;
- c) Damage from exposure to excessive temperatures or extreme environmental conditions;
- d) Damage resulting from connection to, or use of any accessory or other product not approved or authorized by the Company;
- e) Defects in appearance, cosmetic, decorative or structural items such as framing and non-operative parts;
- f) Products damaged from external causes such as fire, dirt, sand, battery leakage, blown fuse, theft or improper usage of any electrical source.

! **IMPORTANT**

All contents of the product may be deleted during the process of repair. You should create a back-up copy of any contents of your product before delivering the product for warranty service.

AUTEL[®]