

Trademarks

Autel®, MaxiSys®, MaxiDAS®, MaxiScan®, MaxiRecorder®, MaxiTPMS®, AutoLink®, and MaxiCheck® are trademarks of Autel Intelligent Technology Corp., Ltd., registered in China, the United States, and other countries. All other marks are trademarks or registered trademarks of their respective holders.

Copyright Information

No part of this manual may be reproduced, stored in a retrieval system or transmitted, in any form or by any means, electronic, mechanical, photocopying, recording, or otherwise, without the prior written permission of Autel.

Disclaimer of Warranties and Limitation of Liabilities

All information, specifications and illustrations in this manual are based on the latest information available at the time of printing.

Autel reserves the right to make changes at any time without notice. While information of this manual has been carefully checked for accuracy, no guarantee is given for the completeness and accuracy of the contents, including but not limited to the product specifications, functions, and illustrations.

Autel will not be liable for any direct, special, incidental, indirect damages, or for any economic consequential damages (including lost profits) as a result of using this product.

! IMPORTANT

Before operating or maintaining this unit, please read this manual carefully, paying extra attention to the safety warnings and precautions.

For Services and Support:



pro.autel.com

www.autel.com



1-855-288-3587 (North America)

+86 (0755) 8614-7779 (China)



support@autel.com

For technical assistance in all other markets, please refer to *Service and Support* in this manual.

Safety Precautions and Warnings

To prevent personal injury or damage to vehicles and/or the scan tool, read this manual first and observe the following safety precautions at a minimum whenever working on a vehicle:

- Always perform automotive testing in a safe environment.
- Wear safety eye protection that meets ANSI standards.
- Keep clothing, hair, hands, tools, and test equipment, etc., away from all moving or hot engine parts.
- Operate the vehicle in a well-ventilated work area.
- Put blocks in front of the drive wheels and never leave the vehicle unattended while running tests.
- Use extreme caution when working around the ignition coil, distributor cap, ignition wires and spark plugs. These components create hazardous voltages when the engine is running.
- Put the transmission in PARK (for automatic transmission) or NEUTRAL (for manual transmission) and make sure the parking brake is engaged.
- Keep a fire extinguisher suitable for gasoline/chemical/electrical fires nearby.
- Do not connect or disconnect any test equipment while the ignition is on or the engine is running.
- Keep the scan tool dry, clean, and free from oil, water, and grease. Use a mild detergent on a clean cloth to clean the outside of the scan tool, when necessary.

CONTENTS

	SAFETY PRECAUTIONS AND WARNINGS.....	ii
1	USING THIS MANUAL	1
	CONVENTIONS.....	1
2	GENERAL INFORMATION.....	3
	ON-BOARD DIAGNOSTICS (OBD/OBDII)	3
	DIAGNOSTIC TROUBLE CODES (DTCs)	3
	LOCATION OF THE DATA LINK CONNECTOR (DLC)	4
	OBDII READINESS MONITORS	5
	OBDII MONITOR READINESS STATUS.....	6
	OBDII DEFINITIONS	7
	OBDII MODES OF OPERATION	8
3	USING THE SCAN TOOL.....	11
	TOOL DESCRIPTION	11
	SPECIFICATIONS	13
	ACCESSORIES INCLUDED	13
	NAVIGATION CHARACTERS	13
	KEYBOARD.....	14
	POWER.....	14
	VEHICLE COVERAGE	14
	PRODUCT TROUBLESHOOTING	15
4	OBDII DIAGNOSTICS	17
	READ CODES	18
	ERASE CODES	21
	LIVE DATA	23
	VIEW FREEZE FRAME	31
	I/M READINESS	32
	ON-BOARD MONITOR TEST	37
	COMPONENT TEST.....	40
	VEHICLE INFORMATION.....	41
	MODULES PRESENT	42

5	ABS DIAGNOSIS.....	44
	VEHICLE SELECTION	45
	READING ABS CODES	46
	ERASING ABS CODE	47
6	BATTERY TEST	49
	STARTING SYSTEM TEST	49
	CHARGING SYSTEM TEST	53
7	DTC LOOKUP	57
8	PLAYBACK.....	59
	REVIEW DATA	59
	PRINT DATA	61
9	SETUP.....	62
	LANGUAGE.....	63
	CONFIGURE MONITORS	63
	UNIT OF MEASURE	65
	KEY BEEP SETTINGS.....	66
	STATUS BEEP SETTINGS	67
	TOOL SELF-TEST	67
	SET DATA LOG	69
	UPLOAD DATA LOG MODE	70
	ABOUT.....	71
10	UPDATES.....	73
	REGISTER THE TOOL.....	73
	UPDATE PROCEDURE.....	74
11	COMPLIANCE INFORMATION	76
12	WARRANTY AND SERVICE	78
	LIMITED ONE YEAR WARRANTY.....	78
	SERVICE AND SUPPORT.....	79

1 Using This Manual

This manual contains device usage instructions.

Some illustrations shown in this manual may contain modules and optional equipment that are not included in your system. Contact your sales representative for availability of other modules and optional tools or accessories.

Conventions

The following conventions are used:

Bold Text

Bold text is used to highlight selectable items such as buttons and menu options.

Example:

- Tap **OK**.

Notes and Important Messages

Notes

A **NOTE** provides helpful information such as additional explanations, tips, and comments.

Important

IMPORTANT indicates a situation which, if not avoided, may result in damage to the test equipment or vehicle.

Hyperlinks

Hyperlinks or links that take you to other related articles, procedures, and illustrations are active in electronic documents. Blue italic text indicates a selectable hyperlink and blue underlined text indicates a website link or an email address link.

Illustrations

Illustrations used in this manual are samples, and the actual testing screen may vary for each vehicle being tested. Observe the menu titles and on-screen instructions to make correct option selection.

2 General Information

On-Board Diagnostics (OBD/OBDII)

The first generation of On-Board Diagnostics (called OBDI) was developed by the California Air Resources Board (ARB) and implemented in 1988 to monitor some of the emission control components on vehicles. As technology evolved and the desire to improve the On-Board Diagnostic system increased, a new generation of On-Board Diagnostic system was developed. This second generation of On-Board Diagnostic regulations is called “OBDII.”

The OBDII system is designed to monitor emission control systems and key engine components by performing either continuous or periodic tests of specific components and vehicle conditions. When a problem is detected, the OBDII system turns on a warning light on the vehicle instrument panel to alert the driver typically by the phrase of “Check Engine” or “Service Engine Soon.” The system will also store important information about the detected malfunction so that a technician can accurately find and fix the problem. Here below follow three pieces of such valuable information:

- 1) Whether the Malfunction Indicator Light (MIL) is commanded “on” or “off.”
- 2) Which, if any, Diagnostic Trouble Codes (DTCs) are stored.
- 3) Readiness Monitor status.

Diagnostic Trouble Codes (DTCs)

OBDII Diagnostic Trouble Codes are codes that are stored by the on-board computer diagnostic system in response to a problem found in the vehicle. These codes identify a particular problem and are intended to provide you with a guide as to where a fault might be occurring within a vehicle. OBDII Diagnostic Trouble Codes consist of a five-digit alphanumeric code. The first letter identifies which control system sets the code. The four numbers provide additional information on where the DTC originated and the operating conditions that caused it to set. Here below is an example to illustrate the structure of the digits:

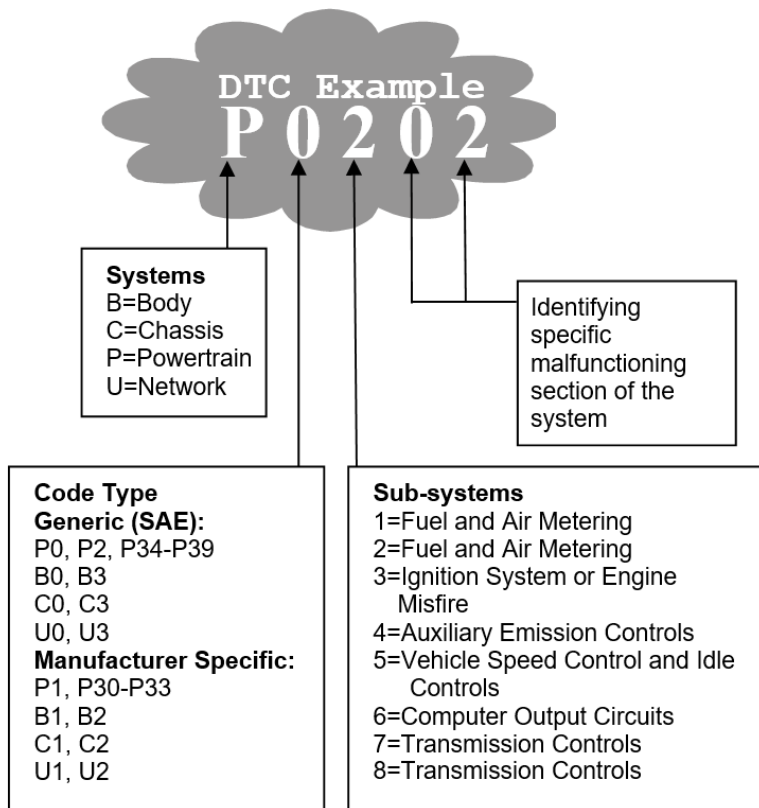

Location of the Data Link Connector (DLC)

The DLC (Data Link Connector or Diagnostic Link Connector) is a standardized 16-cavity connector where diagnostic scan tools interface with the vehicle's on-board computer. The DLC is usually located 12 inches from the center of the instrument panel (dashboard), under or around the driver's side for most vehicles. If the DLC is not located under the dashboard, a label should be there telling the location. For some Asian and European vehicles, the DLC is located behind the ashtray and the ashtray must be removed to access the connector. If the DLC cannot be found, refer to the vehicle's service manual for the location.

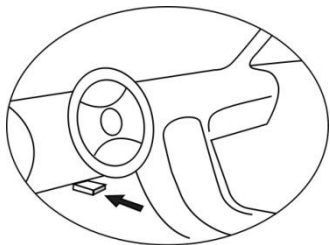

OBDDII Readiness Monitors

An important part of a vehicle's OBDDII system is the Readiness Monitors, which are indicators used to find out if all of the emissions components have been evaluated by the OBDDII system. They run periodic tests on specific systems and components to ensure that they are performing within the allowable limits.

Currently, there are eleven OBDDII Readiness Monitors (or I/M Monitors) defined by the U.S. Environmental Protection Agency (EPA). Not all monitors are supported by all vehicles and the exact number of monitors in any vehicle depends on the motor vehicle manufacturer's emissions control strategy.

Continuous Monitors — Some of the vehicle components or systems are continuously tested by the vehicle's OBDDII system, while others are tested only under specific vehicle operating conditions. The continuously monitored components listed below are always ready:

1. Misfire
2. Fuel System
3. Comprehensive Components (CCM)

Once the vehicle is running, the OBDDII system is continuously checking the above components, monitoring key engine sensors, watching for engine misfire, and monitoring fuel demands.

Non-Continuous Monitors — Unlike the continuous monitors, many emissions and engine system components require the vehicle to be operated under specific conditions before the monitor is ready. These monitors are termed non-continuous monitors. For different ignition engine types, the available monitors are different too.

The following monitors are to be used for spark ignition engines only:

- EGR System
- O₂ Sensors
- Catalyst
- Evaporative System
- O₂ Sensor Heater
- Secondary Air
- Heated Catalyst

The following monitors are to be used for compression ignition engines only:

- EGR System
- NMHC Catalyst
- NO_x Aftertreatment
- Boost Pressure System
- Exhaust Gas Sensor
- PM Filter

OBDDII Monitor Readiness Status

OBDDII systems must indicate whether or not the vehicle PCM's monitor system has completed testing on each component. Components that have been tested will be reported as "Ready," or "Complete," meaning they have been tested by the OBDDII system. The purpose of recording readiness status is to allow inspectors to determine if the vehicle's OBDDII system has tested all the components and/or systems.

The power-train control module (PCM) sets a monitor to "Ready" or "Complete" after an appropriate drive cycle has been performed. The drive cycle that enables a monitor and sets readiness codes to "Ready" varies for each individual monitor. Once a monitor is set as "Ready" or "Complete," it will remain in this state. A number of factors, including erasing of diagnostic trouble codes (DTCs) with a scan tool or a disconnected battery, can result

in Readiness Monitors being set to “Not Ready.” Since the three continuous monitors are constantly evaluating, they will be reported as “Ready” all of the time. If the testing of a particular supported non-continuous monitor has not been completed, the monitor status will be reported as “Not Complete” or “Not Ready.”

In order for the OBD monitor system to become ready, the vehicle should be driven under a variety of normal operating conditions. These operating conditions may include a mix of highway driving and stop and go, city type driving, and at least one overnight-off period. For specific information on getting your vehicle’s OBD monitor system ready, please consult your vehicle Owner’s Manual.

OBDII Definitions

Power-train Control Module (PCM) — OBDII terminology for the on-board computer that controls engine and drive train.

Malfunction Indicator Light (MIL) — Malfunction Indicator Light (Service Engine Soon, Check Engine) is a term used for the light on the instrument panel. It is to alert the driver and/or the repair technician that there is a problem with one or more of vehicle’s systems and may cause emissions to exceed federal standards. If the MIL illuminates with a steady light, it indicates that a problem has been detected and the vehicle should be serviced as soon as possible. Under certain conditions, the dashboard light will blink or flash. This indicates a severe problem, and flashing is intended to discourage vehicle operation. The vehicle onboard diagnostic system cannot turn the MIL off until necessary repairs are completed or the condition no longer exists.

DTC — Diagnostic Trouble Codes (DTCs) identify which section of the emission control system has malfunctioned.

Enabling Criteria — Also termed Enabling Conditions. They are the vehicle-specific events or conditions that must occur within the engine before the various monitors will set, or run. Some monitors require the vehicle to follow a prescribed “drive cycle” routine as part of the enabling criteria. Drive cycles vary among vehicles and for each monitor in any particular vehicle.

OBDII Drive Cycle — A specific mode of vehicle operation that provides conditions required to set all the readiness monitors applicable to the vehicle to the “ready” condition. The purpose of completing an OBDII drive cycle is

to force the vehicle to run its onboard diagnostics. Some form of a drive cycle needs to be performed after DTCs have been erased from the PCM's memory or after the battery has been disconnected. Running through a vehicle's complete drive cycle will "set" the readiness monitors so that future faults can be detected. Drive cycles vary depending on the vehicle and the monitor that needs to be reset. For vehicle specific drive cycle, consult the vehicle Owner's Manual.

Freeze Frame Data — When an emissions related fault occurs, the OBDII system not only sets a code but also records a snapshot of the vehicle operating parameters to help identify the problem. This set of values is referred to as Freeze Frame Data and may include important engine parameters such as engine RPM, vehicle speed, air flow, engine load, fuel pressure, fuel trim value, engine coolant temperature, ignition timing advance, or closed loop status.

OBDII Modes of Operation

Here is a basic introduction to the OBDII communications protocol.

Mode Byte: The first byte in the stream is the mode number. There are 10 modes for diagnostic requests. The first byte in the response data bytes is this same number plus 64. For example, a mode 1 request would have the first data byte = 1, and the response would have the first data byte = 65. Here is a brief description of the modes:

Mode \$01 — Identifies the Power-train information and shows the current data available to the scan tool. This data includes: DTC set, status of on-board tests, and vehicle data such as engine RPM, temperatures, ignition advance, speed, air flow rates, and closed loop status for fuel system.

Mode \$02 — Displays Freeze Frame data. Same data as in mode 1, but it was captured and stored when a malfunction occurred and a DTC was set. Some of the PIDs for mode one are not implemented in this mode.

Mode \$03 — Displays the type of power-train or emission related DTCs stored by a 5-digit code identifying the faults. There may be more than one response message if there are more trouble codes fit in the data bytes of the response message, or if there are more than one ECU responding.

Mode \$04 — Used to clear DTCs and freeze frame data. This clears all diagnostic trouble codes that may be set including freeze frame data and readiness monitors.

Mode \$05 — Displays oxygen sensor test results. This mode displays the oxygen sensor monitor screen and the test results gathered about the oxygen sensor.

There are nine terms available for diagnostics:

1. \$01 Rich-to-Lean O₂ sensor threshold voltage.
2. \$02 Lean-to-Rich O₂ sensor threshold voltage.
3. \$03 Low sensor voltage threshold for switch time measurement.
4. \$04 High sensor voltage threshold for switch time measurement.
5. \$05 Rich-to-Lean switch time in ms.
6. \$06 Lean-to-Rich switch time in ms.
7. \$07 Minimum voltage for test.
8. \$08 Maximum voltage for test.
9. \$09 Time between voltage transitions in ms.

Mode \$06 — Non-continuously Monitored Systems test results. There are typically a minimum value, a maximum value, and a current value for each non-continuous monitor. This data is optional, and it is defined by a given vehicle maker if it's used.

Mode \$07 — A request for DTCs (pending) from Continuously Monitored Systems after a single driving cycle has been performed to determine if repair has fixed a problem. This is used by service technicians to verify whether repair was performed properly after diagnostic trouble codes are cleared.

Mode \$08 — This special Control Mode requests control of the on-board system, test, or component bi-directionally (where applicable). The mode is manufacturer-specific.

Mode \$09 — Reports vehicle information. This information includes vehicle VIN number and calibration information stored in the vehicle ECUs.

Mode \$0A — Requests Emissions-Related Diagnostic Trouble Codes with Permanent Status. This mode is required for all emissions-related DTCs. The presence of permanent DTCs during an inspection without the MIL illuminated is an indication that a proper repair was not verified by the on-board monitoring system.

3 Using the Scan Tool

Tool Description

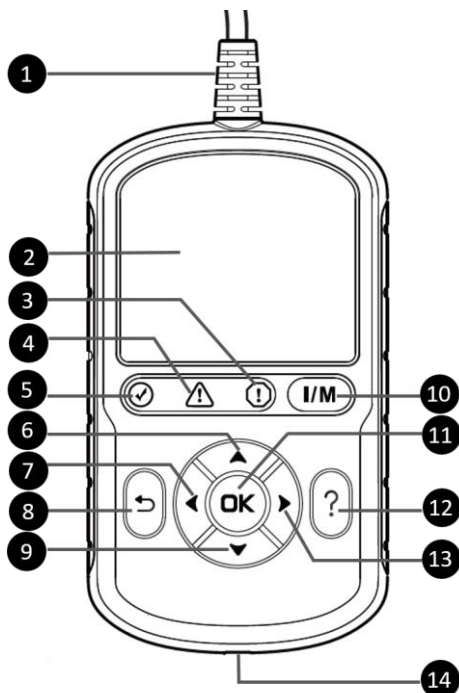











Figure 3-1 Product View

- 1) **OBDII CONNECTOR** — connects the scan tool to the vehicle's Data Link Connector (DLC).
- 2) **LCD DISPLAY** — displays menus and test results.
- 3) **! RED LED** — indicates there is a problem in one or more of the vehicle's systems. The red LED also indicates DTCs are present. DTCs displayed on the scan tool's display. In this case, the MIL on the vehicle's instrument panel will illuminate.

- 4)  **YELLOW LED** — indicates there is a possible problem. A “Pending” DTC is present and/or some of the vehicle’s emission monitors have not run their diagnostic testing.
- 5)  **GREEN LED** — indicates that engine systems are running normally (The monitors on the vehicle are active and the number of monitors which are performing their diagnostic testing is in the allowed limit, and no DTCs are present).
- 6)  **UP SCROLL BUTTON** — moves up menu and submenu items in menu mode. When more than one screen of data is retrieved, press to scroll to the previous screens. When looking up DTC, it is used to change the value of the selected character.
- 7)  **LEFT SCROLL BUTTON** — selects/deselects PID data when viewing or recording customized live data list and views previous frames of recorded data when playing back live data. Press to update DTC library in Update Mode. When looking up DTC definitions, press to view the previous character and to display additional information on previous screens if present.
- 8)  **ESC BUTTON** — cancels a selection (or action) from a menu or returns to the previous screen.
- 9)  **DOWN SCROLL BUTTON** — moves down menu and submenu items in menu mode. When more than one screen of data is retrieved, press to move down through the current screen to next screens. When looking up DTC, it is used to change the value of the selected character.
- 10)  **ONE-CLICK I/M READINESS KEY** — quick-checks State Emissions readiness and drive cycle verification.
- 11) **OK BUTTON** — confirms a selection (or action) from a menu.
- 12)  **HELP BUTTON** — displays help information and accesses DTC Guide function.
- 13)  **RIGHT SCROLL BUTTON** — selects/deselects all marked PID data when viewing or recording customized live data list, and views next frames of data when playing back live data. When viewing DTC definitions, press to view next character and additional DTC information.

- 14) **USB CONNECTOR** — connects the scan tool to the Windows-based PC for printing and upgrading.

Specifications

Table 3-1 Specifications

Item	Description
Display	2.8-inch LCD (320 x 240 dpi)
Connectivity	<ul style="list-style-type: none">● Type C USB● OBDII DB16
Operating Temp.	0 to 60 °C (32 to 140 °F)
Storage Temp.	-20 to 70 °C (-1 to 158 °F)
External Power	8.0 to 18.0 V power provided via vehicle battery
Dimensions (L x W x H)	150.6 mm (5.9") x 85 mm (3.3") x 19.9 mm (0.8")
Weight	<ul style="list-style-type: none">● 275.4 g (with wire)● 166.9 g (without wire)

Accessories Included

- 1) **Quick Reference Guide** — instructions on registering tool and updating software.
- 2) **USB Cable** — used to connect to a Windows-based PC for printing data saved on the tool and to update the tool's software.

Navigation Characters

Characters used to help navigate the scan tool are:

- 1) **\$** — identifies the control module number from data retrieved. Indicates the Test ID in On-Board Monitor Test.
- 2) **?** — indicates help or DTC Guide information is available.
- 3) **G** — indicates graphic viewing is available.

Keyboard

No solvents such as alcohol should be used to clean the keypad or display; use mild non-abrasive detergent and soft cotton cloth instead. Do not soak the keypad as the keypad is not waterproof.

Power

The scan tool is powered via the vehicle Data Link Connector (DLC). Follow the steps below to turn on the scan tool:

- 1) Locate the DLC on the vehicle.
 - A plastic DLC cover may be found on some vehicles and you need to remove it before connecting the OBDII cable.
- 2) Plug the OBDII cable into the vehicle's DLC. The scan tool will automatically power up and the Main Screen appears. (Figure 3-2)

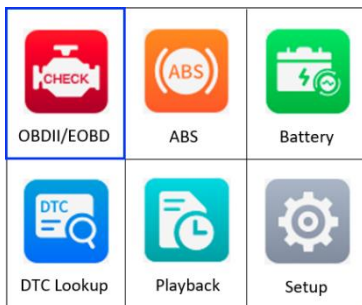

Figure 3-2 Main Screen

Vehicle Coverage

The AutoLink® AL549 OBDII Scanner is specially designed to work with all OBDII compliant vehicles, including those equipped with Control Area Network (CAN) protocol. The EPA requires all domestic, Asian and European vehicles, 1996 and newer vehicles (including light trucks), sold in the United States must be OBDII compliant.

A small number of 1994 and 1995 model year gasoline vehicles are OBDII compliant. To verify if a 1994 or 1995 vehicle is OBDII compliant, check the Vehicle Emissions Control Information (VECI) Label which is located under the hood or by the radiator of most vehicles. If the vehicle is OBDII compliant,

the label will designate “OBDII Certified.” Additionally, government regulations mandate that all OBDII compliant vehicles must have a “common” sixteen-pin DLC.

For your vehicle to be OBDII compliant, it must have a 16-pin DLC under the dash and the Vehicle Emission Control Information Label must state that the vehicle is OBDII compliant.

In addition to OBDII diagnosis, the AL549 scan tool also supports the ABS diagnostics function, dealing with more than 20 US, Asian and European vehicles, including Toyota, Honda, Benz, BWM, Ford, GM, Volkswagen, Audi, Chrysler, Hyundai, Infiniti, Jaguar, Kia, Land Rover, Lexus, Mazda, Mini, Scion, Volvo, Dodge, Lincoln, Acura, and Nissan.

Product Troubleshooting

This section describes problems that may be encountered while using the scan tool.

Vehicle Linking Error

A communication error occurs if the scan tool fails to communicate with the vehicle’s ECU (Engine Control Unit). Do the following steps to resolve the error:

- ✓ Verify that the ignition is ON.
- ✓ Ensure the scan tool’s OBDII connector is securely connected to the vehicle’s DLC.
- ✓ Verify that the vehicle is OBDII compliant.
- ✓ Turn the ignition off and wait for about 10 seconds. Turn the ignition on again and continue the testing.
- ✓ Verify the control module is not defective.

Operating Error

If the scan tool freezes, then an exception occurs or the vehicle’s ECU is too slow to respond to requests. You need to do the following steps to reset the tool:

- ✓ Reset the scan tool.

- ✓ Turn the ignition off and wait for about 10 seconds. Turn the ignition on again and continue the testing.

Scan Tool Does Not Power Up

If the scan tool will not power up or operates incorrectly, do the following steps:

- ✓ Check if the scan tool's OBDII connector is securely connected to the vehicle's DLC.
- ✓ Check if the DLC pins are bent or broken. Clean the DLC pins if necessary.
- ✓ Check the vehicle battery to make sure it is still good with at least 8.0 volts.

4 OBDII Diagnostics

The OBDII Diagnostics function is a fast-access option that allows you to carry out a quick test on the engine system of OBDII vehicles.

When more than one vehicle control module is detected by the scan tool, you will be prompted to select the module with retrievable data. The Power train Control Module (PCM) and Transmission Control Module (TCM) are the most commonly scanned modules.

! IMPORTANT

DO NOT connect or disconnect the scan tool while the ignition is on or the engine is running.

- 1) Turn the ignition off.
- 2) Locate the vehicle's 16-pin Data Link Connector (DLC).
- 3) Plug the scan tool into the vehicle's DLC.
- 4) Turn the ignition on. Engine can be off or running.
- 5) Turn on the scan tool. From the Main Screen, use the **UP/DOWN** scroll button and **LEFT/RIGHT** scroll button to select **OBDII/EOBD**.

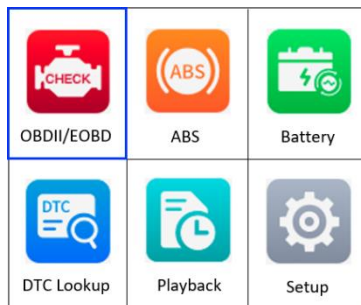

Figure 4-1 Main Screen

- 6) Press the **OK** button and wait for the Menu to display. The tool will display OBDII protocols and the vehicle information when the vehicle's communication protocol is detected.
 - If the scan tool has failed to communicate with the vehicle's ECU (Engine Control Unit) more than three times, a "LINKING ERROR!" message appears on the tool.
 - ✓ Verify the ignition is ON.
 - ✓ Check if the scan tool's OBDII cable is securely connected to the vehicle's DLC.
 - ✓ Verify that the vehicle is OBDII compliant.
 - ✓ Turn the ignition off and wait for about 10 seconds. Turn the ignition back on and repeat step 5.
 - If the "**LINKING ERROR!**" message continues to display, contact your local distributor or customer service for assistance.
- 7) View a summary of the system status (MIL status, DTC counts, monitor status) on screen. Wait a moment or press any key for the Diagnostic Menu to appear.

System Status	
MIL Status	ON
Codes Found	127
Monitors N/A	0
Monitors OK	0
Monitors INC	9

Figure 4-2 System Status Screen

- If more than one module is detected, you will be prompted to select a module before testing.
- Use the **UP/DOWN** scroll button to select a module and press the **OK** button to confirm.

Read Codes

- ◆ The Read Codes function can be performed with the key on engine off (KOEO) or with the key on engine running (KOER).

- ◆ Stored Codes are also known as “hard codes,” which are fault codes, or trouble codes that have been stored in the vehicle computer memory because the faults have reoccurred for more than a specified amount of key-cycles. These codes will cause the control module to illuminate the malfunction indicator light (MIL) when emissions-related faults occur.
 - ◆ Pending Codes are also referred to as “maturing codes” or “continuous monitor codes.” They indicate problems that the control module has detected during the current or last driving cycle but are not as yet considered serious. Pending Codes will not turn on the malfunction indicator light (MIL). If the fault does not occur within a certain number of warm-up cycles, the code clears from memory.
 - ◆ Permanent Codes are DTCs that are “confirmed” and are retained in the non-volatile memory of the vehicle’s computer until the appropriate monitor for each DTC has determined that the malfunction is no longer present and is not causing the MIL. Permanent DTCs are stored in non-volatile memory and cannot be erased by any diagnostics service or by disconnecting power to ECU.
- 1) From the Diagnostic Menu screen, use the **UP/DOWN** scroll button to select **Read Codes** and press the **OK** button.

Diagnostic Menu	1/9
Read Codes	
Erase Codes	
Live Data	
View Freeze Frame	
I/M Readiness	
On-Board Mon. Test	
Component Test	

Figure 4-3 Diagnostic Menu Screen

- 2) Use the **UP/DOWN** scroll button to select **OBD Codes** or **Enhanced Codes** and press the **OK** button.

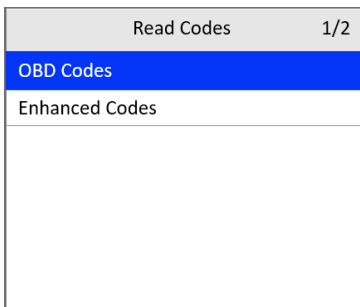

Figure 4-4 Read Codes Screen

- If no codes are found, a message will appear. Wait a moment or press any key to return to the previous screen.

NOTE

Permanent Codes function is available only for vehicles supporting the CAN protocols.

- 3) View DTCs and their definitions.

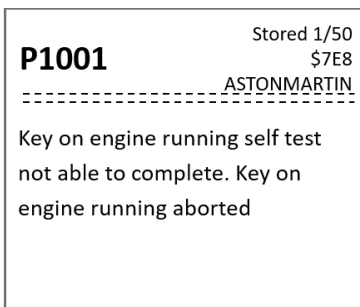

Figure 4-5 DTC Screen

- 4) If more than one DTC is found, use the **UP/DOWN** scroll button to check all codes.
 - If retrieved DTCs contain any manufacturer specific or enhanced codes, the tool's AutoVIN technology will automatically display the definition of the code. Use the **UP/DOWN** scroll button to select a manufacturer and then press the **OK** button to confirm.

Vehicle Manufacturer	1/48
ALFA ROMEO	
ASTONMARTIN	
AUDI	
BENTLEY	
BENZ	
BMW	
BRAZIL GM	

Figure 4-6 *Vehicle Manufacturer Screen*

Erase Codes

NOTE

1. Erasing the Diagnostic Trouble Codes (DTC) may allow the scan tool to delete not only the codes from the vehicle's on-board computer, but also "Freeze Frame" data and manufacturer-specific enhanced data. Further, the I/M Readiness Monitor Status for all vehicle monitors is reset to Not Ready or Not Complete status. Do not erase the codes before repairs or services have been performed.
2. Even if deleted, codes will again display if the underlining fault causing the code is not addressed.

◆ This function is performed with key on, engine off (KOEO). Do not start the engine.

- 1) From the Diagnostic Menu screen (Figure 4-3), use the **UP/DOWN** scroll button to select **Erase Codes** and press the **OK** button.
- 2) A warning message appears for your confirmation.

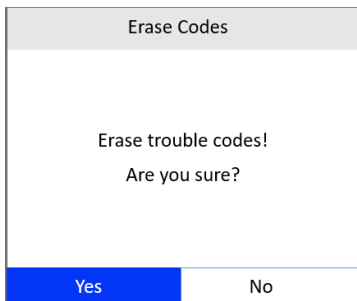

Figure 4-7 Erase Codes Screen 1

- If you do not want to proceed with erasing codes, press the **ESC** button or use the **LEFT/RIGHT** scroll button to select **NO** to exit.
- If you press the **OK** button or use **LEFT/RIGHT** scroll button to select **Yes**, a warning message will come up asking for your confirmation.

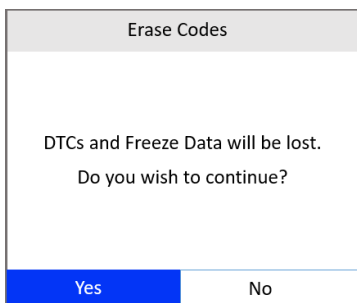

Figure 4-8 Erase Codes Screen 2

- 3) Select **Yes** to confirm. When the command is sent, the tool will display a message.

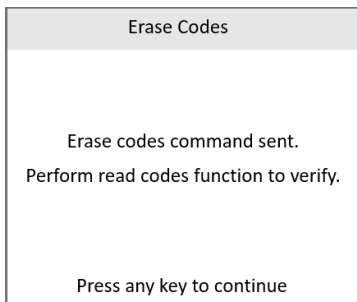

Figure 4-9 Erase Codes Screen 3

- If the codes are cleared successfully, an “**Erase Done!**” confirmation message appears.
 - If the codes are not cleared, then an “**Erase Failure. Turn Key on with Engine off!**” message appears.
- 4) Press any button to return to the Diagnostic Menu.

Live Data

In this function, you can not only read the live data but also record data for later review.

View Data

The View Data function allows viewing of live or real time PID (Parameter Identification) data of vehicle’s computer modules.

- 1) To view live data, use the **UP/DOWN** scroll button to select **Live Data** from the Diagnostic Menu screen (Figure 4-3) and press the **OK** button.
- 2) Wait a few seconds while the scan tool validates the PID MAP.

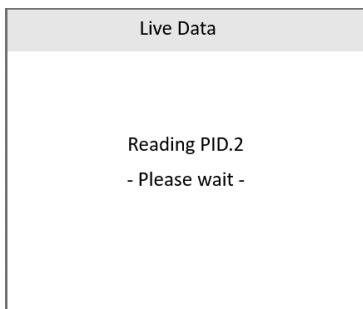

Figure 4-10 Live Data Screen 1

- 3) Use the **UP/DOWN** scroll button to select **View Data** from the Live Data menu and press the **OK** button.

Live Data	1/3
View Data	
Record Data	
Playback Data	

Figure 4-11 Live Data Screen 2

View Complete Data Set

- 1) To view complete set of data, use the **UP/DOWN** scroll button to select **Complete Data Set** from the View Data menu and press the **OK** button.

View Data	1/2
Complete Data Set	
Custom Data Set	

Figure 4-12 View Data Menu

- 2) View live PIDs on the screen. Use the **UP/DOWN** scroll button for more PIDs if additional information is available on more than one page.

G	Complete Data Set	9/38
	MAP(inHg)	28.64
	RPM(rpm)	0.00
	VSS(mph)	0.00
	SPARKADV(°)	0.0
	IAT(°F)	68.00
	MAF(lb/s)	0.00
	TP(%)	17.3

Figure 4-13 Complete Data Set Screen

- The number “x” on the upper-right of the screen indicates the sequence of the highlighted item.
 - To view full name of the highlighted PID, press the “?” **HELP** button.
- 3) Press the **ESC** button to return to the previous menu.

View Custom Data Set

- 1) To view customized PID data, use the **UP/DOWN** scroll button to select **Custom Data Set** from the View Data menu (Figure 4-12) and press the **OK** button.
- 2) Follow the on-screen instructions.

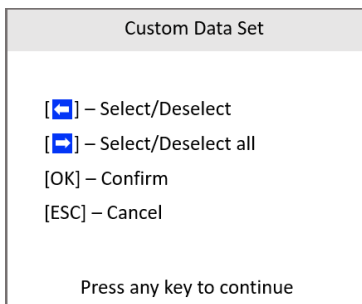

Figure 4-14 Custom Data Set Screen 1

- 3) Use the **LEFT** scroll button to deselect/select data parameters and the **UP/DOWN** scroll button to move up and down. Selected parameters are marked with solid squares.

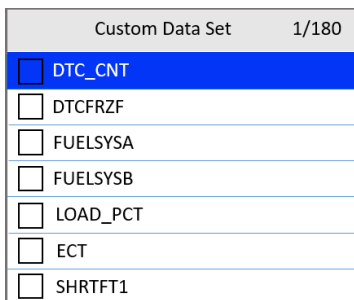

Figure 4-15 Custom Data Set Screen 2

- The number “x” on the upper-right corner of the screen indicates the sequence of the highlighted item.
 - Press the **RIGHT** scroll button to deselect all marked items or select all items. A message appears for your confirmation.
 - If you decide to deselect these items, press **OK**. If you decide not to, press **ESC** or use the **LEFT/RIGHT** scroll button to select **NO** to continue PID selections.
- 4) Press the **OK** button to view selected PIDs on the screen. Use the **ESC** button to return to the previous menu.

Record Data

The Record Data function allows recording vehicle modules' Parameter Identification (PID) data to help diagnose intermittent vehicle problems. A recording includes 5 frames of live data before a trigger event and several frames after a trigger event.

There are two trigger modes used to record data:

- A. **Manual Trigger** — press the **OK** button to start recording.
- B. **DTC Trigger** — automatically records PID data when a fault triggers a DTC on the vehicle.

 **NOTE**

DO NOT drive the vehicle and operate the tool at the same time.

To record live data, use the **UP/DOWN** scroll button to select **Record Data** from Live Data screen (Figure 4-11) and press the **OK** button.

Record Complete Data Set

- 1) To record complete set of live data, use the **UP/DOWN** scroll button to select **Complete Data Set** from Record Data screen and press the **OK** button.

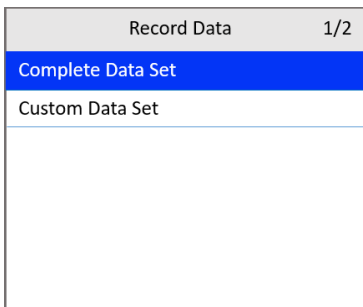

Figure 4-16 Record Data Screen

- 2) Use the **UP/DOWN** scroll button to select a trigger mode and press the **OK** button.

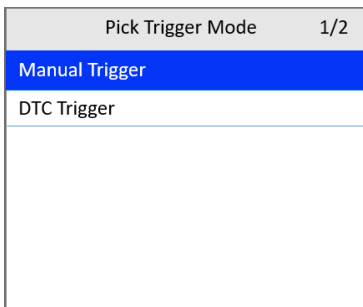

Figure 4-17 Pick Trigger Mode Screen

- If data from a previously tested vehicle is not erased, data from current test will be temporarily stored in the tool's memory.
- 3) Use the **UP/DOWN** scroll button to select a memory location and press the **OK** button.

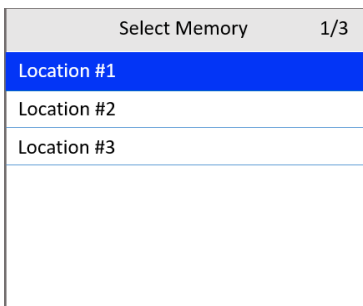

Figure 4-18 Select Memory Screen 1

- The asterisk (*) icon on the screen indicates that a previous recording is stored in the highlighted location.
 - If you select a location marked with an asterisk (*), a message prompting to overwrite old recording appears.
 - If you wish to proceed with overwriting the recording, press the **OK** button; if you do not wish to overwrite it, use the **LEFT/RIGHT** button to select **NO** or press the **ESC** button to pick another memory location.
- 4) Observe the on-screen instructions.

- If **Manual Trigger** is selected, the following screen appears:

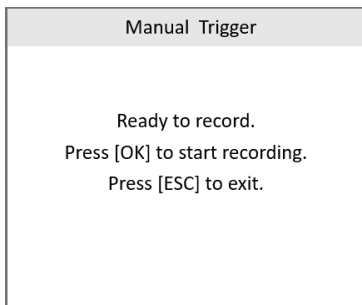

Figure 4-19 Manual Trigger Screen

- If **DTC Trigger** is selected, the following screen appears:

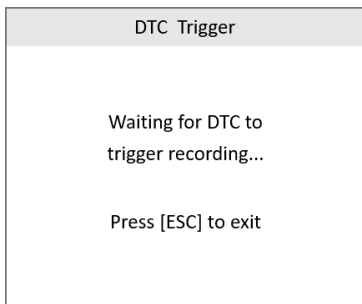

Figure 4-20 DTC Trigger Screen

- 5) Wait for DTC to trigger or press **OK** to start recording.
- ◆ *Drive till a DTC is detected when DTC Trigger is selected. If no DTCs are detected, press **ESC** to exit recording.*

Recording... 0/--	1/242
DTC_CNT	127
DTCFRZF	U3FFF
FUELSYSA	OL
FUELSYSB	OL
LOAD_PCT(%)	100.0
ECT(°C)	215
SHRTFT1(%)	99.2

Figure 4-21 Recording Data Screen

- The number “x/x...” in the upper-right corner of the screen indicates the number of recorded frames out of the maximum frames that can be recorded.
- 6) The scan tool continues to record PID data until the **ESC** button is pressed, the selected memory location is full, or it completes recording. A message will display asking if you want to play back the data.

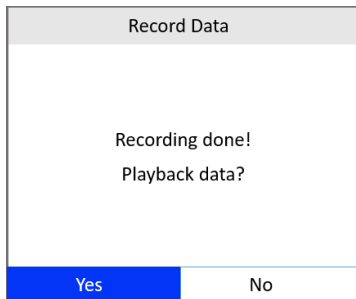

Figure 4-22 Recording Done Screen

- If you wish to play back recorded data, press the **OK** button; if you do not wish to play back, press the **ESC** button, or use the **LEFT/RIGHT** button to select **NO** and press the **OK** button to return to the Record Data screen.

Record Custom Data Set

- 1) To record customized data, use the **UP/DOWN** scroll button to select **Custom Data Set** from the Record Data screen (Figure 4-16) and press the **OK** button.

- 2) Observe the on-screen instructions. Press the **OK** button to continue; press the **ESC** button or the **LEFT/RIGHT** button to select **NO** and press the **OK** button to return to Record Data screen.
- 3) Use the **LEFT** button to select/deselect data parameters. Selected parameters are marked with solid squares. Press the **OK** button to confirm.
 - If you wish to deselect all marked items, press the **RIGHT** button.
 - A message comes up to ask for your confirmation.
 - If you decide to deselect these items, press **OK**; if you decide not to, press the **ESC** button, or use the **UP/DOWN** button to select **NO** and press **OK** to continue PID selections.
- 4) Use the **UP/DOWN** scroll button to select a trigger mode and press the **OK** button.
 - If data from previously tested vehicle is not erased, data from current test will be stored in temporary cache.
- 5) Use the **UP/DOWN** scroll button to select a memory location and press the **OK** button.
- 6) Follow the on-screen instructions to select a DTC trigger mode.
- 7) Wait for DTC to trigger recording or press **OK** to start recording.
- 8) The scan tool continues recording PID data until the user presses the **ESC** button, the selected memory location is full, or it completes recording. A message prompting to play back data shows on the screen.
 - If you wish to play back recorded data, press the **OK** button; if you do not wish to play back, press the **ESC** button, or use the **LEFT/RIGHT** scroll button to select **NO** and press the **OK** button to return to the Record Data screen.

Playback Data

The Playback Data function allows viewing of previously stored PID data.

- 1) To play back recorded data, use the **UP/DOWN** scroll button to select **Playback Data** from Live Data screen (Figure 4-11) and press the **OK** button.
 - You are also allowed to play back recorded data immediately after recording.

- 2) Use the **UP/DOWN** scroll button to select the memory location marked with an asterisk (*).

Select Memory	1/3
Location #1	
Location #2	
Location #3	

Figure 4-23 Select Memory Screen 2

- If there is no recording in selected location, a message “**Not Supported or Stored No Data.**” appears on the screen. Press any key to continue.
- 3) Use the **UP/DOWN** scroll button to view recorded PIDs of each frame.

1 of 2 frame	1/354
DTCFRZF	U3FFF
FUELSYSA	OL
FUELSYSB	OL
LOAD_PCT(%)	100.0
ECT(°C)	215
SHRTFT1(%)	99.2
LONGFT1(%)	99.2

Figure 4-24 Playback Data Screen

- 4) Use the **LEFT/RIGHT** scroll button to view PIDs of next or previous frames.

View Freeze Frame

Freeze Frame Data allows the technician to view the vehicle’s operating parameters at the moment a DTC is detected. For example, the parameters may include engine speed (RPM), engine coolant temperature (ECT), or

vehicle speed sensor (VSS). This information will aid the technician by allowing the parameters to be duplicated for diagnostic and repair purposes.

- 1) To view freeze frame data, use the **UP/DOWN** scroll button to select **View Freeze Frame** from the Diagnostic Menu screen (Figure 4-3) and press the **OK** button.
- 2) Wait while the scan tool validates the PID MAP.
- 3) If retrieved information appears on more than one screen, use the **DOWN** scroll button, as necessary, until all the data has been displayed.

View Freeze Frame		1/39
DTC_CNT		127
DTCFRZF		U3FFF
FUELSYSA		OL
FUELSYSB		OL
LOAD_PCT(%)		100.0
ECT(°C)		215
SHRTFT1(%)		99.2

Figure 4-25 View Freeze Frame Screen

- If no freeze frame data is available, the message “**No freeze frame data stored!**” appears.
- 4) To view the full name of a PID, use the **UP/DOWN** scroll button to select the PID and press the **HELP** button.
 - 5) Press the **ESC** button to return to the previous screen.

I/M Readiness

I/M Readiness function is used to check the operations of the Emission System on OBDII compliant vehicles. It is an excellent function to use prior to having a vehicle inspected for state emissions compliance.

NOTE

Clearing trouble codes also clears the readiness status for the individual emission system readiness tests. In order to reset these monitors, the vehicle must be driven through a complete drive cycle with no trouble codes in memory. Amount of time needed for reset vary by vehicle.

Some latest vehicle models may support two types of I/M Readiness tests:

- A. **Since DTCs Cleared** — indicates status of the monitors since the DTCs are erased.
- B. **This Driving Cycle** — indicates status of monitors since the beginning of the current driving cycle.

An I/M Readiness Status result of “NO” does not necessarily indicate that the vehicle being tested will fail the state I/M inspection. In some states, one or more such monitors may be allowed to be “Not Ready” to pass the emissions inspection.

There are two ways to retrieve I/M readiness status.

Retrieve I/M Readiness status with One-Click I/M Readiness Key

Press **One-Click I/M Readiness Key** to retrieve the I/M readiness status. The screen will display as below. The LED colors and the audio tones indicate readiness status.

I/M Readiness			
MIL	ON		
DTC	65	PD DTC	4
MIS	x	EVAP	✓
FUE	x	AIR	✓
CCM	✓	O2S	✓
CAT	✓	HRT	✓
HCAT	✓	EGR	✓

Figure 4-26 I/M Readiness Screen

The green, yellow and red LEDs provide a quick way to help you determine if a vehicle is ready for an Emission Test.

- ✓ **OK** — indicates that a particular monitor being checked has completed its diagnostic testing.
- ✗ **INC** — indicates that a particular monitor being checked has not completed its diagnostics test.
- ⊘ **N/A** — the monitor is not supported on the vehicle.

The LED and audio tone are interpreted as below:

LED Interpretation

- **GREEN LED** — indicates that engine systems are “OK” and operating normally (the number of Monitors supported by the vehicle that have run and performed their self-diagnostics test is within the allowed limit. MIL is off). There are neither stored nor pending DTCs. The vehicle is ready for an Emissions Testing, and there is a good possibility that it can be certified.
- **YELLOW LED** — with MIL off, there may be three possible conditions to cause the yellow LED to light.
 - ✧ If a “Stored” DTC is causing the Yellow LED to light, it is still possible that the vehicle will be allowed to be tested for emissions and certified.
 - ✧ If a “Pending” DTC is causing the Yellow LED to light, it is still possible that the vehicle will be allowed to be tested for emissions and certified.
 - ✧ The Yellow LED will also light if the monitors do not complete their tests. Each state’s emissions standards differ on the number of tested monitors needed to meet vehicle emissions compliance.

NOTE

Confer with your automotive technician about the status results of each monitor to determine if the vehicle is ready for your state’s emissions testing.

- **RED LED** — indicates there is a problem with one or more of the vehicle’s system. The test of a vehicle resulting a lit red LED is not ready for an Emissions Testing. The red LED is also an indication that there are DTCs present. The MIL lamp on the vehicle’s instrument panel will light steadily. The problem that is causing the red LED to light must be repaired before an Emissions Testing. It is also suggested that the vehicle be inspected/repared before driving the vehicle further.

If the RED LED lights, there is a problem present in the system(s). In this case, you have the following options:

- ✧ Repair the vehicle yourself. Ensure that you proceed by reading the vehicle service manual and following all procedures and recommendations.

- ✧ Take the vehicle to a professional to have it serviced. The problem(s) causing the red LED to light must be repaired before the vehicle undergoes Emissions Testing.

Audio Tone Interpretation

The audio tone is configured according to the I/M Readiness Status.

Table 4-1 Audio Tone Interpretation

LED Light	Audio Tone	Beeping Interval
Green	Two long beeps	5 seconds
Yellow	Short, long, short beep	5 seconds
Red	Four short beeps	5 seconds

After reading the information, press **ESC** to exit. Other buttons are disabled to prevent misoperation.

Retrieve I/M Readiness status in typical way

- 1) Use the **UP/DOWN** scroll button to select **I/M Readiness** from the Diagnostic Menu screen (Figure 4-3) and press the **OK** button.
- 2) Wait while the scan tool validates the PID MAP.
- 3) If the vehicle supports both types of tests, then both types will be displayed on the screen for selection.

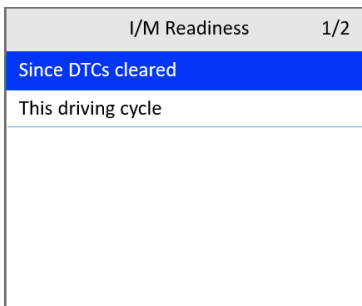

Figure 4-27 I/M Readiness Selection Screen

- 4) Use the **UP/DOWN** scroll button to view the status of the MIL light (**ON** or **OFF**) and the following monitors.

For spark ignition engines:

- **MIS** — Misfire Monitor
- **FUEL** — Fuel System Monitor
- **CCM** — Comprehensive Component Monitor
- **EGR** — EGR System Monitor
- **O2S** — O₂ Sensors Monitor
- **CAT** — Catalyst Monitor
- **EVAP** — Evaporative System Monitor
- **HTR** — O₂ Sensor Heater Monitor
- **AIR** — Secondary Air Monitor
- **HCAT** — Heated Catalyst Monitor

For compression ignition engines:

- **MIS** — Misfire Monitor
- **FUEL** — Fuel System Monitor
- **CCM** — Comprehensive Component Monitor
- **EGR** — EGR System Monitor
- **HCCAT** — NMHC Catalyst Monitor
- **NCAT** — NO_x Aftertreatment Monitor
- **BP** — Boost Pressure System Monitor
- **EGS** — Exhaust Gas Sensor Monitor
- **PM** — PM Filter Monitor

Since DTCs cleared	1/10
MIL	ON
MIS	INC
FUEL	INC
CCM	INC
HCCAT	INC
NCAT	INC
BP	INC

Figure 4-28 Since DTC Cleared Screen

- 5) If the vehicle supports readiness test of **This Driving Cycle**, the following screen appears.

This driving cycle	1/9
MIS	INC
FUEL	INC
CCM	INC
HCCAT	INC
NCAT	INC
BP	INC
EGS	INC

Figure 4-29 This Driving Cycle Screen

- 6) The LEDs and audio tone corresponding to different monitor status will sound as below.

Table 4-2 LED and Audio Tone Description

LED Light	Audio Tone	Beeping Interval
Green	Two long beeps	2 minutes
Yellow	Short, long, short beep	2 minutes
Red	Four short beeps	2 minutes

- 7) Use the **UP/DOWN** scroll button for more PIDs if additional information is available on more than one page. Or use the **LEFT/RIGHT** scroll button to view PIDs in the previous/next page.
- 8) Press the **ESC** button to return to the Diagnostic Menu.

On-Board Monitor Test

The On-Board Monitor Test is useful after servicing or erasing a vehicle's control module memory. The On-Board Monitor Test for non-CAN-equipped vehicles retrieves and displays test results for emissions-related power train components and systems that are not continuously monitored. The On-Board Monitor Test for CAN-equipped vehicles retrieves and displays test results for emissions-related power train components and systems that are continuously monitored or not.

The scan tool allows access to the results of on-board diagnostic monitoring tests for specific components/systems. The vehicle manufacturer is responsible for assigning "Manufacturer Defined Test IDs" and Component

IDs for tests of different systems and components. The advanced feature of this scan tool enables you to read the definition of an On-Board Diagnostic Monitor ID.

NOTE

The scan tool will display a test definition if one is present in the vehicle's computer memory. If no such definition is present, the scan tool will only display the Test IDs.

In this test, there are typically a minimum value, a maximum value, and a current value for each monitor. By comparing the current value with the minimum and maximum values, the scan tool determines if the components and monitors are normal.

- 1) Use the **UP/DOWN** scroll button to select **On-Board Mon. Test** from the Diagnostic Menu screen (Figure 4-3) and press the **OK** button.
- 2) Wait while the scan tool validates the PID MAP.
- 3) The scan tool will prompt you to select the vehicle make.
- 4) After you select the vehicle manufacturer, the scan tool displays the On-Board Monitors test results for specific monitored systems.

On-Board Mon. Test	1/8
Test \$01	
Test \$02	
Test \$03	
Test \$04	
Test \$05	
Test \$06	
Test \$07	

Figure 4-30 On-board Monitor Test Screen 1

- 5) From On-Board Monitor Test menu, use the **UP/DOWN** scroll button to select a test to view and press the **OK** button. Or, use the **LEFT/RIGHT** scroll button to view previous/next screen of test items.
 - If the vehicle being tested does not support the mode, an advisory message will display on the screen.
 - For CAN-equipped vehicles, test selections may be as depicted below:

On-Board Mon. Test	1/6
EGS Mon. B1S1	
EGS Mon. B1S2	
Catalyst Mon. B1	
EGR Monitor Bank 1	
EGR Heater Mon. B1S1	
EGR Heater Mon. B1S2	

Figure 4-31 On-board Monitor Test Screen 2

- Use the **UP/DOWN** scroll button to select the desired monitor from On-Board Mon. Test menu and press the **OK** button.
- View test data on the screen.

Lean-Rich Threshold	1/4
Test Value(V)	0.5246
Min Limit(V)	0.5246
Max Limit(V)	0.5246
Status	OK

Figure 4-32 On-board Monitor Test Screen 3



NOTE

If the On-Board Monitor Test fails, the monitor item will display red.

EGS Mon. B1S1	1/9
Rich-Lean Threshold	
Lean-Rich Threshold	
Low for Switch	
High for Switch	
Rich-Lean Switch	
Lean-Rich Switch	
Test \$80	

Figure 4-33 On-board Monitor Test Screen 4

- 8) Press the **ESC** button to return to the previous menu.

Component Test

The Component Test initiates a leak test for the vehicle's EVAP system. The scan tool itself does not perform the leak test, but commands the vehicle's on-board computer to start the test. Different vehicle manufacturers might use different criteria and methods for stopping the test once it has been started. Before starting the Component Test, refer to the vehicle service manual for instructions to stop the test.

- 1) Use the **UP/DOWN** scroll button to select **Component Test** from the Diagnostic Menu screen (Figure 4-3) and press the **OK** button.
- 2) Wait for the scan tool to display the Component Test menu.

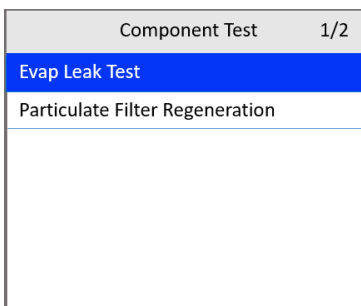

Figure 4-34 Component Test Screen 1

- 3) If the test has been initiated by the vehicle, a confirmation message will be displayed on the screen.

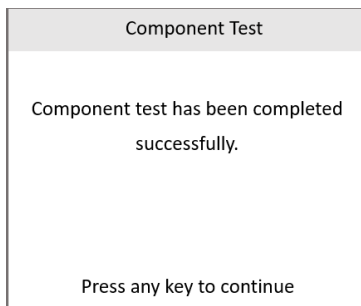

Figure 4-35 Component Test Screen 2

- Some vehicles do not allow scan tools to control vehicle systems or components. If the vehicle under test does not support the EVAP Leak Test, a message will show.

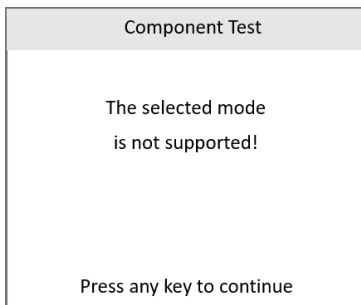

Figure 4-36 Component Test Screen 3

- 4) Wait a few seconds or press any key to return to the previous screen.

Vehicle Information

The Vehicle Information function enables the retrieval of the Vehicle Identification No. (VIN), Calibration ID Nos. (CINs), Calibration Verification Nos. (CVNs) and In-use Performance Tracking on 2000 and newer vehicles that support Mode 9.

- 1) From the Diagnostic Menu screen (Figure 4-3), use **UP/DOWN** scroll button to select **Vehicle Info.** and press the **OK** button.
- 2) A message appears to remind you to “Turn key on with engine off.” Wait a few seconds or press any key to continue.

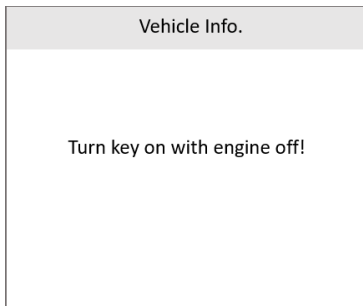

Figure 4-37 Vehicle Info. Screen 1

- 3) Wait while the scan tool reads vehicle information.
 - If the vehicle does not support this mode, a message shows on the display warning that the mode is not supported.
- 4) From the Vehicle Info. menu, use the **UP/DOWN** scroll button to select an item available for viewing and press the **OK** button.

Vehicle Info.		1/3
Vehicle ID Number		
Calibration ID		
Cal. Verf. Number		

Figure 4-38 Vehicle Info. Screen 2

- 5) View the retrieved vehicle information.

Vehicle ID Number	
Manufacturer	ASTONMARTIN
Year	2006
VIN	SCFBB03*****

Figure 4-39 Vehicle Info. Screen 3

- 6) Press the **ESC** button to return to the previous menu.

Modules Present

The Modules Present function displays the module IDs and communications protocols for OBDII modules in the vehicle.

- 1) From the Diagnostic Menu screen (Figure 4-3), use the **UP/DOWN** scroll button to select **Modules Present** and press the **OK** button.
- 2) View modules present with their IDs and communications protocols.

Modules Present	
ID	Protocol
Engine	CAN STD FAST

Figure 4-40 Modules Present Screen

- 3) Press the **ESC** button to return to the previous menu.

5 ABS Diagnosis

The ABS — Anti-lock Braking System in most vehicles is made up of an electronic hydraulic pump of two to four Wheel Speed Sensors (WSS), a G-force sensor, a Vehicle Speed Sensor, and an ABS Control Module (EBCM). The EBCM is constantly monitoring the WSS, the Vehicle Speed Sensor, and the G-sensor.

Diagnosing an ABS problem should always start with a visual inspection of all brake components. Then you will need to retrieve ABS DTCs to tell you where the problem is.

The ABS diagnostic function is used to retrieve and clear codes from the vehicle's Anti-lock Braking System. It also provides the definition of each code to help diagnosing problems within the system that may cause the Malfunction Indicator Light (MIL) to turn on.

❗ IMPORTANT

Autel accepts no responsibility for any accident or injury arising from servicing the ABS system. When interpreting DTCs retrieved from the vehicle, always follow the manufacturer's recommendation for repair.

🔧 NOTE

All screens shown in this manual are examples, actual test screens may vary for each vehicle being tested. Observe the menu titles and on-screen instructions to make correct option selections.

Please follow these steps to start the ABS diagnostics test procedure:

- 1) Turn the ignition off.
- 2) Locate the vehicle's 16-pin Data Link Connector (DLC). Plug the scan tool cable connector into the vehicle's DLC.
- 3) Turn the ignition on, but do not start the engine.
- 4) The scan tool powers up and the Main Screen appears.
- 5) From the Main Screen, use the **UP/DOWN** scroll button and **LEFT/RIGHT** scroll button to select **ABS**.

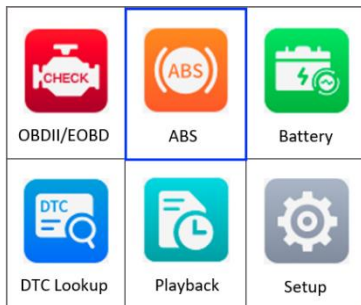

Figure 5-1 Main Screen

Vehicle Selection

The scan tool will communicate with the vehicle and a series of vehicle identification screens appears for users to identify the vehicle. On each screen, use the **UP/DOWN** scroll button to select the correct option and then press the **OK** button. Do this until the vehicle is identified.

- 1) After selecting **ABS** from the Main Screen, use the **UP/DOWN** scroll button to select a region.

Area	1/3
USA Vehicles	
European Vehicles	
Asian Vehicles	

Figure 5-2 Vehicle Area Screen

- 2) Use the **UP/DOWN** scroll button to select the vehicle make. Follow the on-screen instructions, select the vehicle information, such as vehicle model, year, type, and series, if needed.

Vehicle	1/5
Chrysler	
Dodge	
Ford	
Lincoln	
GM	

Figure 5-3 Vehicle Make Selection Screen

- 3) The scan tool will establish a communication link with the test vehicle. Once the communication has been established successfully, the ABS Function screen appears.



Figure 5-4 Communication Screen

- If the scan tool fails to communicate with the vehicle's ECU, a "LINK ERROR!" message appears on the tool.
 - ✓ Make sure the ignition is ON.
 - ✓ Check if the scan tool is securely connected to the vehicle's DLC.
 - ✓ Check that the vehicle battery is charged.

Reading ABS Codes

This function allows users to read the ABS DTCs from vehicle ECU.

- 1) Follow [Vehicle Selection](#) procedure to enter the vehicle information. The scan tool displays a function screen.

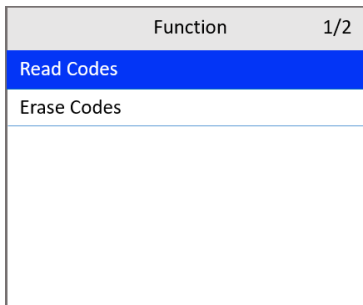

Figure 5-5 ABS Function Screen

- 2) Use the **UP/DOWN** scroll button to select **Read Codes** and press the **OK** button.
- 3) View the DTC and its definition on the screen. Press the **ESC** button to exit.

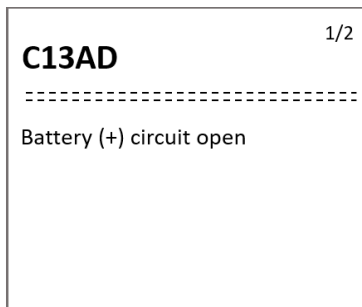

Figure 5-6 ABS Code Screen

Erasing ABS Code

This function allows user to erase the ABS DTCs in vehicle ECU.

NOTE

If you plan to take the vehicle to a Service Center for repair, **DO NOT** erase the ABS DTCs from the vehicle's computer. If the codes are erased, valuable information that might help the technician troubleshoot the problem will also be erased.

- 1) Follow [Vehicle Selection](#) procedure to enter the vehicle information. The scan tool displays a function screen.
- 2) Use the **UP/DOWN** scroll button to select **Erase Codes** and press the **OK** button.
- 3) Follow the on-screen instructions and make sure the ignition is on and engine is off. Press **Yes** to continue.
- 4) A warning message will pop up asking for your confirmation. Use the **LEFT/RIGHT** scroll button to select **Yes** to confirm or **No** to exit.

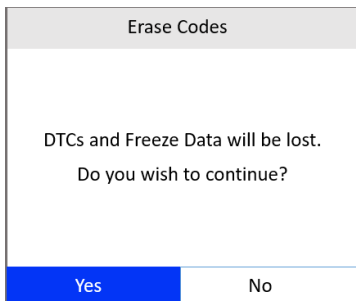

Figure 5-7 Erase Codes Screen 1

- 5) When the command is sent, a message "**Codes erased.**" appears on the tool, indicating the codes are erased successfully. Press any key to continue.

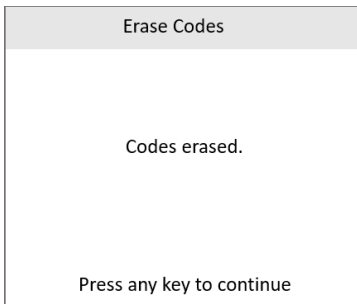

Figure 5-8 Erase Codes Screen 2

- 6) To make sure the codes are erased completely, perform the Read Codes function to verify.

6 Battery Test

The Battery Test function is used to test the vehicle's starting system and charging system. It provides a quick and accurate check of the vehicle's battery and alternator system to ensure the system is operating properly.

Starting System Test

Before performing the test, the starting system should be visually inspected for physical defects, and some preliminary checks should be performed to aid you in diagnosing a starting system problem. These should be taken care of during the pretest.

Pretest

1. To prevent possible personal injury and protect the vehicle from damage, inspect the starting system for defects. Check for the followings, and then repair and/or replace any defective components.
 - Battery defects.
 - Frayed or broken electrical wiring.
 - Corroded or loose connections.
 - Loosely mounted starter motor, series-parallel switch, magnetic switch, solenoid, and starter relay, etc.
2. Check State of Charge (SoC) of battery. For accurate cranking voltage test results, the battery must be at least 75 percent charged.
3. Make sure the handbrake on and the gear is on N or P.

Test Procedure

Follow the steps to complete the test:

- 1) Perform the pretest.
- 2) Turn off all of the vehicle's electrical accessories.

- 3) Connect the scan tool to the vehicle's DLC with the OBDII connector. The scan tool will power up and the Main Screen will appear.

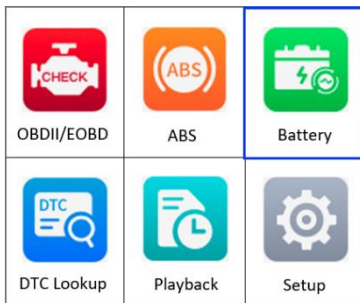

Figure 6-1 Main Screen

- 4) Use the **UP/DOWN** scroll button to select **Battery** from the Main Screen and press the **OK** button.
- 5) Use the **UP/DOWN** scroll button to select **Starting System Test** and press the **OK** button.

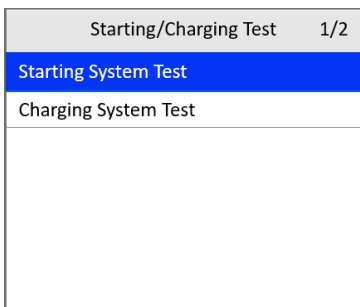

Figure 6-2 Starting/Charging Test Screen

- 6) Read the on-screen preparations and notes. Use the **LEFT/RIGHT** scroll button to select **Yes** or press **OK** to continue.
- 7) Turn on the headlamp. Use the **LEFT/RIGHT** scroll button to select **Yes** or press **OK** to continue.

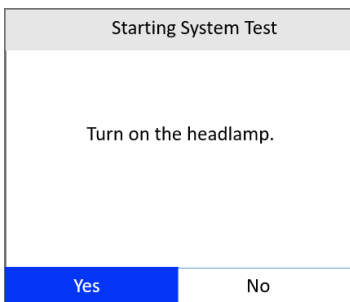

Figure 6-3 Starting System Test Screen 1

- 8) A "countdown" message shows while the battery test is in process. Wait for a few seconds to show the next screen.
- 9) Turn off the headlamp. Use the **LEFT/RIGHT** scroll button to select **Yes** or press **OK** to continue.

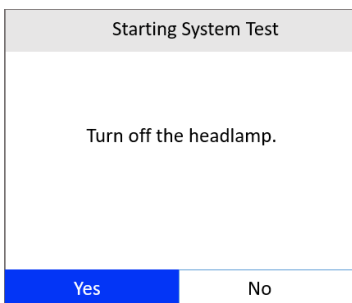

Figure 6-4 Starting System Test Screen 2

- 10) Start the engine in 30 seconds.

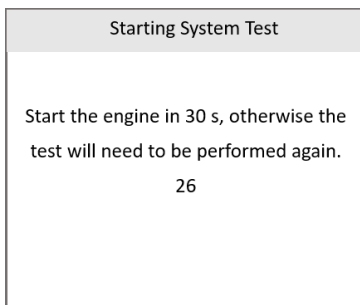

Figure 6-5 Starting System Test Screen 3

- The test needs to be performed again if the engine has not been started within 30 seconds.
- 11) When the battery test is completed, a results screen shows the battery status. Press the **ESC** button to return to the previous menu.

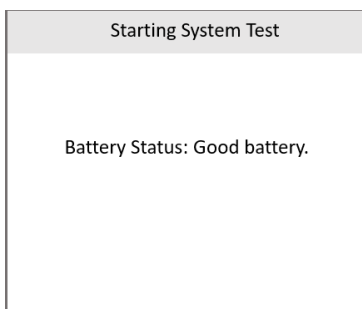

Figure 6-6 Starting System Test Screen 4

- If the test fails, a **“Battery test cannot be performed”** message will appear on the screen. You will need to try again.

Table 6-1 Starting System Test Results

Results	Description
Battery Good	The battery is normal and ready for service.
Charge Battery	Fully charge the battery and retest. Failure to fully charge the battery before testing may cause false readings. If “Charge Battery” appears again after you fully charge the battery, replace the battery.
Battery Faulty	Replace the battery and retest.

Charging System Test

Before starting the test, inspect the alternator drive belt. A belt that is glazed, worn, or lacks the proper tension will prevent the engine from achieving the RPM levels needed for the test.

Test Procedure

- 1) Turn off all the vehicle's electrical accessories.
- 2) Connect the scan tool to the vehicle's DLC with the OBDII connector. The scan tool will power up and the Main Screen will appear.
- 3) Use the **UP/DOWN** scroll button to select **Battery** from the Main Screen (Figure 6-1) and press the **OK** button.
- 4) Use the **UP/DOWN** scroll button to select **Charging System Test** from the Starting/Charging Test screen (Figure 6-2) and press the **OK** button.
- 5) Start the engine and turn on the headlamp. Use the **LEFT/RIGHT** scroll button to select **Yes** or press **OK** to continue.

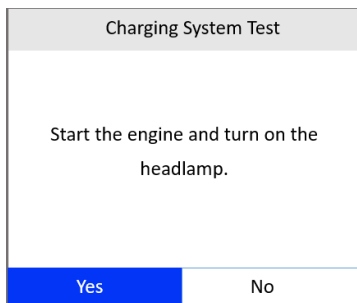

Figure 6-7 Charging System Test Screen 1

- 6) Press the accelerator pedal to increase the engine speed to 2,000 RPM and hold it there until the countdown reaches zero.

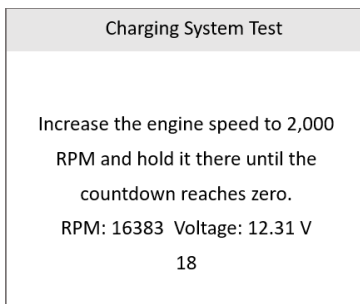

Figure 6-8 Charging System Test Screen 2

- 7) Turn off the headlamp. Release the accelerator and return the engine to idle speed. Use the **LEFT/RIGHT** scroll button to select **Yes** or press **OK** to continue.

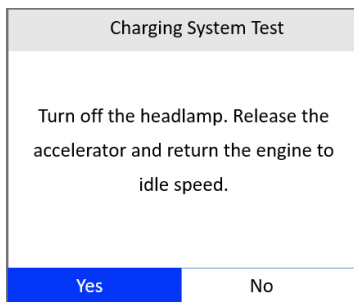

Figure 6-9 Charging System Test Screen 3

- 8) When the Charging System Test is complete, a results screen will display the alternator status and the value of the charging system voltage. Press the **ESC** button to return to the previous menu.

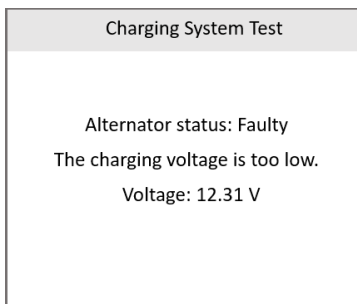

Figure 6-10 Charging System Test Screen 4

Table 6-2 Charging System Test Results

Results	Description
Normal	The charging system is showing normal output. No problem detected.
Low Output	<p>There is a problem with the charging system. The alternator is not providing enough current to power the system's electrical loads and charge the battery.</p> <ul style="list-style-type: none"> ✧ Check the belts to ensure the alternator is rotating with the engine running. Replace broken or slipping belts and retest. ✧ Check the connections between the alternator and the battery. If connection is loose or heavily corroded, clean or replace the cable and retest.
High Output	<p>There is a problem with the charging system. The voltage output from the alternator to the battery exceeds the normal limits of a functioning regulator.</p> <ul style="list-style-type: none"> ✧ Check to ensure there are no loose connections and that the ground connection is normal. ✧ If the connection is good, check the regulator. <p>NOTE: Most alternators have a built-in regulator requiring you to replace the alternator. In older vehicles that use external voltage regulators, you may need to replace only the voltage regulator.</p>

7 DTC Lookup

The DTC Lookup function is used to search for definitions of DTCs stored in the DTC library.

- 1) From the Main Screen, use the **UP/DOWN** scroll button and **LEFT/RIGHT** scroll button to select **DTC Lookup** and press the **OK** button.

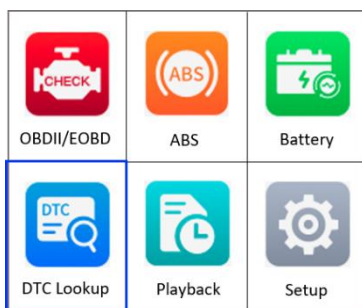

Figure 7-1 Main Menu

- 2) From the DTC Lookup screen, use the **LEFT/RIGHT** scroll button to move to the desired character; use the **UP/DOWN** scroll button to change selected digit/character and press the **OK** button to confirm.

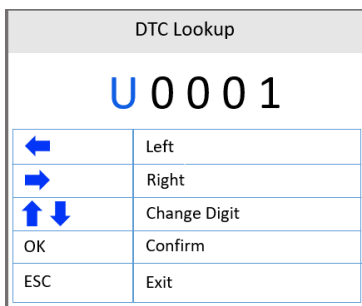

Figure 7-2 Sample DTC Lookup Screen

- 3) View the DTC definition on the screen. When a DTC definition has more than one screen, use the **LEFT/RIGHT** scroll button or **UP/DOWN** scroll button to view additional information on previous/next screens.
 - If retrieved DTCs contain any manufacturer specific codes, the AutoVIN function embedded in this tool will automatically display the definition of the code. Press any key to select a vehicle make.
 - If definition cannot be found, the scan tool displays the message **“Please refer to vehicle service manual.”**
 - For DTC Guide information, press the **“?” HELP** button.
- 4) Use the **LEFT/RIGHT** scroll button to view previous or next DTC in the built-in DTC library.
- 5) To enter another DTC, press the **ESC** button to return to previous screen.
- 6) Press the **ESC** button To exit to the Main Screen.

8 Playback

The Playback function allows the viewing and printing of data from the last recorded test.

Review Data

- 1) From the Main Screen, use the **UP/DOWN** scroll button and **LEFT/RIGHT** scroll button to select **Playback**, and then press the **OK** button.

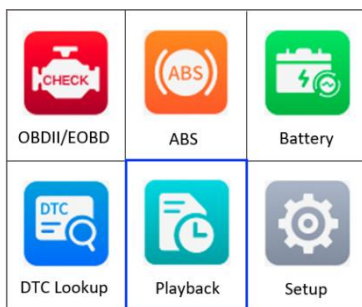

Figure 8-1 Main Screen

- 2) Select **Review Data** and press the **OK** button.

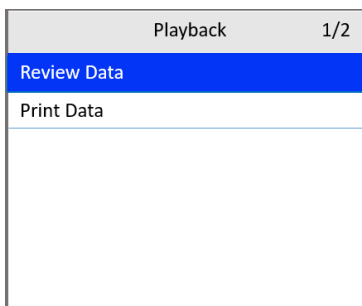

Figure 8-2 Playback Screen

- 3) From the Review Data menu, use the **UP/DOWN** scroll button to select the desired item and press **OK**.

Review Data	1/5
View Freeze Frame	
I/M Readiness	
On-Board Mon. Test	
Vehicle Info.	
Modules Present	

Figure 8-3 Review Data Menu

- If no data from a previously tested vehicle is recorded, only the Modules Present data containing module ID and protocol type can be viewed.
 - Diagnostics results can be reviewed from this list only when trouble codes are detected in previous tests.
- 4) View the selected data on the screen or press the **ESC** button to exit.

View Freeze Frame	1/39
DTC_CNT	127
DTCFRZF	U3FFF
FUELSYSA	OL
FUELSYSB	OL
LOAD_PCT(%)	100.0
ECT(°C)	215
SHRTFT1(%)	99.2

Figure 8-4 View Freeze Frame Screen



NOTE

If there is no data stored for selected item, a “**Not Supported or Stored No Data!**” message appears on the screen.

Print Data

The Print Data function allows the printing of DTC data recorded by the tool by connecting the tool to a Windows-based PC with the supplied USB cable.

NOTE

The print function is currently not available on the Mac OS.

1. Download the **Maxi PC Suite** from www.autel.com > *Support* > *Downloads* > *Autel Update Tools*, and install to your Windows-based computer.
2. Connect the tool to the computer using a Type-C USB cable.
3. Run **Printer** software on the computer.
4. Select **Playback** on the Main Screen of the tool. On the Playback screen, select **Print Data** and then select the data you want to print. Wait for the review window to display, and then select the **Print** function. The selected file will be uploaded to your computer.
5. The **Printer** will appear as below.

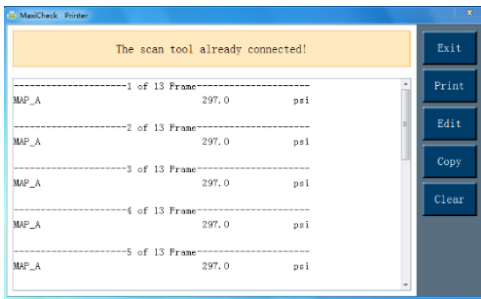

Figure 8-5 Printer Screen

6. The selected data will display in the textbox. Select the appropriate function button on the right to execute one of the following operations:
 - **Print** — print all data in the textbox to a printer connected to your computer.
 - **Edit** — display an editable NOTEPAD window with recorded data.
 - **Copy** — copy the data in the textbox to the clipboard.
 - **Clear** — delete the data in the textbox.
 - **Exit** — quit the operation.

9 Setup

The Setup function allows you to adjust the default settings and view information about the scan tool.

- 1) **Language:** Selects the desired language.
 - 2) **Configure Monitors:** Sets the monitors you want to test.
 - 3) **Unit of measure:** Sets the unit of measure to Imperial or Metric.
 - 4) **Key Beep Settings:** Turns on/off beep.
 - 5) **Status Beep Settings:** Turns on/off the I/M Readiness Status beep.
 - 6) **Tool Self-test:** Checks if the LCD display, LED lamps and keyboard are working normally.
 - 7) **Update Mode:** Accesses the Update Mode.
 - 8) **Set Data Log:** Turns on/off the data log function.
 - 9) **Upload Data Log Mode:** Uploads the data log to the Autel platform.
 - 10) **About:** Provides information of the scan tool.
- *Tool operates with default settings until changed.*

To enter the Setup menu

From the Main Screen, use the **UP/DOWN** scroll button and **LEFT/RIGHT** scroll button to select **Setup** and press the **OK** button. Following the instructions to adjust the settings could make your diagnosis more convenient and easy.

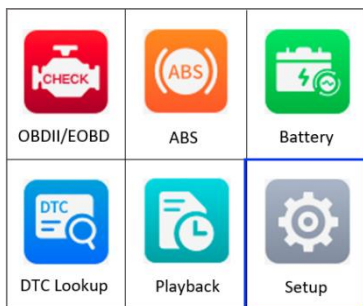

Figure 9-1 Main Screen

Setup	1/10
Language	
Configure Monitors	
Unit of Measure	
Key Beep Set	
Status Beep Set	
Tool Self-test	
Update Mode	

Figure 9-2 Setup Screen

Language

- *English is the default language.*
- 1) From the Setup screen (Figure 9-2), use the **UP/DOWN** scroll button to select **Language** and press the **OK** button.
 - 2) Use the **UP/DOWN** scroll button to select the desired language. Press the **OK** button to save your selection and return to previous screen or press the **ESC** button to exit without saving.

Language	1/3
English	✓
Française	
Español	

Figure 9-3 Language Screen

- More language options may be available when the software has been updated to the latest version.

Configure Monitors

From the Setup screen (Figure 9-2), use the **UP/DOWN** scroll button to select **Configure Monitors** and press the **OK** button.

Configure Monitors	1/4
Spark IGN Required Mon.	
Compression IGN Required Mon.	
Allowed INC Monitors	
Reset Factory Default	

Figure 9-4 Configure Monitors Screen

On this menu, configure the monitors required to test spark ignition and compression ignition, the number of monitors to pass diagnosis, and restore the default settings.

Spark IGN Required Monitors

From the Configure Monitors screen, use the **UP/DOWN** scroll button to select **Spark IGN Required Mon.** and press the **OK** button.

The monitors for spark ignition engines display as follows:

Table 9-1 Spark IGN Required Monitors

Spark IGN Required Monitors			
√	MIS	√	EVAP
√	FUEL	√	AIR
√	CCM	√	O2S
√	CAT	√	HTR
√	HCAT	√	EGR

Compression IGN Required Monitors

From the Configure Monitors screen, use the **UP/DOWN** scroll button to select **Compression IGN Required Mon.** and press the **OK** button.

The monitors for compression ignition engines display as follows:

Table 9-2 Compression IGN Required Monitors

Compression IGN Required Monitors			
√	MIS	√	BP
√	FUEL	√	EGS
√	CCM	√	PM
√	HCCAT	√	EGR
√	NCAT		

Allowed INC Monitors

From the Configure Monitors screen, use the **UP/DOWN** scroll button to select **Allowed INC Monitors** and press the **OK** button.

Emissions tests vary depending on the areas where the vehicle is registered. The scan tool provides a more flexible way to meet different standards by allowing the user to select 0, 1, 2, or 3 “not complete” monitors in test.

Reset Factory Default

From the Configure Monitors screen, use the **UP/DOWN** scroll button to select **Reset Factory Default** and press the **OK** button.

This will restore the default configuration settings in the Configure Monitors menu and delete any customized settings. In this case, Spark IGN Required Monitors and Compression IGN Required Monitors will include all the available monitors, and the Allowed INC Monitors will be set to 1.

The tool will display a message to ask for your confirmation. Select **Yes** to proceed or **No** to exit without saving.

Unit of Measure

- *Metric is the default measurement unit.*
- 1) From the Setup screen (Figure 9-2), use the **UP/DOWN** scroll button to select **Unit of Measure** and press the **OK** button.

- 2) Use the **UP/DOWN** scroll button to select the desired unit of measurement.

Unit of Measure	2/2
Imperial	
Metric	√

Figure 9-5 Unit of Measure Screen

- 3) Press the **OK** button to save your selection and return to the previous menu or press the **ESC** button to exit without saving.

Key Beep Settings

This function allows you to turn on/off the built-in speaker for key pressing.

- *The default setting is Beep On.*
- 1) From the Setup screen (Figure 9-2), use the **UP/DOWN** scroll button to select **Key Beep Settings** and press the **OK** button.
 - 2) Use the **UP/DOWN** scroll button to select **Beep ON** or **Beep OFF** to turn on/off the beep.

Key Beep Settings	1/2
Beep ON	√
Beep OFF	

Figure 9-6 Key Beep Settings Screen

- 3) Press the **OK** button to save your selection and return to the previous menu or press the **ESC** button to exit without saving.

Status Beep Settings

- *The default setting is Beep On.*

This function allows you to turn on/off the built-in speaker as an indicator during diagnostic testing. Different audio tones correspond to different LED lights. This function is useful when performing diagnostics alone, or while working in bright areas where LED illumination alone is not sufficient.

- 1) From the Setup screen (Figure 9-2), use the **UP/DOWN** scroll button to select **Status Beep Settings** and press the **OK** button.
- 2) Use the **UP/DOWN** scroll button to select **Beep ON** or **Beep OFF** to turn on/off the beep.

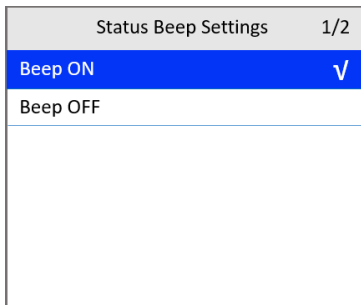

Figure 9-7 Status Beep Settings Screen

- 3) Press the **OK** button to save your selection and return to the previous menu or press the **ESC** button to exit without saving.

Tool Self-test

The Tool Self-test function checks if the display, LED lamps, and keyboard are working properly.

Display Test

The Display Test function checks if the LCD display is working normally.

- 1) From the Setup screen (Figure 9-2), use the **UP/DOWN** scroll button to select **Tool Self-test** and press the **OK** button.
- 2) Select **Display Test** from the Tool Self-test menu and press the **OK** button to start test.

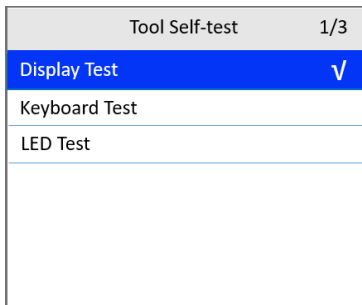

Figure 9-8 Tool Self-test Screen

- 3) When completed, press the **ESC** button to exit.

Keyboard Test

The Keyboard Test function verifies if the keys are functioning properly.

- 1) From the Tool Self-test screen, use the **UP/DOWN** scroll button to select **Keyboard Test**, and then press the **OK** button.
- 2) Press any key to start test. When you press a key, the key name should display on the screen. If the key name does not display, the key is not functioning.

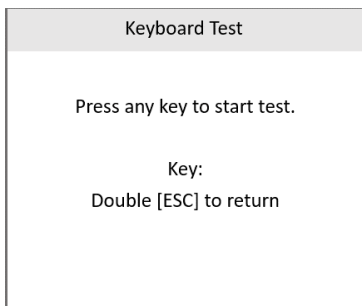

Figure 9-9 Keyboard Test Screen

- 3) Press **ESC** twice to return to the previous menu.

LED Test

The LED Test function verifies if the I/M Readiness LED indicators are functioning properly.

- 1) From the Tool Self-test screen, use the **UP/DOWN** scroll button to select **LED Test**, and then press the **OK** button.
- 2) Use the **UP/DOWN** scroll button to select one or more LED lamps to test. The LED should turn on or off according to the selected commands.

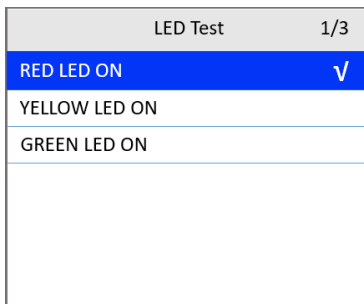

Figure 9-10 LED Self-test Screen

- 3) When completed, press the **ESC** button to exit.

Set Data Log

- *The default setting is OFF.*

If you want to upload the data log to Autel company, please first set the data log to ON.

- 1) From the Setup screen (Figure 9-2), use the **UP/DOWN** scroll button to select **Set Data Log** and press the **OK** button.
- 2) Use the **UP/DOWN** scroll button to select **ON** or **OFF** to turn on/off the data log.

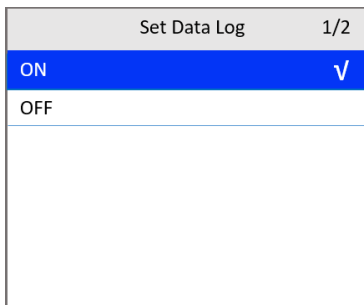

Figure 9-11 Set Data Log Screen

- 3) Press the **OK** button to save your selection and return to the previous menu or press the **ESC** button to exit without saving.

Upload Data Log Mode

This function allows you to upload your data log to Autel company when you encounter a test problem.

- 1) Download the **Maxi PC Suite** from www.autel.com > *Support* > *Downloads* > *Autel Update Tools*, and install to your Windows-based computer.
- 2) Connect the scan tool to your computer with the provided USB cable.
- 3) From the Setup screen (Figure 9-2), use the **UP/DOWN** scroll button to select **Upload Data Log Mode** and press the **OK** button.

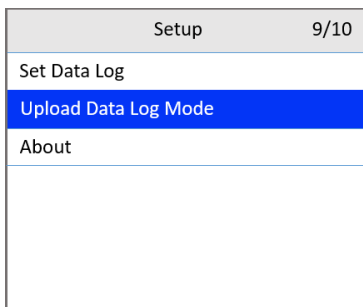

Figure 9-12 Upload Data Log Mode Screen

- 4) Run the **Maxi PC Suite** on your computer. Tap the **Upload** button on the right side of the screen.

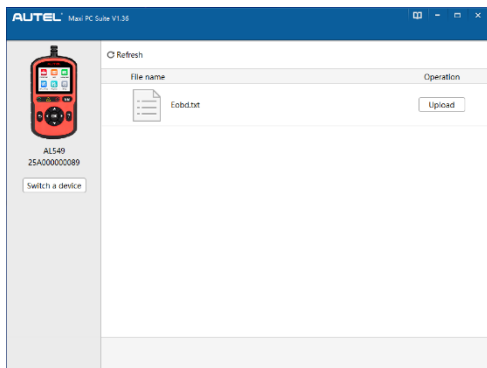

Figure 9-13 Upload Data Log Screen 1

- 5) Enter the required information and then tap **Submit**. Fields marked with an asterisk (*) are mandatory.

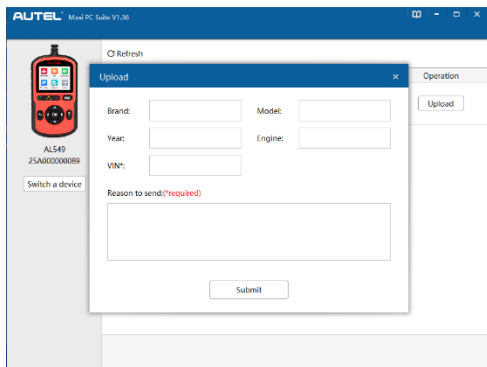

Figure 9-14 Upload Data Log Screen 2

- 6) The data log will be uploaded automatically. When uploaded successfully, the operation status reads “**Uploaded.**”
- When the data log is uploading, you can tap the **ESC** button on the AL549 to exit if you do not want to proceed.

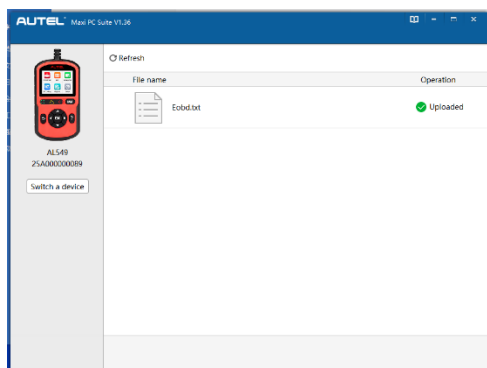

Figure 9-15 Upload Data Log Screen 3

About

The About function displays important tool information including serial number, password, and software version number.

- 1) From the Setup screen (Figure 9-2), use the **UP/DOWN** scroll button and **LEFT/RIGHT** scroll button to select **About**. Press the **OK** button and wait for the About screen to appear.
- 2) View tool information on the screen. Press the **ESC** button to exit.

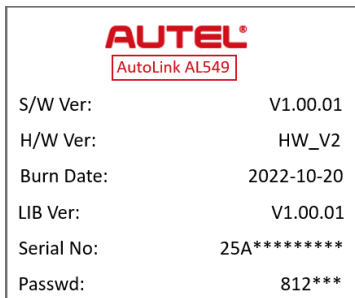

Figure 9-16 About Screen

10 Updates

This function enables the tool software to be updated through a Windows-based computer.

To update your scan tool, you need the following items.

- AutoLink® AL549
- A Windows-based computer or laptop with USB ports
- The provided USB cable

Register the Tool

The tool must be registered prior to updating. Register the tool on our website: <http://pro.autel.com>. Visit the site to download software update programs, research tools and retrieve warranty information.

NOTE

Prior to registration, please confirm your network is working properly.

1. Visit the website <http://pro.autel.com>.
2. If you have an Autel account, log in and skip to Step 7.
3. If you are a new member to Autel, click **Register** to create your Autel ID.
4. Enter your personal information. Fields marked with an asterisk (*) are mandatory.
5. After all the mandatory information is entered, read the **Autel User Service Agreement** and **Autel Privacy Policy**, then check the box to accept the terms and click **Register**.
6. Once your account is successfully registered, you will be redirected to the Product Registration screen. If not, click the button on the screen.
7. Your product serial number and password are required to enter. To find your serial number and password on the tool: go to **Settings** > **About**.
8. Enter your tool's serial number and password.
9. Enter the CAPTCHA code and click **Submit** to complete your product registration.

Update Procedure

Autel frequently releases software updates to download.

Connect the tool to a Windows-based computer using the included USB cable. Follow the update procedure to finish updating. The Windows version is taken as an example here.

1. Download the **Maxi PC Suite** from www.autel.com > *Support* > *Downloads* > *Autel Update Tools*, and install to your Windows-based computer.
2. Connect the scan tool to your computer with the provided USB cable.
3. Run the **Maxi PC Suite** on your computer. From the Main Screen in the tool, select **Setup** > **Update Mode**, and press **OK**. Wait for the Log In window to display.
4. Enter your Autel ID and password and wait for the Update window to appear. If you forgot your password, click **Forgot Password** to retrieve it. If you do not already have an Autel ID, you can click **Sign up** to create a new account.

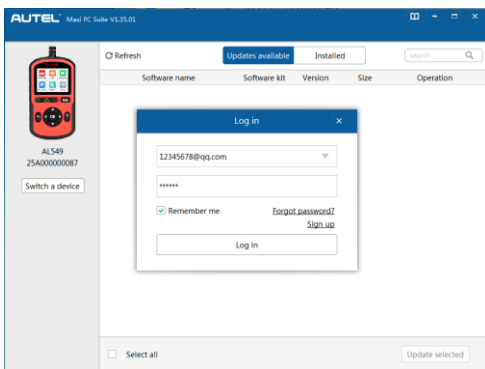

Figure 10-1 Log In Window

5. Select tool and serial number, click **OK** to continue.
6. In the **Update** window, locate the desired update and click the **Update** button.
7. The downloaded programs will automatically install. The update will replace the existing version of the software.

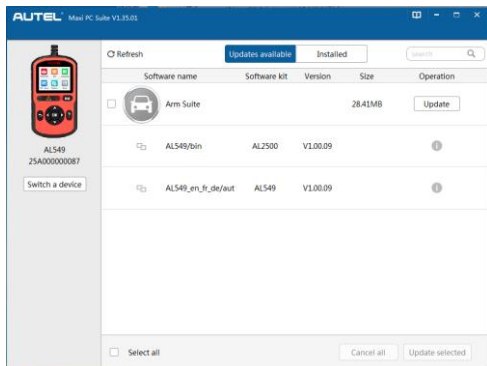

Figure 10-2 Update Window

- If you want to delete the installed programs, click on the **Installed** tag and then select the items you want to delete.

11 Compliance Information

FCC COMPLIANCE

FCC ID: WQ8-DR2015

This device complies with Part 15 of the FCC Rules. Operation is subject to the following two conditions:

- (1) This device may not cause harmful interference, and
- (2) This device must accept any interference received, including interference that may cause undesired operation.

WARNING

Changes or modifications not expressly approved by the party responsible for compliance could void the user's authority to operate the equipment.

NOTE

This equipment has been tested and found to comply with the limits for a Class B digital device, pursuant to Part 15 of the FCC Rules. These limits are designed to provide reasonable protection against harmful interference in a residential installation.

This equipment generates uses and can radiate radio frequency energy and, if not installed and used in accordance with the instructions, may cause harmful interference to radio communications. However, there is no guarantee that interference will not occur in a particular installation. If this equipment does cause harmful interference to radio or television reception, which can be determined by turning the equipment off and on, the user is encouraged to try to correct the interference by one or more of the following measures:

- Reorient or relocate the receiving antenna.
- Increase the separation between the equipment and receiver.
- Connect the equipment into an outlet on a circuit different from that to which the receiver is connected.
- Consult the dealer or an experienced radio/TV technician for help.

RF WARNING STATEMENT

The device has been evaluated to meet general RF exposure requirement.
The device can be used in portable exposure condition without restriction.

RoHS COMPLIANCE

This device is declared to be in compliance with the European RoHS Directive 2011/65/EU.

CE COMPLIANCE

Directive 2014/53/EU
On The Radio Equipment Directive

12 Warranty and Service

Limited One Year Warranty

Autel Intelligent Technology Corp., Ltd. (the Company) warrants to the original retail purchaser of this Autel device that should this product or any part thereof during normal usage and under normal conditions be proven defective in material or workmanship that results in product failure within 1 year period from the date of purchase, such defect(s) will be repaired, or replaced (with new or rebuilt parts) with Proof of Purchase, at the Company's option, without charge for parts or labor directly related to the defect(s).

 **NOTE**

If the warranty period is inconsistent with local laws and regulations, please comply with the relevant local laws and regulations.

The Company shall not be liable for any incidental or consequential damages arising from the use, misuse, or mounting of the device. Some states do not allow limitation on how long an implied warranty lasts, so the above limitations may not apply to you.

This warranty does not apply to:

- 1) Products subjected to abnormal use or conditions, accident, mishandling, neglect, unauthorized alteration, misuse, improper installation or repair or improper storage;
- 2) Products whose mechanical serial number or electronic serial number has been removed, altered or defaced;
- 3) Damage from exposure to excessive temperatures or extreme environmental conditions;
- 4) Damage resulting from connection to, or use of any accessory or other product not approved or authorized by the Company;
- 5) Defects in appearance, cosmetic, decorative or structural items such as framing and non-operative parts.
- 6) Products damaged from external causes such as fire, dirt, sand, battery leakage, blown fuse, theft or improper usage of any electrical source.

! IMPORTANT

All contents of the product may be deleted during the process of repair. You should create a back-up copy of any contents of your product before delivering the product for warranty service.

Service and Support

If you have any questions regarding the product, please contact one of our offices in your region.

Autel China Headquarters

- **Phone:** +86 (0755) 8614-7779 (Monday-Friday, 9AM-6PM Beijing Time)
- **Email:** support@autel.com
- **Address:** Floor 2, Caihong Keji Building, 36 Hi-tech North Six Road, Songpingshan Community, Xili Sub-district, Nanshan District, Shenzhen City, China
- **Web:** www.autel.com

Autel North America

- **Phone:** 1-855-288-3587 (Monday-Friday, 9AM-6PM Eastern Time)
- **Email:** ussupport@autel.com
- **Address:** 36 Harbor Park Drive, Port Washington, New York, USA 11050
- **Web:** www.autel.com/us

Autel Europe

- **Phone:** +49(0)89 540299608 (Monday-Friday, 9AM-6PM Berlin Time)
- **Email:** support.eu@autel.com
- **Address:** Landsberger Str. 408, 81241 München, Germany
- **Web:** www.autel.eu

Autel APAC

Japan:

- **Phone:** +81-045-548-6282
- **Email:** support.jp@autel.com

- **Address:** 6th Floor, Ari-nadoribiru 3-7-7, Shinyokohama, Kohoku-ku, Yokohama-shi, Kanagawa-ken, 222-0033 Japan
- **Web:** www.autel.com/jp

Australia:

- **Email:** ausupport@autel.com
- **Address:** Unit 5, 25 Veronica Street, Capalaba

Autel IMEA

- **Phone:** +971 585 002709 (in UAE)
- **Email:** imea-support@autel.com
- **Address:** 906-17, Preatoni Tower (Cluster L), Jumeirah Lakes Tower, DMCC, Dubai, UAE
- **Web:** www.autel.com
- **Autel Latin America**

Mexico:

- **Phone:** +52 33 1001 7880 (Spanish in Mexico)
- **Email:** latsupport@autel.com
- **Address:** Avenida Americas 1905, 6B, Colonia Aldrete, Guadalajara, Jalisco, Mexico

Brazil:

- **Email:** brsupport@autel.com
- **Address:** Avenida José de Souza Campos n° 900, sala 32 Nova Campinas Campinas – SP, Brazil
- **Web:** www.autel.com/br