



MAXISYS®

MaxiCheck®

MaxiIM®

MaxiTPMS®

MaxiBAS®

AutoLink®

MaxiVideo®

MAXISYS IA900

DIAGNOSTICS + WHEEL ALIGNMENT + ADAS CALIBRATION



MAXIMIZE *PROFITABILITY & EFFICIENCY*
WITH A SINGLE SYSTEM & WORKFLOW

At the Cost of a Typical Alignment System



At the cost of a typical alignment system, the Autel IA900 delivers an all systems and module health check, digital vehicle inspection, 3D wheel alignment, and step-by-step ADAS calibration instructions in a single system and investment.

The Autel IA900WA is the only system that starts and finishes through the OBD2 connector, beginning with a full health check and digital inspection. These integrated steps deliver the highest revenue potential, the most comprehensive repair, a safer alignment, and a complete calibration of all effected ADAS systems.

ALIGNMENT WITHOUT LIMITS

ACCESSORIES INCLUDED

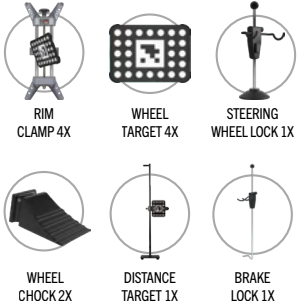

RIM
CLAMP 4X

WHEEL
TARGET 4X

STEERING
WHEEL LOCK 1X

WHEEL
CHOCK 2X

DISTANCE
TARGET 1X

BRAKE
LOCK 1X

AVAILABLE PACKAGES

IA900 PART# IA900WA
FRAME + ACCESSORIES

IA900 +TABLET PART# IA900WAT
FRAME + ACCESSORIES + ULTRA TABLET

IA900 LDW PART# IA900LDW
FRAME + ACCESSORIES + LDW TARGETS

IA900 LDW +TABLET PART# IA900LDWT
FRAME + ACCESSORIES + LDW TARGETS + ULTRA TABLET

IA900 ALL SYSTEMS PART# IA900AS
FRAME + ACCESSORIES + ALL SYSTEM TARGETS

IA900 ALL SYSTEMS +TABLET PART# IA900AST
FRAME + ACCESSORIES + ALL SYSTEM TARGETS + ULTRA TABLET

IA900 SYSTEM



IDEAL
FOR:



GENERAL
REPAIR

COLLISION
REPAIR

TIRE
DEALERS

CALIBRATION
CENTERS

AUTOMOTIVE
DEALERSHIPS



ADAS ACCESSORIES

SOLD SEPARATELY

500-17 TIRE CLAMPS (SET OF 4)

In contrast to standard clamps, tire clamps attach to tires rather than to rims, eliminating potential rim damage.



500-20 RIDE HEIGHT TARGETS (SET OF 4)

Enables rapid vehicle suspension height measurement and eliminates the need for manual measurement and entry.



500-21 WIDE ANGLE TARGETS

Attach to front camera targets to ensure camera view and complete readings during max angle caster sweep.

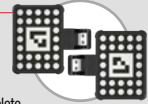

ADAS ACCESSORY KIT

Kit includes an L-Shaped Bracket, Five Line Laser, Laser Reflector, Laser Assist Mirror, Two Line Laser, and Plumb Bob to assist with faster blind spot placement and set-up time.

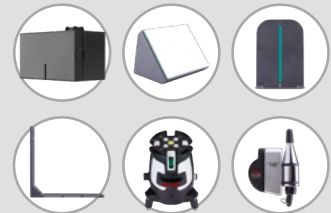

GENERATE \$537K A YEAR IN ADDITIONAL ADAS SAFETY CALIBRATIONS

*SEE THE FULL PICTURE AT OUR WEBSITE ▶

AVAILABLE PACKAGES

IA800 LDW PART# LDW30
FRAME + ACCESSORIES + LDW TARGETS

IA800 LDW +TABLET PART# LDW30T
FRAME + ACCESSORIES + LDW TARGETS + MS909 TABLET

IA800 ALL SYSTEMS PART# AS30
FRAME + ACCESSORIES + ALL SYSTEM TARGETS

IA800 ALL SYSTEMS +TABLET PART# AS30T
FRAME + ACCESSORIES + ALL SYSTEM TARGETS + MS909 TABLET

IA800 SYSTEM

IDEAL
FOR:



GENERAL
REPAIR



COLLISION
REPAIR



GLASS
REPAIR

HD CAMERA
SYSTEM



RIM CLAMP 4X



WHEEL TARGET 4X



BRAKE LOCK 1X

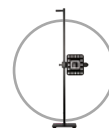

DISTANCE TARGET 1X

LEARN ABOUT ADAS
SHOP REQUIREMENTS



SCAN
HERE

ADAS ACCESSORIES PACKAGE

PART # ADASACCESSORY



TWO LINE
LASER 1X



LASER REFLECTIVE
BOARD 1X



FIVE LINE
LASER 1X



L BRACKET 1X

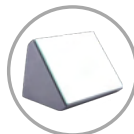

LASER ASSISTED
REFLECTOR 1X



PLUMB LINE 1X



TRAVEL CASE 1X

MAXISYS MA600

MOBILE ADAS CALIBRATION SYSTEM

The Autel MA600 portable ADAS calibration system is ideal for multi-location shops and mobile calibration businesses. The compact frame folds and disassembles to easily fit into the trunk of a car or service vehicle for easy transportation.



Removable base and foldable arms allow for easy transport

CARRYING CASES

SOLD SEPARATELY P/N: MAG00CASE



PORTABLE ADAS

MA600 SYSTEM

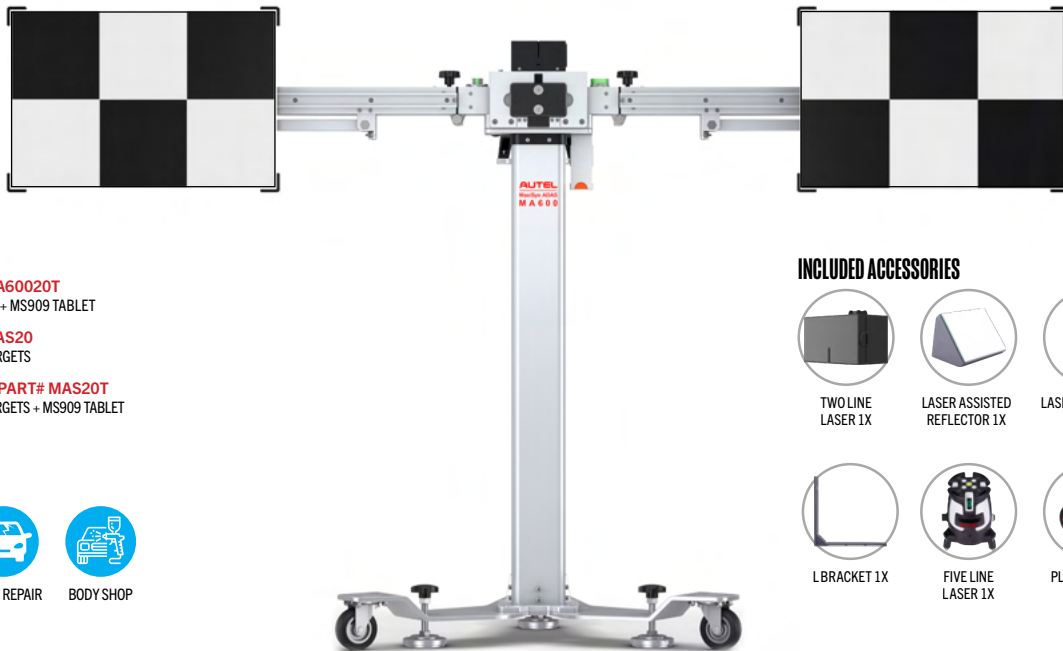

AVAILABLE PACKAGES

MA600 LDW PART# MA60020
FRAME + ACCESSORIES + LDW TARGETS

MA600 LDW +TABLET PART# MA60020T
FRAME + ACCESSORIES + LDW TARGETS + MS909 TABLET

MA600 ALL SYSTEMS PART# MAS20
FRAME + ACCESSORIES + ALL SYSTEM TARGETS

MA600 ALL SYSTEMS +TABLET PART# MAS20T
FRAME + ACCESSORIES + ALL SYSTEM TARGETS + MS909 TABLET

IDEAL FOR:



COMPACT



MOBILE



GLASS REPAIR



BODY SHOP

INCLUDED ACCESSORIES



TWO LINE
LASER 1X

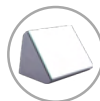

LASER ASSISTED
REFLECTOR 1X

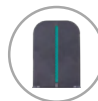

LASER REFLECTIVE
BOARD 1X



L BRACKET 1X



FIVE LINE
LASER 1X



PLUMB LINE 1X



MOUNTING PLATE 1X
*AVAILABLE WITH ALL
SYSTEM PACKAGES ONLY.

AUTEL LIFTS

12,000 LBS & 14,000 LBS CAPACITY

BRING YOUR BAY TO THE **MAX**

SPECIALLY DESIGNED TO GIVE MORE USABLE FLOOR SPACE
& PERFORM ADAS CALIBRATIONS WITHIN THE SAME BAY*



AULS12ALOR1T
AULS14ALOR1T
AULS12ALOR1
AULS14ALOR1



*The space required for some ADAS calibrations may exceed that of a typical shop bay. Visit autel.cc/adas-shop/ to maximize your service bays.

ADAS & ALIGNMENT LIFTS

FEATURES

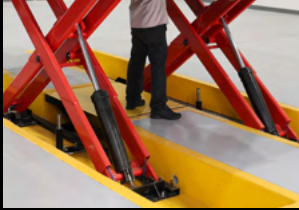

- Flush-mounted Hydraulic Alignment Scissor Lift (Bay Max Lifts only)
- Floor Table Riser (Bay Max Lifts only)
- Stainless Steel Front Radius Plates and Rear Slip Plates
- Front and Rear-opening Runways with Flip Down Wheel Stops (Bay Max Lifts only)
- Made in North America and ALI Certified
- Built-in Runway Air Tire Inflation Kit at each wheel and Shatterproof LED Light Kits
- Enclosed Console Control Power Unit
- Premium Double Baked Powder Coating Finish and Industrial-grade Rust Proofing

ADAS BAY MAX LIFT



P/N: AULS12ALOR1T / ADAS BAY MAX 12K LIFT

12,000-pound capacity

Includes two 6K capacity Jacking Beams

185"-LONG, 26"-WIDE SPACE SAVING RUNWAYS

P/N: AULS14ALOR1T / ADAS BAY MAX 14K LIFT

14,000-pound capacity

Includes two 7K capacity Jacking Beams

203"-LONG, 26"-WIDE SPACE SAVING RUNWAYS

ALIGNMENT SCISSOR LIFT



P/N: AULS12ALOR1 / ALIGNMENT 12K SCISSOR LIFT

12,000-pound capacity

Includes two 6K capacity Jacking Beams

185"-LONG, 23"-WIDE SPACE SAVING RUNWAYS

P/N: AULS14ALOR1 / ALIGNMENT 14K SCISSOR LIFT

14,000-pound capacity

Includes two 7K capacity Jacking Beam

203"-LONG, 23"-WIDE SPACE SAVING RUNWAYS

VIEW THIS
ON OUR
WEBSITE



MAXISYS

ADVANCED DIAGNOSTICS FOR EV, HYBRID, GAS & DIESEL VEHICLES

THE POWER OF EVOLUTION

- DETAILED BATTERY PACK DIAGNOSTICS
- STATE OF CHARGE & STATE OF HEALTH ANALYSIS
- SPECIALIZED BATTERY ANALYSIS VIA BMS
- DETAILED CABLE CONNECTION DIAGRAMS



REGISTER FOR TRAINING COURSES

[AUTEL.COM/US/ACADEMY-TRAINING/](https://www.autel.com/us/academy-training/)

EV DIAGNOSTICS & ANALYSIS

FEATURES



EVDIAG BOX

DIAGNOSTIC SUPPORT OF HIGH-VOLTAGE SYSTEMS

COMPREHENSIVE

Advanced diagnostics for U.S., European and Asian electric, gas and diesel, and hybrid vehicles.

EFFICIENT

Rapid analysis of EV high-voltage system including ability to read and erase codes and view live data.

DEPENDABLE

Comprehensive diagrams of high-voltage system block, components and sockets, step-by-step system disassembly instructions.

VIEW THIS
ON OUR
WEBSITE



ULTRA EV



13-INCH SCREEN

EVDIAG BOX

Secure High-Voltage Testing

Battery Pack Diagnostics

Topology: Module Mapping*

Remote Expert Access

OSCILLOSCOPE FUNCTIONALITY

MAXIFLASH VCI 5-IN-1 DEVICE



MS909EV



10-INCH SCREEN

EVDIAG BOX

Secure High-Voltage Testing

Battery Pack Diagnostics

Topology: Module Mapping*

Remote Expert Access

36 Service Features / Bi-Directional

MAXISYS-VCI: NEW PROTOCOLS



EVDIAGKIT



UPGRADE YOUR MAXISYS TO INCLUDE EV DIAGNOSTICS

COMPATIBLE TABLETS

MaxiSYS Ultra
MaxiSYS Ultra ADAS
MaxiSYS MS919
MaxiSYS MS909

KIT INCLUDES

EVDiag Box & Adapters for Specific Electric Vehicles to Perform Battery Pack Analysis. Connects to MaxiFlash VCI or VCI1,

*Topology Module Mapping available on select vehicles

All current MaxiSYS tablet models contain the following features on supported vehicles: Auto-VIN / Auto-SCAN DTC Detection, Access All Modules in All Systems, Access Repair Records & Test Data, Advanced Service Features, Coding & Adaptations, DPF Regeneration, Covers Domestic, Asian & European Manufacturers (1996 - Present), Generate & Print Diagnostic Reports, Reset Diesel Emissions Light / Med. Duty, Wireless Software Updates

MAXISYS

ADVANCED ANALYSIS DIAGNOSTICS SYSTEM

MOTOR

TRUSPEED REPAIR

NOW AVAILABLE ON
ULTRA-SERIES TABLETS



SCAN FOR
DETAILS



REGISTER FOR TRAINING COURSES
AUTEL.COM/US/ACADEMY-TRAINING/

ADVANCED DIAGNOSTICS

FEATURES

TOPOLOGY

SPLIT SCREEN

CODING & ADAPTATIONS

4-CHANNEL OSCILLOSCOPE

DOIP / CAN FD PROTOCOLS
FOR NEW HIGH SPEED
CAN-EQUIPPED VEHICLES

POWERFUL HARDWARE

- OCTA-CORE PROCESSOR / 256GB MEMORY
- LARGER 13" HEAVY DUTY TOUCHSCREEN
- FASTER DUAL WI-FI CONNECTION
- NEW ANDROID 7.0 OS MULTI OPERATION
- MAXIFLASH VCM1 INCLUDED WITH MSULTRA, MS919

VIEW THIS
ON OUR
WEBSITE



MSULTRA



DOCKING STATION- MAINTAINS BATTERY CHARGE WHEN NOT IN USE
13-Inch Screen

SPLIT SCREEN DISPLAY

Topology: Module Mapping*

Remote Expert Access

SCANVIN / AUTO-VIN / AUTO-SCAN

MAXIFLASH VCM1 5-IN-1 DEVICE

Battery & ADAS Software Upgrades Available



OSCILLOSCOPE CABLES INCLUDED

1-YR FREE SOFTWARE

TOTAL CARE PROGRAM (TCP) \$1,695**
ADDITIONAL 1 YEAR COVERAGE



MS919



10-INCH SCREEN

Topology: Module Mapping*

Remote Expert Access

SCANVIN / AUTO-VIN / AUTO-SCAN

Battery & ADAS Software Upgrades Available

36 Service Features / Bi-Directional

MAXIFLASH VCM1 5-IN-1 DEVICE

OBDII CONNECTOR KIT INCLUDED

1-YR FREE SOFTWARE

TOTAL CARE PROGRAM (TCP) \$1,495**
ADDITIONAL 1 YEAR COVERAGE



MS909



10-INCH SCREEN

Topology: Module Mapping*

Remote Expert Access

SCANVIN / AUTO-VIN / AUTO-SCAN

Battery & ADAS Software Upgrades Available

36 Service Features / Bi-Directional

MAXISYS-VCI: NEW PROTOCOLS

OBDII CONNECTOR KIT INCLUDED

1-YR FREE SOFTWARE

TOTAL CARE PROGRAM (TCP) \$1,295**
ADDITIONAL 1 YEAR COVERAGE



*Topology Module Mapping available on select vehicles

All current MaxiSYS tablet models contain the following features on supported vehicles: Auto-VIN / Auto-SCAN DTC Detection, Access All Modules in All Systems, Access Repair Records & Test Data, Advanced Service Features, Coding & Adaptations, DPF Regeneration, Covers Domestic, Asian & European Manufacturers (1996 - Present), Generate & Print Diagnostic Reports, Reset Diesel Emissions Light / Med. Duty, Wireless Software Updates

REMOTE EXPERT

REMOTELY CONNECT WITH AN EXPERT TO COMPLETE YOUR PROGRAMMING NEEDS
Developed by Autel, Remote Expert is a cloud-based solution offering technicians with module programming requirements a connection to pre-qualified Remote Experts in the field. Offered through MSUltra, MSUltra EV, MS919, MS909, MS909 EV, or XLink, technicians now have the ability to connect with experts ready to complete their programming needs.

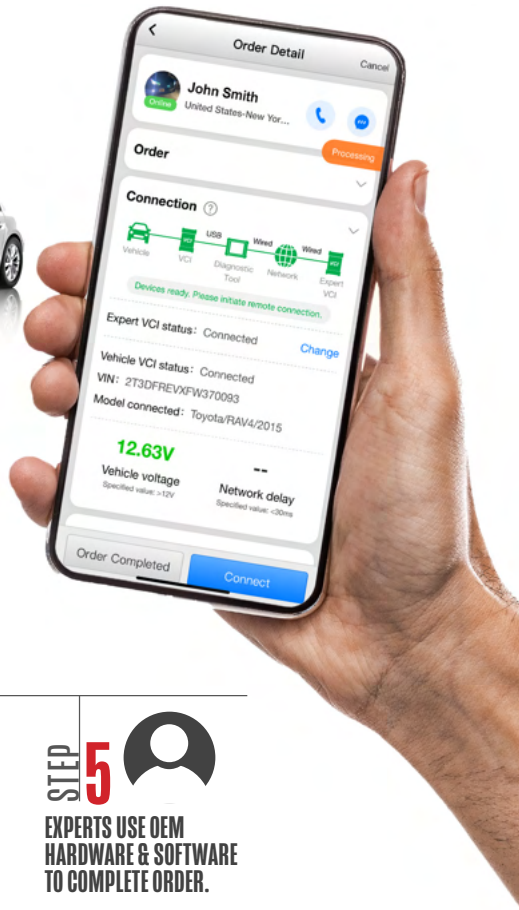

WATCH VIDEO NOW

STEP 1 
CONNECT VCI/VCMI OR XLINK TO THE VEHICLE WITH OBDII CABLE.

STEP 2 
ENSURE TABLET OR XLINK IS CONNECTED TO THE INTERNET ROUTER AND TABLET IS CONNECTED TO VCI/VCMI.

STEP 3 
IF USING TABLET (ULTRA EV, MS909 EV, ULTRA, MS919 OR MS909) ENSURE IT IS CONNECTED TO VCI/VCMI.

STEP 4 
POST YOUR ORDER VIA TABLET OR MAXIFIX APP. MAXIFIX APP IS COMPATIBLE WITH IOS & ANDROID.

STEP 5 
EXPERTS USE OEM HARDWARE & SOFTWARE TO COMPLETE ORDER.

REMOTE OEM SOLUTIONS

ASTECH SERVICES AVAILABLE NOW



**CERTIFIED MASTER
TECHNICIANS**



**ACCESS TO
OEM TOOLS**



**MODULE
PROGRAMMING**



**ADAS OEM
SPECIFICATIONS**



**AVAILABLE ON
AUTEL SCAN TOOLS**

MSULTRA / MSULTRA EV / MS919
MS909 / MS909 EV / XLINK

**COLLISION
READY
VERIFIED
OEM SCANS**



With an Autel MaxiSYS Ultra Series tablet or the MaxiFlash XLink device, technicians can access the Remote Expert platform and asTech Remote OEM Solutions. Connect to the platform's more than 50 independent, experienced programmers and diagnosticians with OEM subscriptions and tools. Or use asTech's team of ASE and I-CAR-certified technicians to perform OEM scans and programming, identify ADAS calibration requirements, and receive detailed insurance-ready reports.

MAXIFLASH

TOUCHSCREEN PASS-THRU DEVICE WITH DIRECT ACCESS TO REMOTE EXPERT SERVICES



AUTEL
REMOTE
EXPERT

REMOTE PROGRAMMING
READY DEVICE



3-IN-1 COMMUNICATION & PROGRAMMING

FEATURES



Technicians post orders to the Remote Expert platform via the Autel MaxiFix mobile app

DUAL CHANNELS FOR DATA TRANSFER EFFICIENCY



Server and point-to-point
Dual Channel Communication



Hard-wired and Wi-Fi network
communication modes



Update software via
Internet connection

VIEW THIS
ON OUR
WEBSITE



XLINK

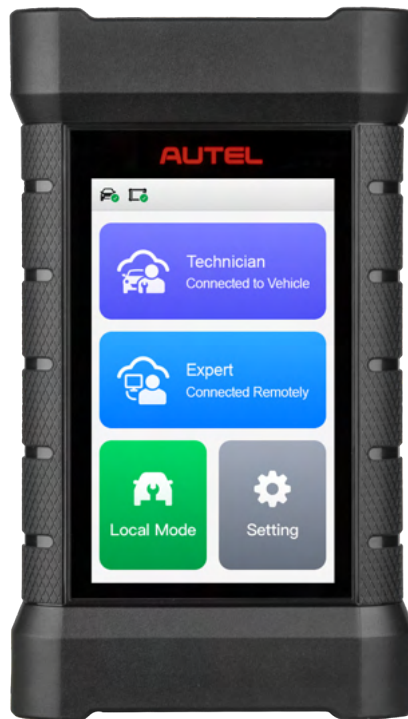

4-INCH SCREEN

REMOTE EXPERT READY DEVICE

Connect with module programmers,
automotive diagnosticians, and system experts
for tasks requiring OE data, software, or tools.

J2534 PASS-THRU PROGRAMMER

Perform Module Programming with
a Windows PC & OE Subscriptions

ENHANCED, MULTI PROTOCOL VCI

Pair with any Autel MaxiSYS Tablet to
Perform Advanced Diagnostics with
Multiple Communication Protocols
Including CAN, CAN FD & DoIP



4.0 in
High Resolution
Color Display

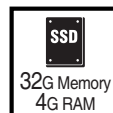

SSD
32G Memory
4G RAM

WATCH THE VIDEO



SCAN
HERE

MAXISYS

AUTEL'S LATEST DIAGNOSTIC TABLETS

**ADVANCED DIAGNOSTICS
PLUS CODING
& ADAPTATIONS**

**ALL-SYSTEMS AUTO SCAN
WITH ADAS IDENTIFICATION**

**SUPPORTS THE LATEST
DIAGNOSTIC PROTOCOLS**



NEXT GENERATION PRO

FEATURES



Technicians post orders to the Remote Expert platform via the Autel MaxiFix mobile app

CLOUD SERVICES

- PRE/POST-SCAN REPORTS
- CUSTOMER VEHICLE DATA
- REPORT STORAGE & FILE SHARING



MS906PRO-TS

COMPLETE TPMS

VIEW THIS
ON OUR
WEBSITE



MS906PRO



8-INCH TOUCHSCREEN

ScanVIN / License Plate reader

Bi-Directional Control

16MP & 5MP Front Camera

FCA Secure Gateway Access

ADAS & Battery Function Capability

New Cloud Services



8 in
1920x1200
LED Touchscreen



23GHz + 17GHz
Hexa-Core



7.0
Android OS



VCI 200

OBDDII CONNECTOR KIT INCLUDED

1-YR FREE SOFTWARE



MS906PRO-TS



8-INCH TOUCHSCREEN

Complete TPMS Functionality

Bi-Directional Control

1-Sensor Programming

FCA Secure Gateway Access

ADAS & Battery Function Capability

Wi-Fi Printing



8 in
1920x1200
LED Touchscreen



23GHz + 17GHz
Hexa-Core



7.0
Android OS



VCI 200

OBDDII CONNECTOR KIT INCLUDED

1-YR FREE SOFTWARE



All current MaxiSYS tablet models contain the following features on supported vehicles: Auto-VIN / Auto-SCAN DTC Detection, Access All Modules in All Systems, Access Repair Records & Test Data, Advanced Service Features, Coding & Adaptations, DPF Regeneration, Covers Domestic, Asian & European Manufacturers (1996 - Present), Generate & Print Diagnostic Reports, Reset Diesel Emissions Light / Med. Duty, Wireless Software Updates

MAXICHECK

EXTRAORDINARY DIAGNOSTICS

- Extensive vehicle coverage for U.S., Asian, and European vehicle makes
- Read/Erse Codes, View/Graph Live Data
- Performs Active Tests and Special Functions
- Smart AutoVIN technology for identifying vehicles easily
- Supports DoIP and CAN FD protocols
- Performs Pre & Post Scan
- Supports all OBDII protocols and 10 test modes

ADVANCED SERVICE FUNCTIONS

- Forced Diesel Particulate Filter (DPF) regeneration
- Steering Angle Sensor (SAS) reset
- Oil Light Service and battery registration
- Resets service mileage and service intervals
- EPB reset and Preform Brake Bleed
- EPB reset and Preform Brake Bleed

MX900



1-YR FREE SOFTWARE

8-INCH SCREEN



1280x800
Touchscreen



1.8GHz
Quad-Core

Android 11 Operating System

40+ Service Functions

Access All Modules in All Systems

Active Tests & Special Functions

Supports DoIP & CAN FD Protocols

Includes OBDII Cable



Android OS



OBDII Cable

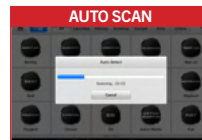
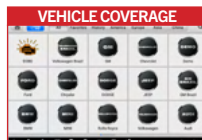

FEATURES



ALL SYSTEMS DIAGNOSTICS

- Read/ Test/ Clear trouble codes in ALL Systems: ABS, SRS, ENGINE, TRANSMISSION+
- Auto VIN for Quick DTC Definitions
- Live Data to test individual systems
- Communicate with door modules, body controllers, electronic modules
- Support all OBDII protocols and 10 test modes including Freeze Frame, Enhanced Mode 6, Vehicle Info, I/M Readiness, On-Board Monitor and Component Tests
- Graph, record and playback freeze frame data



AFFORDABLE SERVICE 7 FUNCTIONS

- Read and clear trouble codes, control and test BMS / EPB / SAS/ Oil Light Reset I DPF systems
- Diesel particulate/ including forced regeneration
- Reset steering angle sensor (SAS functionality)
- Reset oil service and battery registration
- Resets Battery Monitoring System
- Reset service mileage and service intervals
- Perform OLS / oil service resets
- Set inspection 1 & 2 service intervals
- Opens and closes EPB (electronic brake calipers) for pad removal and service
- Read and clear EPB/SBC trouble codes
- Diagnose EPB/SBC (Sensotronic Brake Control) caliper functionality with bi-directional control
- Perform O2 monitor, on-board monitor, I/M readiness and component testing

LIVE ENGINE DATA

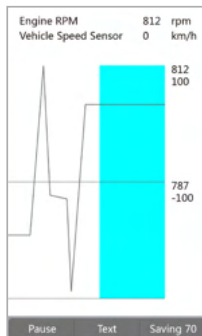

AUTO SCAN

100%	Auto Scan	
1	ABS--Anti-Lock Brakes / Traction Control Module	Fail 1
2	EPS--Electronic- Controlled Power Steering	Pass No Fault
3	PCM--Powertrain	Pass No
4	TCM--Transmission Control Module	Pass No Fault

Quick Erase Save Display DTC

MD808P



4-INCH SCREEN

7 Service Functions Set Inspection Service Intervals
 AutoSCAN DTCs Detection I/M Readiness /Emissions Testing
 Access All Modules in All Systems Includes OBDII Cable



DPF SERVICE

Regeneration of diesel particulate filter w	
Engine speed	4 l/min
Current injection quantity	0.39 mg/hub
Air mass	0.00 mg/hub
Coolant temperature	288 °F
Total distance at last correction of ash	0 miles

OK

BATTERY RESET

Power supply(Battery)	
1	Battery
2	Close-circuit current
3	Activate rest state
4	Charging the battery via diagnostic socket
5	Auxiliary battery (24 V EPS): Register battery replacement

AP2500



APP-BASED DIAGNOSTICS COMPATIBLE WITH ANDROID & IOS PHONES

SUPPORTS COMMONLY PERFORMED SERVICE FUNCTIONS

- Oil light reset, TPMS release, battery registration, and wiper replacement
- Features "Find a Local Repair Shop" function for quick maintenance and service needs
- Test hybrid & electric vehicle power battery. Assess battery State of Charge (SoC), State of Health (SoH), and recharge mileage
- Provides DTC query/TSBs/definitions of common dashboard lights/100-km dynamic acceleration test
- Vehicle health check including engine oil life, average fuel consumption, and brake pad life

TOTAL CARE PROGRAM

DON'T MISS OUT ON VALUABLE BENEFITS & TOOL FUNCTIONALITY.



EXTEND TOOL WARRANTY

Eliminate Downtime and Reduce Functionality

LATEST VEHICLE COVERAGE

Service All the Latest Makes and Models Supported By Autel

THE WARRANTY & FREE SOFTWARE UPDATES INCLUDED WITH TOOL PURCHASE EXPIRE 1 YEAR AFTER TOOL REGISTRATION. APPLICABLE TO MOST AUTEL TABLETS.

TOOL FUNCTION

Get the Latest Technology from Autel



VIEW DETAILS
ONLINE

ACTIVE SUBSCRIPTION NOW NEEDED
FOR VEHICLE BRANDS REQUIRING
SERVER ACCESS

4 WAYS TO ENROLL:

Updating your tool coverage with a full year TCP subscription is fast and easy. Choose one of four easy ways to renew your coverage and your Autel tool will be up and running with unlimited access to the latest software and functionality.

YOUR AUTHORIZED AUTEL DEALER OR RETAILER

Pick up a card and enter
the number from the back.

DIRECTLY FROM YOUR TABLET

Renew quickly,
right on the tool.

YOUR AUTEL.COM ACCOUNT

Visit pro.autel.com and sign in with your
Autel ID. Click the "Expired Software" link
to identify which of your tools needs a
software update.

AN AUTEL CUSTOMER SUPPORT SPECIALIST

Our friendly support staff are happy to
guide you through the update process.

UPDATE DIRECTLY FROM YOUR TABLET

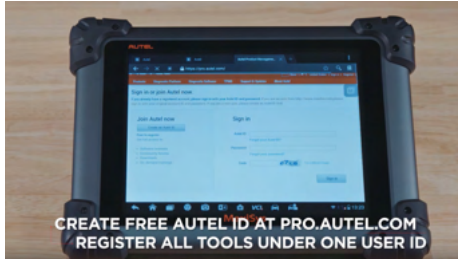

1. REGISTER YOUR MAXISYS AT PRO.AUTEL.COM & PURCHASE TCP



2. USE ACTIVATION CODE ON CARD OR DIGITAL CODE PROVIDED IN EMAIL

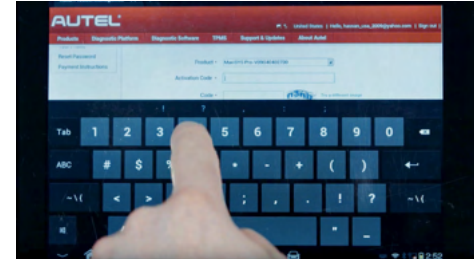

3. REDEEM CODE TO ACTIVATE SUBSCRIPTION & WARRANTY

UPDATE FROM YOUR AUTEL.COM ACCOUNT



PRODUCT REGISTRATION
REGISTER VIA PC OR DIRECTLY FROM TABLET

1. Create a FREE Autel User ID at pro.auteltech.com
2. Go to Product Registration
3. Select tool from the Drop Down Menu
4. Enter Serial Number and Password found on tool under Settings, then About
5. Enter the Capcha Code then Submit

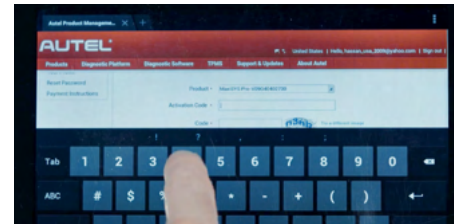

REDEEM TCP SUBSCRIPTION
REDEEM VIA PC OR DIRECTLY FROM TOOL

1. Log in at pro.auteltech.com
2. Go to Account, then select Redeem
3. Enter TCP Code to Activate Extended Coverage

MAXISYS CV

COMMERCIAL VEHICLE DIAGNOSTICS

ALL MAKES / ALL MODELS

Class 1 (0-6,000lbs) - Class 9 (33,000lbs)

VEHICLE COVERAGE

- Light duty pickup
- Medium duty trucks
- Heavy duty trucks
- School buses
- Transit buses
- Recreational vehicles
- Emergency vehicles

CONNECTORS

DEUTSCH 9-PIN / DEUTSCH 6-PIN



HEAVY DUTY DIAGNOSTICS

FEATURES

OFF-HIGHWAY COVERAGE ON THE MS909CV

Diagnostics for Construction
and Agricultural Machinery

SUPPORTS CATERPILLAR, CUMMINS,
AND HINO ENGINES.

Supports 60+ brands including
CATERPILLAR, JOHN DEERE,
HITACHI, KOBELCO, LIEBHERR,
CLAAS, and more.



**MANUFACTURER-SPECIFIC
ADAPTERS AVAILABLE**

P/N# CAT14, CAT9, KOMATSU12,
CUMMINS8, BENZ14

VIEW THIS
ON OUR
WEBSITE



MS909CV



MAXIFLASH VCI
LATEST PROTOCOLS

9.7-INCH TOUCHSCREEN

MAXIBAS B200
BATTERY ANALYSIS

Lightening Fast Auto-Scan

Works with Emergency Vehicles, Buses

Topology: Module Mapping*

Customizable Parameter Changes

Covers Over 80 Makes & Models

Dynamic ADAS Calibration (Class 6-8)



1536x2048
LED Touchscreen



7.0
Android OS



2.2GHz-1.8GHz
Octa-Core



J2534
MaxiFlash VCI

VCI, B200, CURRENT CLAMP
& MULTIMETER INCLUDED

1-YR FREE SOFTWARE



*Topology Module Mapping available on select vehicles. Internet access required.

MS908CVII



9.7-INCH TOUCHSCREEN

MAXIFLASH ELITE*

Bi-Directional Active Tests

DPF & SCR Regeneration

Customizable Parameter Changes

Perform Injector Cutout Tests

Aftertreatment Testing And Resets

Injector Coding/Programming



1536x2048
LED Touchscreen



10.0
Android OS



2.2GHz-1.8GHz
Octa-Core



128GB
Memory

OBDDII CONNECTOR KIT INCLUDED

1-YR FREE SOFTWARE

**GET MFVCI KIT FREE
WITH PURCHASE**
SCAN FOR DETAILS



*Additional purchase of the VCI200 is required to access
the latest protocols for light duty vehicles 2018 and newer

MAXIIM

PROFESSIONAL TOOL SOLUTIONS FOR AUTO KEYS

FEATURES

**2 PROGRAMMABLE
IKEYS INCLUDED**

**60-SECOND
KEY GENERATION**

**GUIDED IMMO
USER INSTRUCTIONS**

Autel key programming and IMMO products are designed for professional locksmiths and NASTF-registered Vehicle Security Professionals. Please ensure you meet local licensing requirements before purchasing.



ADVANCED KEY FUNCTIONS

- Universal Transponder
- Key Generator
- Transponder Simulation, Editing & Cloning
- Ignition Coil Detection



2 UNIVERSAL IKEYS INCLUDED WITH KM100

- 100% Vehicle Coverage
- Replacement for more than 3,000+ Vehicles
- 315MHz & 434MHz Frequencies

ADVANCED KEY IMMOBILIZER

VIEW THIS
ON OUR
WEBSITE



WI-FI SOFTWARE UPDATES



DOWNLOAD
FREE
SOFTWARE
ONE YEAR LIMITED WARRANTY

KM100

KEY READING

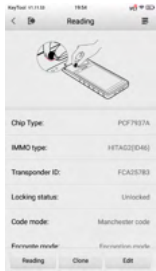

COIL DETECTION

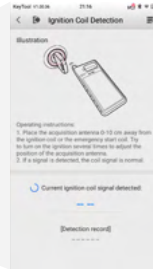

KEY GENERATION

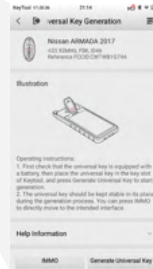

Key Generator

OE-Level Vehicle Coverage

Advanced Service Functions

Ignition Coil Detection

Transponder Reading

Key Unlocking / Key Renewal

IKEY

TOYOTA-STYLE
IKEYS NOW
AVAILABLE



PREMIUM STANDARD RAZOR

UNIVERSAL & PROGRAMMABLE
IKEYS ALSO SOLD SEPARATELY

2-7 BUTTON
CONFIGURATIONS

130FT FREQUENCY
TRANSMISSIONS

3,000+ VEHICLE KEY
REPLACEMENT
WORLDWIDE

OE-QUALITY DESIGNED TO MEET OR
EXCEED INDUSTRY STANDARDS

MAXIIM

ADVANCED IMMO & KEY PROGRAMMING BUNDLE

**PROGRAMS
MAXIIM IKEYS**

SOLD SEPARATELY

**EXPANDED
EEPROM FUNCTION**

INCLUDING 2000 COMPONENT TYPES



ADVANCED KEY PROGRAMMING BUNDLE

FEATURES

ITEMS INCLUDED WITH IM608PROIIKPA BUNDLE

- IM608PROII 10.1" Touchscreen Android Tablet
- XP400 PRO: Key & Chip Programmer
- MaxiFlash JVC1
- IMKPA: Key Programmer Adapter Kit



DIAGNOSTICS & SERVICE

- Powerful OE-Level Diagnostics For U.S., Asian, European Makes and Models
- Advanced Maintenance Services: EPB, DPF, SAS, Oil reset, BMS
- Advanced Diagnostics Tablet Featuring AutoVIN All System AutoSCAN
- Perform Active Tests, Coding And Adaptations



XP400PRO & IMKPA INCLUDED WITH BUNDLE

- Read/Write/Erase Mercedes-Benz ESL_W209/W906 Data
- Mercedes-Benz OE NEC Key Learning
- BMW EWS3 Key Learning
- Volkswagen/Audi/BMW/Mercedes-Benz Key Unlock

VIEW
ON OUR
WEBSITE



IM608PROIIKPA

IMKPA

Expanded Key Programming Accessories

ALSO SOLD SEPARATELY
COMPATIBLE WITH XP400PRO



XP400PRO

Advanced All-in-One Key Programmer

ALSO SOLD SEPARATELY

Autel key Mercedes programming and IMMO products are designed for professional locksmiths and NASTF-registered Vehicle Security Professionals. Please ensure you meet local licensing requirements before purchasing.



ADVANCED IMMO & KEY PROGRAMMING

- Key Learning via OBDII Port for 85% of North American Vehicles
- Read Immobilizer Pins & Password Directly From Vehicle
- Store Vehicle Information To Use When Learning New Keys
- Smart Mode For Guided and Automated Key Learning
- Read Pin/Cs (All Keys Lost), Key Generation, Key Learning, Remote Learning
- IMMO ECU reset/Adaptation, refresh/Coding
- Transponder read/Write, EEPROM/MCU read/Write
- Expert Mode For Advanced Key Learning

EXPANDED EUROPEAN VEHICLE COVERAGE Mercedes-Benz, BMW, Volkswagen/Audi, Mazda, Renault, LandRover/Jaguar, Volvo

MAXIIM

ALL-IN-ONE KEY PROGRAMMING & DIAGNOSTICS

PROGRAMS
MAXIIM IKEYS

SOLD SEPARATELY



Autel key programming and IMMO products are designed for professional locksmiths and NASTF-registered Vehicle Security Professionals. Please ensure you meet local licensing requirements before purchasing.

BASIC KEY PROGRAMMING

FEATURES



DIAGNOSTICS & SERVICE

- Powerful Combination Of Key Programming, All System Diagnostics, and Advanced Maintenance Services
- Powerful Diagnostics For U.S., Asian and European Vehicles, 1996 & Newer
- Advanced Maintenance Services including EPB, DPF, SAS, Oil reset, BMS



BASIC IMMO & KEY PROGRAMMING

- Smart Mode For Guided and Automated Key Learning
- Expert Mode For Advanced Key Learning
- Backup, Restore, Adaptations/Coding, Key Generation, Key Learning, Remote Learning
- Read PIN/CS (All Keys Lost), Key Generation, Key Learning, Remote Learning, IMMO ECU Reset/Adaptation, Refresh/Coding



XP200 KEY & CHIP PROGRAMMER

- Key Read / Write
- EEPROM / MCU Read / Write

VIEW
ON OUR
WEBSITE



WI-FI SOFTWARE UPDATES



1-YR FREE SOFTWARE

TOTAL CARE PROGRAM (TCP) \$349⁵⁰
ADDITIONAL 1 YEAR COVERAGE



5,000 mAh
Lithium-polymer



1.7 GHz
Hexa-Core

IM508S



7-INCH SCREEN

U.S. and Asian Vehicle Coverage

All System Diagnostics

Advanced Service Functions

IMMO & Key Programming

Smart & Expert Modes

Use to Program IKEYs (sold separately)



4.4.2
Android OS



2G Memory



SERVICE FUNCTION



KEY PROGRAMMING

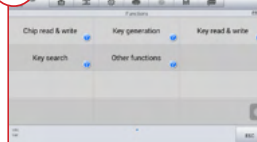

AUTO-VIN



XP400 PRO



ADD EUROPEAN
VEHICLE COVERAGE
TO YOUR IM508
OR IM608 PRO WITH
THE XP400 PRO

ADVANCED ALL-IN-ONE KEY PROGRAMMER



- Expanded EEPROM functions for more component access
- 170+ types Odometer component reading functions
- 180+ Immobilizer ECU component types
- 40+ Engine ECU component types
- 2000+ MCU component types
- 440+ EEPROM component types
- Compatible with IM508, IM508S, IM608PRO, IM608PROII
- Includes 1-Year Warranty
- Free Software Updates for Life of Tool

IMKPA

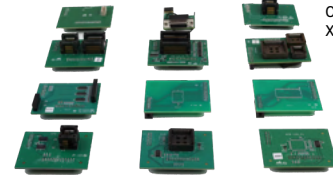

COMPATIBLE WITH
XP400 PRO

EXPANDED KEY PROGRAMMING ACCESSORIES



- Supports over 10 key unlock types
- BMW EWS3 key learning
- Mercedes-Benz NEC key learning
- Mercedes-Benz ESL_W209 read/write/erase
- Compatible with IM508, IM508S, IM608 PRO, IM608PROII (XP400 PRO required)
- Includes 1-Year Warranty

IMMO ACCESSORIES

G-BOX3

- Mercedes-Benz All Keys Lost, Faster Password Calculation
- Mercedes-Benz All Keys Lost, eliminates repeated Insertions within the process
- Mercedes-Benz All Keys Lost, Can Be Programmed on the Vehicle Without Removing the Electronic Ignition Switch (EIS)
- BMW DME/DDE ISN Reading and Writing in Boot Mode or Bench Method
- Contains All Connections Including Cables, Fuse Connector, and CAN Line Connectors

APB112

- Smart key emulator
- Compatible with IM608, IM508 & MX808IM
- Compatible with XP400 for 4D transponder functions
- 46, 4D data collection
- Smart key password calculation (Hyundai/Kia 46)
- 46 chip simulation
- Toyota 4D (94/D4, 98) smart key emulation
- Toyota H (88/A8, A9, 39) smart key emulation
- Collects data from ignition coil
- Identify ignition coil troubles
- Decode vehicle key chip data
- Simulate vehicle key chip (ex - 4D chip)
- Compatible with Autel diagnostic tools
- Toyota/Lexus smart key all key lost
- Chip decoding (Hyundai 46)



G-BOX3

All Keys Lost password calculations are up to 8x faster

Compatible with the MaxiIM IM508, IM508S, IM608PRO & IM608PROII

Supports on-vehicle and on-bench Fast Mode in an All Keys Lost scenario for Mercedes-Benz vehicles using the DAS3 EIS/EZS

*The IM508 tablets require the purchase of the XP400PRO Key Programmer to use the G-Box3.

APB112



Smart Key Emulator

Chip Decoding

Use with XP400 for 4D transponder functions

Compatible with the MaxiIM IM508, IM508S, IM608PRO & IM608proII

Toyota/Lexus Smart Key All Key Lost

46, 4D Data Collection

VIEW
ON OUR
WEBSITE



MAXITPMS

COMPLETE TPMS SERVICE WITH ALL SYSTEMS DIAGNOSTICS & SERVICE

ACTIVE TESTS &
SPECIAL FUNCTIONS

PRE & POST-SCAN
REPORTING

WORKS WITH TESLA BLE
SENSORS & AUTEL
BLUETOOTH SENSORS
P/N #300100



ONE TOOL. EVERYTHING TPMS.

FEATURES

COMPLETE TPMS SOLUTION

- Activate, Read, and Relearn all known TPMS sensors
- Program AUTEL MX-Sensors to replace 99% of TPMS sensors on the vehicles on the road today
- Industry-leading Relearn-by-OBD vehicle coverage
- Single Screen TPMS Health Report
- Compatible with Autel's new Tesla-ready and programmable BLE-001 Bluetooth TPMS sensors

DIAGNOSTICS & SERVICE

- Perform Bi-directional Active Tests and Special Functions. Extensive Service Menu with direct access to over 40 maintenance tasks
- Generate Detailed Pre- and Post-Scan Reports, Wi-Fi sharing and printing

VIEW
ON OUR
WEBSITE



TS900



WI-FI SOFTWARE UPDATES



TS900K-8 SENSOR KIT

Includes 8 1-Sensors
P/N: 700300



1.8GHz
Quad-Core



11
Android OS

Android 11 Operating System

Compatible with Tesla TPMS Sensors

Bi-Directional Active Tests

Extensive Service Menu

Program Autel Bluetooth MX-Sensors

2 MX-Sensor Programming Methods



8.1
1280x800
Touchscreen



SSD
64G Memory



TPMS SYSTEM STATUS

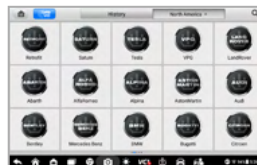

VEHICLE COVERAGE



MX-SENSOR PROGRAMMING

MAXITPMS

COMPLETE TIRE SERVICE POWERED BY AUTEL DIAGNOSTICS

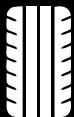

NEW EXPANDED TIRE FEATURES
DOT TIRE REGISTRATION
& RECALL LOOKUP

*OBDMS SOFTWARE REQUIRES ADDITIONAL SOFTWARE SUBSCRIPTION PURCHASE.



4 SERVICE FUNCTIONS
OLS / EPB / BMS / SAS

WORKS WITH TESLA BLE
SENSORS & AUTEL
BLUETOOTH SENSORS

P/N #300100



FREE

Wi-Fi Software Updates
for the Life of the Tool

Not Applicable for ITS600PRO

FAST & ACCURATE VEHICLE ID

AutoVIN, Scan VIN
& Plate Scan

COMPLETE TIRE SERVICE



P/N: ITSUPDATE
ITS600 PRO UPGRADE
 EXPAND DIAGNOSTIC & SERVICE FUNCTIONS

- All System AutoSCAN & Diagnostics
- 20+ Service Functions
- Read/Clear All System Codes / View Live Data
- 1 Year of FREE Diagnostics Updates
- 1 Year of FREE Service Updates

ALREADY INCLUDED WITH ITS600

- Complete TPMS Functionality
- 4 Service Functions: OLS / BMS / SAS / EPB

P/N: 700150

ITS600 PRO

GET ALL THE EXPANDED DIAGNOSTIC & SERVICE FUNCTIONS WITHOUT A SEPARATE UPGRADE. ALL INCLUDED IN ONE PURCHASE.

WI-FI SOFTWARE UPDATES

MULTIPLE KIT OPTIONS AVAILABLE! CONTACT YOUR AUTEL DISTRIBUTOR



ITS600 SENSOR KIT

Includes 8 I-Sensors
 P/N: 700130

EXPANDED TIRE SERVICE WITH TBE200



More Info Pages 4 & 5

ITS600



5.5-Inch Screen



DIAGNOSTICS & SERVICE

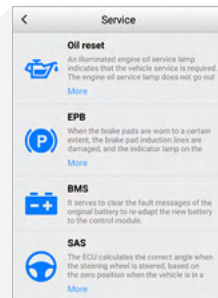

BATTERY TESTING SOFTWARE AVAILABLE
 Additional Purchase of BT506 required

QUICK VEHICLE ID TECHNOLOGY

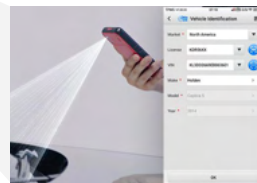

Rapid VIN Acquisition Via Optical Scan VIN

QR Code Scan / Barcode Scan, Plate Scan, Auto VIN Detect and Manual Input

Identify MMY and Sensor OE Part Number Via VIN Decoding

Optical Scanner Identifies VIN/MMY

Exclusive TPMS Status Screen

Industry-leading OBDII-Relearn coverage

4 Common Service Resets

2 MX-Sensor Programming Methods

Read & Relearn All Brand Sensors



VIEW THIS ON OUR WEBSITE



BLUETOOTH SENSOR

ADJUSTABLE-ANGLE SENSOR

15°-34° for a more secure fit for a broader range of vehicles.



P/N: 300100

Tesla-Ready Pre-Programmed

OE-Level Functionality

Compatible With Tesla 3, Y, S, And X Models

6 Years Of Battery Life

Automotive-Grade Bluetooth Processor

15°-34° Adjustable-Angle Sensor

Programmable for new vehicles with Bluetooth TPMS for smarter, more connected tires.



WATCH THE VIDEO

1-SENSOR

ONLY 1-SKU TYPE

AUTEL MX-SENSORS MUST BE PROGRAMMED AT ZERO PSI IF ALREADY INSTALLED



OE QUALITY SENSOR
315 MHz + 433 MHz
COMBINE BOTH FREQUENCIES

99%

VEHICLE COVERAGE

RUBBER / ALUMINUM INTERCHANGEABLE VALVE STEMS



TS508WF



MULTIPLE KIT
OPTIONS AVAILABLE!
CONTACT YOUR
AUTEL DISTRIBUTOR

SENSOR KIT AVAILABLE

TS508WFKMV-1

INCLUDES 8 1-SENSORS
& 1 METAL VALVE KIT
P/N: 700060



P/N: 700010



Read & Relearn All Brand Sensors 2 MX-Sensor Programming Methods

FREE Updates for Life of Tool Tire Pressure Placard Value Reset

Exclusive TPMS Status Screen Display Relearn Procedures



320x240
LED Color Display



OBDII Cable



WiFi
Updates

REAL-TIME TIRE HEALTH ANALYSIS WHEN USED WITH ITS600

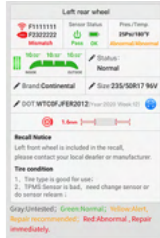

TBE200



MAGNETIC STAND
INCLUDED

1.65-INCH SCREEN

COMPREHENSIVE TEST REPORT



Tread wear analysis:
In good condition.
Maintenance
suggestion: The tire
is in good condition. It
can be driven about X
kilometers more.
Please check it on a
regular basis.

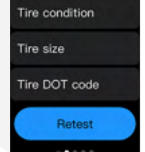

Measurement Data Curve Display / Uneven Wear Analysis

Detailed Replacement & Maintenance Suggestions

Test Detail For Single Tire Tread / Brake Disc



1.65" AMOLED
Super Retina
Touchscreen



1MP Macro
Camera



8MP Zoom
Camera

MAXIBAS

BATTERY AND ELECTRICAL SYSTEM DIAGNOSTICS & SERVICE



SAVE TIME AND MONEY
WITH A SINGLE WORKFLOW AND TOOL



IMPROVE CUSTOMER LOYALTY
WITH A SAFER AND MORE THOROUGH SERVICE



INCREASE RECURRING REVENUE
WITH BATTERY & ALL-SYSTEM HEALTH CHECKS



BATTERY/SYSTEM ANALYZER

FEATURES

VEHICLE IDENTIFICATION

- Best Vehicle Coverage With Over 50 Vehicle Makes
- Lists OE Batteries by Model
- Offers Battery Location Diagrams

BMS RESET FUNCTIONALITY

- Clear Instructions To Reset Vehicle Systems
- Perform Battery Registrations With Ease

ADAPTIVE CONDUCTANCE

- Improves Accuracy
- Diagnose Low-Capacity Batteries
- Reduces Charge & Retest

CALCULATE YOUR
BATTERY SERVICE
REVENUE
POTENTIAL ▶



SYSTEM DIAGNOSTICS

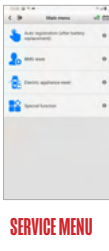
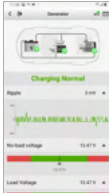

SERVICE MENU

BATTERY DIAGNOSIS

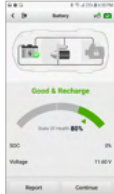

REPLACEMENT DIAGRAMS

BT608



VCI200

BT609



7-INCH SCREEN



VCI200



1-YR FREE SOFTWARE

RENEWAL COST OF JUST \$12450
EXTENDS TABLET WARRANTY
TOTAL CARE PROGRAM (TCP)



Built-in Thermal Printer	Temperature Compensation
AutoSCAN All System Diagnostics	Electrical Reset
Battery Health Report	Read & Erase Codes



BT508



One Vehicle Brand / Make Included

Test All 6 / 12V Starting Batteries

Add Makes Via In-App Purchases

Test 12 / 24V Starting & Charging Systems

Easy Annual Renewal Fee Process

Read/Erase Codes on Chosen Makes

*Not compatible with any other Autel tools.

BT506



Perfect for DIY Users

Test All 6 / 12V Starting Batteries

Compatible with ITS600 & MaxiSYS Tablets

Test 12 / 24V Starting & Charging Systems

Includes Battery Interface Only

VCI Not Included w/BT506



FREE SMARTPHONE APP

Download the free and easy-to-use mobile app, available for iOS and Android devices



BT506

Already have an Autel MaxiSYS tablet? The **MaxiBAS BT506** is the ultimate battery, starting and charging systems testing upgrade for existing Autel MaxiSYS tablets, and is a powerful app-based standalone battery and electrical system tester. Powered by the free Autel IOS or Android app.



RECOMMENDED ACCESSORIES:



BATTERY TESTER MEMORY SAVER

Save time by preserving vehicle codes and electronic presets when replacing batteries. Connect to the vehicle via OBDII and a 12 volt backup battery with the included alligator clips.



VCIEXTCAB OBDII EXTENSION CABLE

Extend your OBDII cable and never lose another VCI. Compatible with all OBDII-compliant VCIs.



BTAK MULTIMETER & CURRENT CLAMP

The BTAK enables technicians to safely and easily troubleshoot vehicle electrical systems and components.



CALCULATE YOUR BATTERY SERVICE REVENUE POTENTIAL

Scan the QR code or visit autel.com/us/battery-service and see how 5-minute Battery and All-system Health Checks can improve your bottom line.

AUTOLINK

ADVANCED CODE READERS

WHAT'S INCLUDED IN AUTOLINK TOOLS?

QUICK ACCESS VEHICLE ID
NUMBER INFORMATION

AUTO VIN

+

SEARCH DEFINITION LIBRARY
FOR CODE INFORMATION

DTC LOOKUP

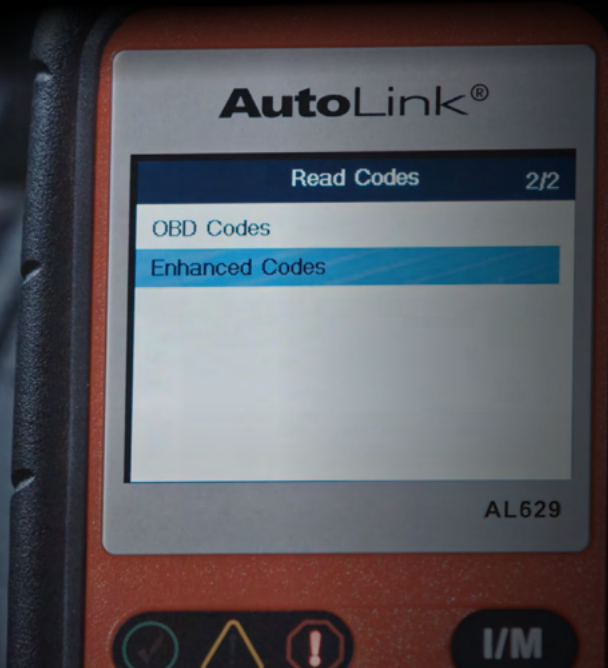

COMPLETE DIY SOLUTION

FEATURES



Support All 10 OBDII Test Modes
AL629, AL529HD

1-Touch I/M Readiness
AL329, AL529HD

Graph, Record & Playback Live Data
AL629, AL529HD

Enhanced Mode 6 Diagnostics
AL629, AL529HD

Test: O₂ Monitor/Sensor & On-Board Monitor
AL629, AL529HD

VIEW
ON OUR
WEBSITE



AL629

Read/Eraser Engine & Transmission DTCs*

Read/Eraser ABS & SRS DTCs



Read/Eraser DTCs
Engine



Read/Eraser DTCs
ABS



Read/Eraser DTCs
SRS



Read/Eraser DTCs
Transmission

FREE SOFTWARE | *Manufacturer specific and OBDII DTCs



AL529HD

Read/Eraser Heavy Duty Engine DTCs

Read/Eraser Power System Codes*



Read/Eraser DTCs
Engine



Heavy Duty



FREE SOFTWARE



AL329

Read/Eraser Engine DTCs



Read/Eraser DTCs
Engine

FREE SOFTWARE



HOW TO UPDATE:

Your AL329 or AL629 with MaxiPC Suite

QUICK ACCESS TO VEHICLE
ID NUMBER INFORMATION

SEARCH DTC DEFINITION LIBRARY
FOR CODE BREAKER INFORMATION

FEATURES

INCLUDED IN ALL NEW TOOLS

READ & CLEAR CODES

Domestic, Asian and European
Vehicles 1996 and Newer



AUTO VIN + DTC LOOKUP



P0021

\$07E8 Generic

A Camshaft Position Timing
Over - Advanced or System
Performance Bank 2

ALL CURRENT AUTOLINK MODELS
CONTAIN THE FOLLOWING FEATURES

- Auto-VIN 2006+*
- Color LED Display 320 x 240

- I/M Readiness / Emissions Testing
- Live & Freeze Frame Data

- OBDII 16-Pin Cable
- Read MIL Status

- 1-Year Tool Warranty
- FREE Software Downloads for the life of the tool

*Manufacturer-Specific Codes: AL629

MAXIVIDEO

DIGITAL INSPECTION VIDEOSCOPIES & ACCESSORIES



DIGITAL INSPECTION SCOPES

FEATURES

ADJUSTABLE LED LIGHT



DIGITAL ZOOM



OIL & SCRATCH RESISTANT



VIEW
ON OUR
WEBSITE



MV480



Side & Front Cameras

7x Digital Zoom

2 Megapixel Resolution

Adjustable LED Light

1-Button Photo/Video

Audio Annotation



SIDE LED LIGHT SIDE CAMERA FRONT CAMERA & LED LIGHT

MV460



Side & Front Cameras

7x Digital Zoom

2 Megapixel Resolution

Adjustable LED Light

1-Button Photo/Video

Audio Annotation



FRONT CAMERA & LED LIGHT

LIMITED WARRANTY

REGISTER AND UPDATE YOUR TOOLS FOR UP-TO-DATE VEHICLE COVERAGE

STANDARD POLICY

Autel guarantees to the original end-user that its products are free from defects in material and workmanship for a specified period of time depending on the product.

Autel will repair or replace warranted products at its discretion:

- Replaced products will either be new or re-certified
- All re-certified products will be tested to ensure their hardware and software are functionally equivalent to new products

DO NOT OPEN OR DISASSEMBLE AUTEL PRODUCTS:

- Opening and/or disassembling an Autel product will void the product's warranty
- Contact Autel Tech Support for assistance

This limited warranty does not apply to:

- Product with a cracked screen, broken case, chemical exposure or liquid damage
- Damaged product due to accident, abuse, misuse, natural disaster, insufficient or excessive electrical supply, abnormal mechanical or environmental conditions or unauthorized disassembly, repair or modification
- Consumable parts, such as batteries or protective coatings that are designed to diminish over time, unless failure has occurred due to a defect in materials or workmanship
- Product not used in accordance with accompanying instructions or intended use

STANDARD PROCEDURE

- Any defective products require a Return Goods Authorization (RGA) number from Autel to be serviced
- Contact Autel Tech Support to obtain an RGA number
- The end-user is responsible for the cost of insuring and shipping products to Autel for repair or replacement
- Autel will cover the return shipping cost of the repaired or replacement tool with the same delivery speed by which it was received
- Tools must be properly packaged to prevent damage during transit
- The Autel RGA number must be prominently displayed on the outside of the package
- Packaged received by Autel without the RGA number prominently displayed will be returned, unopened
- Autel cannot guarantee the security of a unit that is shipped without an Autel-issued RGA

WARRANTY INFORMATION

The tools and accessories in this catalog are covered under the Autel Limited Warranty for ONE (1) YEAR from date of tool purchase.

FREE SOFTWARE UPDATES

Any tool that has Android software gets 1 year of free software and a 1-year limited warranty. The following tools are eligible for free software updates for ONE (1) YEAR from date of tool registration.

- **MaxiSYS MSULTRAEV**
- **MaxiSYS MS909EV**
- **MaxiSYS MSULTRA**
- **MaxiSYS MS919**
- **MaxiSYS MS909**
- **MaxiSYS MS906PRO**
- **MaxiSYS MS906PRO-TS**
- **MaxiCHECK MX900**
- **MaxiSYS MS909CV**
- **MaxiSYS MS908CVII**
- **MaxiIM IM608PROIIKPA**
- **MaxiIM IM508S**
- **MaxiTPMS TS900**
- **MaxiTPMS ITS600PRO**
- **MaxiBAS BT609**

The following tools are eligible for free software updates for the LIFETIME OF THE TOOL from date of tool registration.

- **MaxiFLASH VCMII**
- **MaxiFLASH VCI**
- **MaxiDIAG MD808 PRO**
- **MaxiIM KM100**
- **MaxiIM XP400 PRO**
- **MaxiIM APB112**
- **MaxiIM G-Box3**
- **MaxiTPMS ITS600**
- **MaxiTPMS TBE200**
- **MaxiTPMS TS508WF**
- **MaxiBAS BT608**
- **MaxiBAS BT508**
- **MaxiBAS BT506**
- **AutoLINK AL629**
- **AutoLINK AL529HD**
- **AutoLINK AL329**
- **MaxiVIDEO MV480**
- **MaxiVIDEO MV460**

MAXISYS

MaxiCheck

MaxiIM

MaxiTPMS

MaxiBAS

AutoLink

MaxiVideo

Autel North America

Email: ussupport@autel.com
36 Harbor Park Drive,
Port Washington, NY 11050, U.S.

Autel Europe

Email: support.eu@autel.com
Adalperstraße 82, 85737
Ismaning, Germany

Autel China HQ

Email: support@autel.com
7th, 8th and 10th Floor, Building B1, Zhiyuan,
Xueyuan Road, Xili, Nanshan, Shenzhen,
518055, China

Autel Latin America

Email: latsupport@autel.com
Avenida Americas 1905, 6B,
Colonia Aldrete, Guadajajara,
Jalisco, Mexico

Autel APAC

Email: support.jp@autel.com
719, Nissou Building, 3-7-18, Shinyokohama,
Kohoku, Yokohama, Kanagawa, Japan
222-0033

Autel IMEA DMCC

Email: imea-support@autel.com
Office 1006-1010, Cluster C, Fortune Tower,
Jumeirah Lakes Tower (JLT), Dubai, U.A.E



AUTEL ACADEMY TECHNICAL TRAINING

Visit autel.com/us/academy and register today for hands on automotive diagnostic, repair, service, and ADAS instruction.

SCAN TO
VISIT OUR
WEBSITE



AUTEL

1.855.288.3587 | AUTEL.COM | FOLLOW US @AUTELTOOLS